



Pricelist 2021

Sitting + Positioning.



smilla.
04-07



madita.
08-13



madita-fun.
14-19



madita-fun mini.
20-22



madita hd.
24-27



madita maxi.
28-30



sofie.
32-37



activity chair.
38-41



tina.
42-44

Transport + Travelling.



sascha.
46-47



siggi combi isofix.
48-49



siggi 3 fix.
50-51



freddy.
52-55



floyd.
56-59



fridolin 1.
60-62



fridolin 2.
64-66



fridolin maxi.
68-69



franka.
70-72



tom 5 streeter.
74-77



corzo x-country.
78-79



piper.
80-81

new
in stock

Content.

Walking + Riding.



malte.
82-84



malte outdoor.
86-87



marcy.
88-89



dynamic pacer.
90-95



momo tricycle.
96-101



follow-me momo.
102-103



momo motion.
104-110



momo therapy bike.
112-118

Standing + Transfer.



till.
120-125



todd.
126-131



tim.
132-135



hip.
136-137



tram.
138-139

Bathroom + Toilet.



boris.
140-141



hts.
142-145



wave.
146-147



basti.
148-149



bibi.
150

General information.



Name embroidery.
151



Flexi-activ harnesses.
152-155



Fabric collection.
156-157



Cleaning + disinfection.
158-159

smilla.

Invoice address:
Dispatch address:
 See invoice address

 Order
 Cost estimate

Customer No.: _____

Orderer: _____

Date: _____

Signature: _____

Commission:
The convenient seating aid for everyday use.



- Sturdy wooden frame with integrated aluminium profiles
- Incl. height adjustable backrest and adjustable back angle
- Incl. seat and back pad
- Incl. height adjustable armrests
- Incl. height, angle and depth adjustable seat and footplate
- Incl. positioning castors
- Material: varnished beech

HMV-No.: 26.11.05.0034
Dimensions - basic model

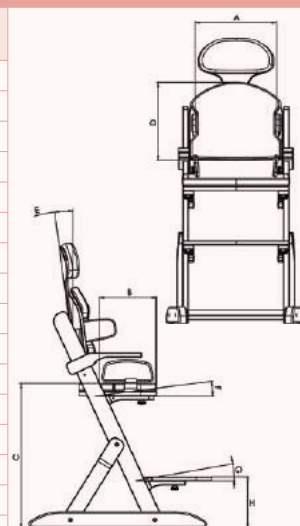
		Size 0 Nursery	Size 0	Size 1 Nursery	Size 1	Size 2
A	Seat width	17 - 28 cm	17 - 28 cm	20 - 35 cm	20 - 35 cm	30 - 40 cm
B	Seat depth	16 - 26 cm	16 - 26 cm	25 - 35 cm	25 - 35 cm	30 - 40 cm
C	Max. seat height	45 cm	65 cm	45 cm	65 cm	65 cm
D	Back height	25 cm	25 cm	29 cm	29 cm	34 cm
E	Back angle	(-) 3° - 17.5°				
F	Tilt-in-space	(-) 5°, 0°, 7.5°, 15°				
G	Foot angle	(-) 5°, 0°, 7.5°, 15°				
H*	Min. footplate height	Standard	13 cm			
		with 50 mm dual castors	18 cm			
		with 75 mm dual castors	21 cm			
H*	Min. footplate height (with quick angle adjustment)	Standard	8 cm			
		with 50 mm dual castors	13 cm			
		with 75 mm dual castors	16 cm			
	Max. load	30 kg	30 kg	45 kg	45 kg	60 kg
	Weight	9.2 kg	9.7 kg	9.6 kg	10.2 kg	12 kg





Basic model		
smilla. size 0	smilla. size 1	smilla. size 2
Price / piece	Price / piece	Price / piece
<input type="checkbox"/> Size 0 Nursery (13 00 100) 1.081 €	<input type="checkbox"/> Size 1 Nursery (13 01 100) 1.081 €	<input type="checkbox"/> Size 2 (13 02 000) 1.295 €
<input type="checkbox"/> Size 0 (13 00 000) 1.081 €	<input type="checkbox"/> Size 1 (13 01 000) 1.081 €	

Frame colours	
Beech natural	Beech white
	
Price	Price
<input type="checkbox"/> 92 00 300 incl.	<input type="checkbox"/> 92 00 301 incl.

Covers					
Pink 2 (No. 115)	Azur (No. 110)	Green (No. 89)	Dark Grey (No. 92)	Flexi Blue (No. 44)	Name embroidery on the back pad
					please fill out the form on page 15! An embroidery of Flexi fabrics is not possible.
Price	Price	Price	Price	Upcharge	
<input type="checkbox"/> 91 00 115 incl.	<input type="checkbox"/> 91 00 110 incl.	<input type="checkbox"/> 91 00 089 incl.	<input type="checkbox"/> 91 00 092 incl.	<input type="checkbox"/> 91 00 044 225 €	

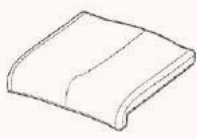
Accessories					
Headrest – padded and height adjustable	Lateral pads – padded and adjustable		Thigh guides – padded and adjustable		
					
Adjustable height (in 3 cm steps)	Width 1	Width 2	Length	Height	
for size 0+1 12 - 21cm	for size 0 13 - 19 cm	for size 1 17 - 23 cm	Size 0 17.5 cm	7 cm	
for size 2 20.5 - 32.5 cm	for size 1 20 - 26 cm	for size 2 24 - 30 cm	Size 1 20 cm	8.5 cm	
	for size 2 24 - 30 cm		Size 2 22.5 cm	10 cm	
Price / piece	Price / pair		Price / pair		
<input type="checkbox"/> for size 0 (13 00 001) 242 €	<input type="checkbox"/> Width 1 (13 01 002) 158 €	<input type="checkbox"/> Width 2 (13 01 003) 158 €	<input type="checkbox"/> Size 0 (13 00 004) 203 €	<input type="checkbox"/> Size 1 (13 01 004) 203 €	
<input type="checkbox"/> for size 1 (13 01 001) 242 €			<input type="checkbox"/> Size 2 (13 02 004) 203 €		
<input type="checkbox"/> for size 2 (13 02 001) 242 €					

Configuration options - seat	
Standard seat pad – incl. cover (standard configuration, if nothing else stated)	Seat pad – incl. cover with anatomic leg guidance
	
Price / piece	Upcharge / piece
<input type="checkbox"/> for size 0 (13 00 021) Incl.	<input type="checkbox"/> for size 0 (13 00 022) 199 €
<input type="checkbox"/> for size 1 (13 01 021) Incl.	<input type="checkbox"/> for size 1 (13 01 022) 199 €
<input type="checkbox"/> for size 2 (13 02 021) Incl.	<input type="checkbox"/> for size 2 (13 02 022) 199 €

Accessories

Quick angle adjustment of the footplate and seat – allows quick and easy angle adjustment of the footplate and seat to (-) 5°, 0°, 7.5° and 15° by straps (not possible in connection with quick height adjustment)



Upcharge / set

- for size 0 **(13 00 090)**
- for size 1 **(13 01 090)**
- for size 2 **(13 02 090)**

 247 €
247 €
247 €

Quick height adjustment for footplate, seat and back – allows quick and easy height adjustment of the footplate, seat and back (not possible in connection with quick angle adjustment)



Upcharge / set

- 13 00 020**

62 €

Accessories

Wooden therapy tray – plug-on



	Width	Depth
for size 0	48cm	37cm
for size 1	52cm	39cm
for size 2	57cm	39cm

Price / piece

- for size 0 **(19 00 005)** 236 €
- for size 1 **(19 01 005)** 236 €
- for size 2 **(19 02 005)** 236 €

Large Wooden therapy tray – plug-on, with edge



	Width	Depth
for size 0	48cm	45cm
for size 1	52cm	49cm
for size 2	57cm	49cm

Price / piece

- for size 0 **(19 00 009)** 262 €
- for size 1 **(19 01 009)** 262 €
- for size 2 **(19 02 009)** 262 €

Abduction wedge – padded and pluggable



Price / piece

- for size 0 **(19 00 008)** 198 €
- for size 1+2 **(19 01 008)** 198 €

Accessories

Dual castors – 4 pieces

Price / set

- 50 mm – 2 with locking devices **(13 01 006)** 262 €
- 50 mm – all with locking devices **(13 01 016)** 294 €
- 75 mm – 2 with locking devices **(13 00 006)** 262 €
- 75 mm – all with locking devices **(13 00 016)** 294 €

Harness

The **smilla.** harness is assembled with the following harness assembly sets.

Further positioning aids and configuration options can be found from page 152.

If a colour is not selected, we will use black as the standard colour for your order.

Harness assembly kit for the seat
consisting of 2 brackets with clip buckle and 2 clip buckles (drilled)



Price / set

- 20 mm **(19 00 010)** 39 €
- 25 mm **(19 01 010)** 39 €

Harness assembly kit for the back
consisting of belt holder with T-groove incl. 2 clip buckles and 2 clip buckles (drilled)



Price / set

- 20 mm **(19 00 011)** 134 €
- 25 mm **(19 01 011)** 134 €

Harness
Chest-shoulder strap – made of elastic, breathable and moisture repellent material, three straps with clips, sewn strap to the left shoulder

Positioning jacket – with zipper, made of elastic, breathable material, shoulder straps sewn at back, pelvis straps with clips

	Size 0	Size 1	Size 2	Size 3
A	13cm	13cm	18cm	18cm
B	17.5cm	19cm	20cm	21cm
C	15cm	15cm	19cm	28cm
D	3.5cm	5cm	5cm	5cm
E	25.5cm	28cm	34cm	44cm
Strap width	2cm	2cm	2.5cm	2.5cm
		Price / piece		Colour
<input type="checkbox"/> Size 0 (1300025)			160 €	<input type="checkbox"/> Black (9100040)
<input type="checkbox"/> Size 1 (1301025)			160 €	<input type="checkbox"/> Light grey (9100049)
<input type="checkbox"/> Size 2 (1302025)			160 €	
<input type="checkbox"/> Size 3 (1303025)			160 €	



	Size 0	Size 1	Size 2	
A	11cm	11cm	18cm	
B	21cm	21cm	22cm	
C	12cm	12cm	15cm	
D	2.5cm	3.5cm	3.5cm	
E	25.5cm	28cm	34cm	
Strap width	2cm	2cm	2.5cm	
		Price / piece		Colour
<input type="checkbox"/> Size 0 (1300026)			185 €	<input type="checkbox"/> Black (9100040)
<input type="checkbox"/> Size 1 (1301026)			185 €	<input type="checkbox"/> Light grey (9100049)
<input type="checkbox"/> Size 2 (1302026)			185 €	



Harness
T-shape groin harness – made of elastic, breathable and moisture repellent material, with two clips at front, straps sewn at back

Groin harness (standard) – made of elastic, breathable and moisture repellent material, with two clips at front, straps sewn at back

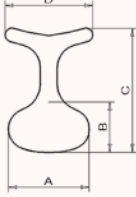
	Size 0	Size 1	Size 2	
A	23cm	25cm	28cm	
B	15cm	17cm	20cm	
C	33cm	35cm	38cm	
D	24cm	26cm	28cm	
Strap width	2cm	2cm	2.5cm	
		Price / piece		Colour
<input type="checkbox"/> Size 0 (1300027)			133 €	<input type="checkbox"/> Black (9100040)
<input type="checkbox"/> Size 1 (1301027)			133 €	<input type="checkbox"/> Light grey (9100049)
<input type="checkbox"/> Size 2 (1302027)			133 €	

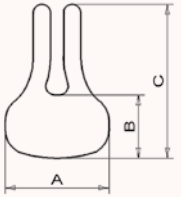

	Size 1	Size 2	Size 3	
A	24cm	29cm	33cm	
B	14cm	17cm	22cm	
C	35cm	43cm	49cm	
Strap width	2cm	2.5cm	2.5cm	
		Price / piece		Colour
<input type="checkbox"/> Size 1 (1301028)			133 €	<input type="checkbox"/> Black (9100040)
<input type="checkbox"/> Size 2 (1302028)			133 €	<input type="checkbox"/> Light grey (9100049)
<input type="checkbox"/> Size 3 (1303028)			133 €	

Harness
Pelvic harness – with pad and adjustable clip on both sides

	Size 0	Size 1	Size 2	
Pad width	4cm	4cm	5cm	
Pad length per side	16cm	18cm	28cm	
Strap length per side	30cm	30cm	40cm	
Strap width	2cm	2.5cm	2.5cm	
		Price / piece		Colour
<input type="checkbox"/> Size 0 (1300029)			80 €	<input type="checkbox"/> Black (9100040)
<input type="checkbox"/> Size 1 (1301029)			80 €	<input type="checkbox"/> Light grey (9100049)
<input type="checkbox"/> Size 2 (1302029)			80 €	

Harness
4-point pelvic harness – with pad and adjustable clip on both sides

	Size 0	Size 1	Size 2	
Pad width	4cm	4cm	5cm	
Pad length per side	16cm	18cm	28cm	
Strap length per side	30cm	30cm	40cm	
Strap width	2cm	2.5cm	2.5cm	
		Price / piece		Colour
<input type="checkbox"/> Size 0 (1300030)			139 €	<input type="checkbox"/> Black (9100040)
<input type="checkbox"/> Size 1 (1301030)			139 €	<input type="checkbox"/> Light grey (9100049)
<input type="checkbox"/> Size 2 (1302030)			139 €	



madita.

Invoice address:**Dispatch address:**
 See invoice address

 Order
 Cost estimate

Customer No.: _____

Orderer: _____

Date: _____

Signature: _____

Commission:**The mobile therapy chair which grows with the child.**

- Incl. armrests, footplate with slots for Harness, push handle, standard seat pad with cover
- Adjustable seat height with gas pressure spring support
- 4 castors (75 mm), 2 with locking devices
- Adjustment options:
 - Tilt-in-space (via gas pressure spring 500N)
 - Back angle
 - Seat depth and seat width
 - Angle, height and width adjustable armrests
 - Height adjustable backrest
 - Folding footplate, knee angle, foot angle and height adjustable

HMV-No.: 26.11.05.0021
Basic model

madita. size 0		madita. size 1		madita. size 1b		madita. size 2	
Price / piece		Price / piece		Price / piece		Price / piece	
<input type="checkbox"/> 73 00 000	1.559 €	<input type="checkbox"/> 73 01 000	1.559 €	<input type="checkbox"/> 73 01 200	1.671 €	<input type="checkbox"/> 73 02 000	1.784 €
<input type="checkbox"/> with low subframe (73 00 100)	1.559 €	<input type="checkbox"/> with low subframe (73 01 100)	1.559 €				

Frame colours

Anthracit metallic		Telegrey 4 (white grey)	
<input type="checkbox"/> 92 00 014	incl.	<input type="checkbox"/> 92 00 011	incl.

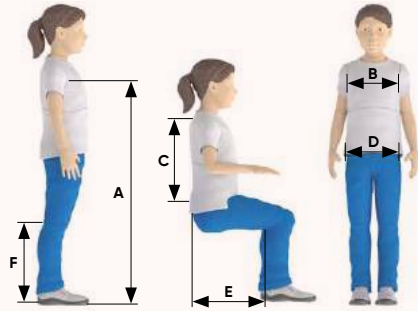
Presettings

 Presettings on the therapy chair at Schuchmann.
 Please provide us with the following body measurements:

A Axilla height	_____	D Pelvic width	_____
B Chest width	_____	E Seat depth	_____
C Back height	_____	F Lower leg length	_____

 7300080

 Price
 incl.

Dimensions - basic model

	Size 0	Size 1	Size 1b	Size 2
A Seat depth*	15-25cm	21-30cm	26-36cm	30-42cm
B Seat width	16-26cm	20-30cm	20-30cm	28-38cm
C Back height with short back	35-43cm	35-43cm	42-52cm	42-52cm
C Back height with long back	42-52cm	42-52cm	53-63cm	53-63cm
D Seat height	46-58cm	46-58cm	46-58cm	46-58cm
D Seat height with low subframe	35-40cm	35-40cm	-	-
E Lower leg length	17-25cm	20-32cm	28-40cm	26-49cm
F Total width	45cm	45cm	53cm	53cm
G Length of base frame	66cm	66cm	77cm	77cm
Tilt-in-space	(-) 5° - 37°	(-) 5° - 37°	(-) 5° - 37°	(-) 5° - 37°
Back angle	(-) 5° - 25°	(-) 5° - 25°	(-) 5° - 25°	(-) 5° - 25°
Max. load	30kg	30kg	45kg	50kg
Weight	16kg	17kg	18kg	19kg

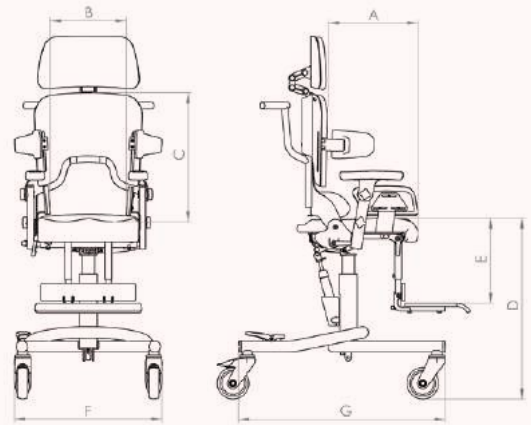

* reduced by 1 cm in combination with adjustable pelvic guide

Covers

Dark grey/ Pink (No. 92 + 114)		Dark grey/ Azur (No. 92 + 110)		Dark grey/ Deep orange (No. 92 + 107)		Dark grey/ Light blue (No. 92 + 106)	
Price		Price		Price		Price	
<input type="checkbox"/> 9100222 incl.		<input type="checkbox"/> 9100225 incl.		<input type="checkbox"/> 9100213 incl.		<input type="checkbox"/> 9100214 incl.	

Covers
Name embroidery
Minor position

Black/ Dark grey (No. 105 + 92)		Jeans (No. 116)		Name embroidery on the back pad please fill out the form on page 15! An embroidery of Flexi fabrics is not possible.		Without seat and back upholstery and cover for the installation of custom cushions
Price		Price		Price reduction		
<input type="checkbox"/> 9100205 incl.		<input type="checkbox"/> 9100116 incl.		<input type="checkbox"/> 7300059 Net -104 €		



Coated covers

Flexi Black/ Light grey (No. 43 + 50)		Flexi Black/ Red (No. 43 + 45)		Flexi Blue (No. 44)	
Upcharge		Upcharge		Upcharge	
<input type="checkbox"/> 9100226 225 €		<input type="checkbox"/> 9100227 225 €		<input type="checkbox"/> 9100044 225 €	

Configuration options - back (standard design or with integrated upper arm guide)

Back – incl. pad and cover	for size 0	for size 1	for size 1b	for size 2
Short back: Long back:	35 – 43 cm 42 – 52 cm	35 – 43 cm 42 – 52 cm	42 – 52 cm 53 – 63 cm	42 – 52 cm 53 – 63 cm
	Price / piece	Price / piece	Price / piece	Price / piece
Short standard design: Long standard design:	<input type="checkbox"/> 73 00 102 166 € <input type="checkbox"/> 73 00 103 166 €	<input type="checkbox"/> 73 01 202 166 € <input type="checkbox"/> 73 01 003 166 €	<input type="checkbox"/> 73 01 102 166 € <input type="checkbox"/> 73 01 103 166 €	<input type="checkbox"/> 73 02 002 187 € <input type="checkbox"/> 73 02 003 187 €
Short with upper arm guide: Long with upper arm guide:	<input type="checkbox"/> 73 00 129 264 € <input type="checkbox"/> 73 00 030 264 €	<input type="checkbox"/> 73 01 229 264 € <input type="checkbox"/> 73 01 030 264 €	<input type="checkbox"/> 73 01 129 264 € <input type="checkbox"/> 73 01 130 264 €	<input type="checkbox"/> 73 02 029 282 € <input type="checkbox"/> 73 02 030 282 €

Configuration options - back

Back unit – fixed (Standard configuration = with push handles, if nothing else stated)	Back unit – removable	Adjustable limitation of the back angle – to determine the individual max. back angle
		
Price / piece	Price / piece	Price / set
<input type="checkbox"/> for size 0+1 with push handles (73 01 004) incl. <input type="checkbox"/> for size 2 with push handles (73 02 004) incl. <input type="checkbox"/> for size 0+1 without push handles (73 01 005) incl. <input type="checkbox"/> for size 2 without push handles (73 02 005) incl. <input type="checkbox"/> for size 0+1 with push bar (73 01 053) incl.	<input type="checkbox"/> for size 0+1 with push handles (73 01 006) 333 € <input type="checkbox"/> for size 2 with push handles (73 02 006) 333 € <input type="checkbox"/> for size 0+1 without push handles (73 01 007) 333 € <input type="checkbox"/> for size 2 without push handles (73 02 007) 333 €	<input type="checkbox"/> 73 01 111 56 €

Headrests

Headrest (standard) padded, incl. cover, height and angle adjustable	Headrest (shell-shaped) padded, incl. cover, height and angle adjustable	Headrest (lateral guide) padded, incl. cover, height and angle adjustable	Headrest (lateral guide, angle adjustable) padded, incl. cover, height, depth and angle adjustable, side guides are each angle adjustable																
																			
Price / piece	Price / piece	Price / piece	Price / piece																
<input type="checkbox"/> for size 0 (73 00 108) 228 € <input type="checkbox"/> for size 1 (73 01 008) 228 € <input type="checkbox"/> for size 2 (73 02 008) 228 €	<input type="checkbox"/> for size 0+1 (73 01 110) 323 € <input type="checkbox"/> for size 2 (73 02 110) 323 €	<input type="checkbox"/> for size 0+1 (73 01 009) 307 € <input type="checkbox"/> for size 2 (73 02 009) 307 €	<div style="border: 1px solid black; padding: 2px; display: inline-block;">new</div> <table border="1" style="margin-top: 10px;"> <thead> <tr> <th></th> <th>A</th> <th>B</th> <th>C</th> </tr> </thead> <tbody> <tr> <td>Size 1</td> <td>13.5 cm</td> <td>10.5 cm</td> <td>10 cm</td> </tr> <tr> <td>Size 2</td> <td>15 cm</td> <td>10.5 cm</td> <td>13.5 cm</td> </tr> <tr> <td>Size 3</td> <td>17 cm</td> <td>12.5 cm</td> <td>16.5 cm</td> </tr> </tbody> </table> <p>Price / piece</p> <input type="checkbox"/> Size 1 (73 01 063) 528 € <input type="checkbox"/> Size 2 (73 02 063) 528 € <input type="checkbox"/> Size 3 (73 03 063) 528 €		A	B	C	Size 1	13.5 cm	10.5 cm	10 cm	Size 2	15 cm	10.5 cm	13.5 cm	Size 3	17 cm	12.5 cm	16.5 cm
	A	B	C																
Size 1	13.5 cm	10.5 cm	10 cm																
Size 2	15 cm	10.5 cm	13.5 cm																
Size 3	17 cm	12.5 cm	16.5 cm																

Headrests
Seat angle adjustment

Universal adapter for tailored headrests 15x15 mm	Trigger lever – mounted directly on the gas spring (standard configuration, if nothing else stated)	Trigger lever – mounted on the push bar/handle (not possible with removable back unit)
Price / piece	Price / piece	Price / piece
<input type="checkbox"/> for size 0+1 (73 01 031) 76 € <input type="checkbox"/> for size 2 (73 02 031) 76 €	<input type="checkbox"/> 73 00 085 incl.	<input type="checkbox"/> 73 01 085 incl.

Configuration possibilities - lateral pads (Step 1: Select the bracket)

Chest width – mounted on madita. size 0	Chest width – mounted on madita. size 1 + 1b	Chest width – mounted on madita. size 2	Bracket	Upcharge / pair
13 – 20 cm	16 – 23 cm	26 – 32 cm	<input type="checkbox"/> Fixed (73 00 012) <input type="checkbox"/> Flip away (73 00 013)	incl. 233 €
20 – 27 cm	23 – 30 cm	32 – 38 cm	<input type="checkbox"/> Fixed (73 01 012) <input type="checkbox"/> Flip away (73 01 013)	incl. 233 €
___ - ___ cm	___ - ___ cm	___ - ___ cm	<input type="checkbox"/> Fixed and tailored (73 09 012) <input type="checkbox"/> Flip away and tailored (73 09 013)	63 € 296 €

(Step 2: Select the lateral pads)

	Lateral pads size 0 padded, incl. cover (standard configuration for madita. size 0, if nothing else stated) Height: 7cm Depth: 9cm	Lateral pads size 1 padded, incl. cover (standard configuration for madita. size 1, if nothing else stated) Height: 8cm Depth: 13cm	Lateral pads size 2 padded, incl. cover (standard configuration for madita. size 2, if nothing else stated) Height: 11cm Depth: 16cm	Tailored lateral pads padded, incl. cover Height: ___cm Depth: ___cm
	Price / pair	Price / pair	Price / pair	Price / pair
	<input type="checkbox"/> 7300011 95 €	<input type="checkbox"/> 7301011 95 €	<input type="checkbox"/> 7302011 95 €	<input type="checkbox"/> 7309011 187 €



(Step 2: Select the lateral pads)

	Lateral pads size 0, long (trunk guidance) padded, incl. cover Height: 13cm Depth: 7cm	Lateral pads size 1, long (trunk guidance) padded, incl. cover Height: 15cm Depth: 8cm	Lateral pads size 2, long (trunk guidance) padded, incl. cover Height: 17cm Depth: 9cm	Tailored lateral pads, long (trunk guidance) padded, incl. cover Height: ___cm Depth: ___cm
	Lateral pads (long) with flip away bracket can be folded 20° to the side.			
	Price / pair	Price / pair	Price / pair	Price / pair
<input type="checkbox"/> 7300055 167 €	<input type="checkbox"/> 7301055 167 €	<input type="checkbox"/> 7302055 167 €	<input type="checkbox"/> 7309055 259 €	

Thigh guides

	Thigh guides for size 0 padded, incl. cover, adjustable angle, depth and width 10cm = standard configuration for size 0	Thigh guides for sizes 1 + 1 b padded, incl. cover, adjustable angle, depth and width 12cm = standard configuration for sizes 1 + 1 b	Thigh guides for size 2 padded, incl. cover, adjustable angle, depth and width 17cm = standard configuration for size 2
	Price / pair	Price / pair	Price / pair
	<input type="checkbox"/> 10cm (7300114) 172 € <input type="checkbox"/> 12cm (7300115) 172 €	<input type="checkbox"/> 12cm (7301114) 172 € <input type="checkbox"/> 17cm (7301115) 172 €	<input type="checkbox"/> 17cm (7302114) 177 € <input type="checkbox"/> 22cm (7302115) 177 €

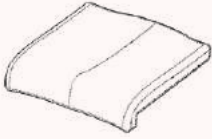
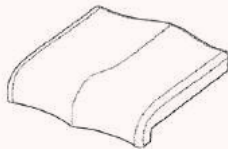
Seat option

Standard Seat pad – incl. cover (standard configuration, if nothing else stated)	Seat pad – incl. cover with anatomic leg guidance	Adjustable pelvic guidance – padded, incl. cover
		
Price / piece	Upcharge / piece	Price / piece
<input type="checkbox"/> for size 0 (7300018) incl. <input type="checkbox"/> for size 1 (7301018) incl. <input type="checkbox"/> for size 1 b (7301118) incl. <input type="checkbox"/> for size 2 (7302018) incl.	<input type="checkbox"/> for size 0 (7300019) 195 € <input type="checkbox"/> for size 1 (7301019) 195 € <input type="checkbox"/> for size 1 b (7301119) 195 € <input type="checkbox"/> for size 2 (7302019) 195 €	<input type="checkbox"/> for size 0 – seat width A = 15 – 24cm (7300021) 345 € <input type="checkbox"/> for size 1 + 1 b – seat width A = 18 – 28cm (7301021) 345 € <input type="checkbox"/> for size 2 – seat width A = 26 – 36cm (7302021) 365 €

Seat option

Abductable leg guidance
with leg length compensation, padded, incl. cover (already includes thigh guides)

	for size 0	for size 1+1b	for size 2
A	0° – 20°	0° – 20°	0° – 20°
B	7 – 10cm	9 – 12cm	10 – 14cm
C	3cm	3cm	3cm

	Price / piece
<input type="checkbox"/> for size 0 (7300022) 467 € <input type="checkbox"/> for size 1 (7301022) 467 € <input type="checkbox"/> for size 1 b (7301122) 467 € <input type="checkbox"/> for size 2 (7302022) 487 €	

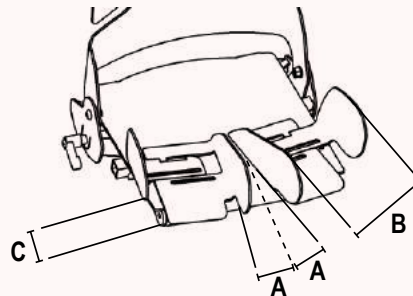

A = Abduction angle
B = Thigh width
C = Leg length compensation

Accessories

Knee abduction wedge
pluggable using quick-release axle, padded, incl. cover

	Width	Depth
Size 0	7cm	10cm
Size 1	8cm	14cm
Size 2	10cm	17cm

	Price / piece
<input type="checkbox"/> Size 0 (7300023) 202 € <input type="checkbox"/> Size 1 (7301023) 202 € <input type="checkbox"/> Size 2 (7302023) 202 €	

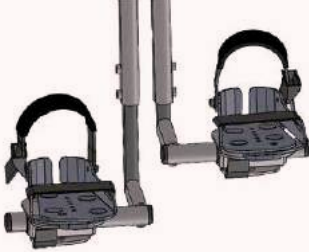

Split footplates

	Split footplates – individually adjustable, adjustable in height, width and angle, foldable, fixed to the seat unit, with non-slip surface and 4 slots (each) for attaching straps		Split footplates with foot cups individually adjustable, adjustable in height, width and angle, foldable, fixed to the seat unit																
	<table border="0"> <tr> <td colspan="2" style="text-align: right;">Upcharge / pair</td> </tr> <tr> <td><input type="checkbox"/> for size 0</td> <td>(73 00 052) 254 €</td> </tr> <tr> <td><input type="checkbox"/> for size 1</td> <td>(73 01 052) 254 €</td> </tr> <tr> <td><input type="checkbox"/> for size 1 b</td> <td>(73 01 152) 254 €</td> </tr> <tr> <td><input type="checkbox"/> for size 2</td> <td>(73 02 052) 254 €</td> </tr> </table>		Upcharge / pair		<input type="checkbox"/> for size 0	(73 00 052) 254 €	<input type="checkbox"/> for size 1	(73 01 052) 254 €	<input type="checkbox"/> for size 1 b	(73 01 152) 254 €	<input type="checkbox"/> for size 2	(73 02 052) 254 €	<table border="0"> <tr> <td colspan="2" style="text-align: right;">Upcharge / pair</td> </tr> <tr> <td><input type="checkbox"/> Size 0</td> <td>(73 00 051) 254 €</td> </tr> <tr> <td><input type="checkbox"/> Size 1</td> <td>(73 01 051) 254 €</td> </tr> <tr> <td><input type="checkbox"/> Size 2</td> <td>(73 02 051) 254 €</td> </tr> </table>	Upcharge / pair		<input type="checkbox"/> Size 0	(73 00 051) 254 €	<input type="checkbox"/> Size 1	(73 01 051) 254 €
Upcharge / pair																			
<input type="checkbox"/> for size 0	(73 00 052) 254 €																		
<input type="checkbox"/> for size 1	(73 01 052) 254 €																		
<input type="checkbox"/> for size 1 b	(73 01 152) 254 €																		
<input type="checkbox"/> for size 2	(73 02 052) 254 €																		
Upcharge / pair																			
<input type="checkbox"/> Size 0	(73 00 051) 254 €																		
<input type="checkbox"/> Size 1	(73 01 051) 254 €																		
<input type="checkbox"/> Size 2	(73 02 051) 254 €																		

Accessories

Therapy tray – made of wood with edge	Therapy tray – transparent, with edge	4 Castors – 2 with locking devices	4 Castors – all with locking devices																																																																																	
																																																																																				
<table border="0"> <tr> <td></td> <td style="text-align: center;">Width</td> <td style="text-align: center;">Depth</td> <td></td> <td style="text-align: center;">Width</td> <td style="text-align: center;">Depth</td> </tr> <tr> <td>for size 0+1</td> <td style="text-align: center;">50 cm</td> <td style="text-align: center;">40 cm</td> <td>for size 0+1</td> <td style="text-align: center;">50 cm</td> <td style="text-align: center;">40 cm</td> </tr> <tr> <td>for size 2</td> <td style="text-align: center;">60 cm</td> <td style="text-align: center;">50 cm</td> <td>for size 2</td> <td style="text-align: center;">60 cm</td> <td style="text-align: center;">50 cm</td> </tr> </table>		Width	Depth		Width	Depth	for size 0+1	50 cm	40 cm	for size 0+1	50 cm	40 cm	for size 2	60 cm	50 cm	for size 2	60 cm	50 cm	<table border="0"> <tr> <td></td> <td style="text-align: center;">Width</td> <td style="text-align: center;">Depth</td> <td></td> <td style="text-align: center;">Width</td> <td style="text-align: center;">Depth</td> </tr> <tr> <td>for size 0+1</td> <td style="text-align: center;">50 cm</td> <td style="text-align: center;">40 cm</td> <td>for size 0+1</td> <td style="text-align: center;">50 cm</td> <td style="text-align: center;">40 cm</td> </tr> <tr> <td>for size 2</td> <td style="text-align: center;">60 cm</td> <td style="text-align: center;">50 cm</td> <td>for size 2</td> <td style="text-align: center;">60 cm</td> <td style="text-align: center;">50 cm</td> </tr> </table>		Width	Depth		Width	Depth	for size 0+1	50 cm	40 cm	for size 0+1	50 cm	40 cm	for size 2	60 cm	50 cm	for size 2	60 cm	50 cm	<table border="0"> <tr> <td></td> <td style="text-align: center;">75 mm</td> <td style="text-align: center;">100 mm</td> <td style="text-align: center;">125 mm</td> <td></td> </tr> <tr> <td><input type="checkbox"/></td> <td>(73 00 058)</td> <td>(73 01 058)</td> <td>(73 02 058)</td> <td>incl.</td> </tr> <tr> <td><input type="checkbox"/></td> <td></td> <td></td> <td></td> <td>52 €</td> </tr> <tr> <td><input type="checkbox"/></td> <td></td> <td></td> <td></td> <td>83 €</td> </tr> </table>		75 mm	100 mm	125 mm		<input type="checkbox"/>	(73 00 058)	(73 01 058)	(73 02 058)	incl.	<input type="checkbox"/>				52 €	<input type="checkbox"/>				83 €	<table border="0"> <tr> <td></td> <td style="text-align: center;">75 mm</td> <td style="text-align: center;">100 mm</td> <td style="text-align: center;">125 mm</td> <td></td> </tr> <tr> <td><input type="checkbox"/></td> <td>(73 00 060)</td> <td>(73 01 060)</td> <td>(73 02 060)</td> <td></td> </tr> <tr> <td><input type="checkbox"/></td> <td></td> <td></td> <td></td> <td>31 €</td> </tr> <tr> <td><input type="checkbox"/></td> <td></td> <td></td> <td></td> <td>83 €</td> </tr> <tr> <td><input type="checkbox"/></td> <td></td> <td></td> <td></td> <td>114 €</td> </tr> </table>		75 mm	100 mm	125 mm		<input type="checkbox"/>	(73 00 060)	(73 01 060)	(73 02 060)		<input type="checkbox"/>				31 €	<input type="checkbox"/>				83 €	<input type="checkbox"/>				114 €
	Width	Depth		Width	Depth																																																																															
for size 0+1	50 cm	40 cm	for size 0+1	50 cm	40 cm																																																																															
for size 2	60 cm	50 cm	for size 2	60 cm	50 cm																																																																															
	Width	Depth		Width	Depth																																																																															
for size 0+1	50 cm	40 cm	for size 0+1	50 cm	40 cm																																																																															
for size 2	60 cm	50 cm	for size 2	60 cm	50 cm																																																																															
	75 mm	100 mm	125 mm																																																																																	
<input type="checkbox"/>	(73 00 058)	(73 01 058)	(73 02 058)	incl.																																																																																
<input type="checkbox"/>				52 €																																																																																
<input type="checkbox"/>				83 €																																																																																
	75 mm	100 mm	125 mm																																																																																	
<input type="checkbox"/>	(73 00 060)	(73 01 060)	(73 02 060)																																																																																	
<input type="checkbox"/>				31 €																																																																																
<input type="checkbox"/>				83 €																																																																																
<input type="checkbox"/>				114 €																																																																																
Price / piece		Upcharge / set																																																																																		
<input type="checkbox"/> for size 0 (73 00 024) 223 € <input type="checkbox"/> for size 1 (73 01 024) 223 € <input type="checkbox"/> for size 2 (73 02 024) 223 €	<input type="checkbox"/> for size 0 (73 00 037) 307 € <input type="checkbox"/> for size 1 (73 01 037) 307 € <input type="checkbox"/> for size 2 (73 02 037) 307 €	<input type="checkbox"/> 75 mm (73 00 058) incl. <input type="checkbox"/> 100 mm (73 01 058) 52 € <input type="checkbox"/> 125 mm (73 02 058) 83 €	<input type="checkbox"/> 75 mm (73 00 060) 31 € <input type="checkbox"/> 100 mm (73 01 060) 83 € <input type="checkbox"/> 125 mm (73 02 060) 114 €																																																																																	

Accessories

Wheel base extension inserts at rear, length = 10 cm (not possible together with central parking brake)	Central parking brake for rear castors incl. 4 dual castors (100 mm), operated by using the brake lever which is mounted to the seat system		Harness assembly kit for the seat – consisting of 2 brackets with clip buckle and 2 clip buckles (drilled)	Harness assembly kit for the back – consisting of 2 threaded plates with clip buckles and 2 clip buckles (drilled)																							
<table border="0"> <tr> <td></td> <td style="text-align: center;">Price / pair</td> </tr> <tr> <td><input type="checkbox"/> 73 01 028</td> <td style="text-align: center;">151 €</td> </tr> </table>		Price / pair	<input type="checkbox"/> 73 01 028	151 €	<table border="0"> <tr> <td><input type="checkbox"/> Parking lever mounted left</td> <td>(73 00 048) 381 €</td> </tr> <tr> <td><input type="checkbox"/> Parking lever mounted right</td> <td>(73 00 548) 381 €</td> </tr> <tr> <td><input type="checkbox"/> Parking lever mounted left; castors front with brakes</td> <td>(73 00 148) 412 €</td> </tr> <tr> <td><input type="checkbox"/> Parking lever mounted right; castors front with brakes</td> <td>(73 00 648) 412 €</td> </tr> </table>	<input type="checkbox"/> Parking lever mounted left	(73 00 048) 381 €	<input type="checkbox"/> Parking lever mounted right	(73 00 548) 381 €	<input type="checkbox"/> Parking lever mounted left; castors front with brakes	(73 00 148) 412 €	<input type="checkbox"/> Parking lever mounted right; castors front with brakes	(73 00 648) 412 €	<table border="0"> <tr> <td></td> <td style="text-align: center;">Upcharge / set</td> </tr> <tr> <td><input type="checkbox"/> 20 mm (73 00 025)</td> <td style="text-align: center;">39 €</td> </tr> <tr> <td><input type="checkbox"/> 25 mm (73 01 025)</td> <td style="text-align: center;">39 €</td> </tr> </table>		Upcharge / set	<input type="checkbox"/> 20 mm (73 00 025)	39 €	<input type="checkbox"/> 25 mm (73 01 025)	39 €	<table border="0"> <tr> <td></td> <td style="text-align: center;">Upcharge / set</td> </tr> <tr> <td><input type="checkbox"/> 20 mm (73 00 026)</td> <td style="text-align: center;">39 €</td> </tr> <tr> <td><input type="checkbox"/> 25 mm (73 01 026)</td> <td style="text-align: center;">39 €</td> </tr> </table>		Upcharge / set	<input type="checkbox"/> 20 mm (73 00 026)	39 €	<input type="checkbox"/> 25 mm (73 01 026)	39 €
	Price / pair																										
<input type="checkbox"/> 73 01 028	151 €																										
<input type="checkbox"/> Parking lever mounted left	(73 00 048) 381 €																										
<input type="checkbox"/> Parking lever mounted right	(73 00 548) 381 €																										
<input type="checkbox"/> Parking lever mounted left; castors front with brakes	(73 00 148) 412 €																										
<input type="checkbox"/> Parking lever mounted right; castors front with brakes	(73 00 648) 412 €																										
	Upcharge / set																										
<input type="checkbox"/> 20 mm (73 00 025)	39 €																										
<input type="checkbox"/> 25 mm (73 01 025)	39 €																										
	Upcharge / set																										
<input type="checkbox"/> 20 mm (73 00 026)	39 €																										
<input type="checkbox"/> 25 mm (73 01 026)	39 €																										

Accessories

Incontinence coating in the seat area	Padded cover for footplate – covered with black flexi cover, height: 3 cm (not possible in combination with foot straps)	Padded cover for split footplate covered with black flexi cover, height: 3 cm (not possible in combination with foot straps)	Table upholstery – covered with black flexi cover, height: 1 cm																						
																									
<table border="0"> <tr> <td></td> <td style="text-align: center;">Price / piece</td> </tr> <tr> <td><input type="checkbox"/> 73 00 020</td> <td style="text-align: center;">176 €</td> </tr> </table>		Price / piece	<input type="checkbox"/> 73 00 020	176 €	<table border="0"> <tr> <td><input type="checkbox"/> for size 0</td> <td>(73 00 038) 99 €</td> </tr> <tr> <td><input type="checkbox"/> for size 1</td> <td>(73 01 038) 99 €</td> </tr> <tr> <td><input type="checkbox"/> for size 2</td> <td>(73 02 038) 99 €</td> </tr> </table>	<input type="checkbox"/> for size 0	(73 00 038) 99 €	<input type="checkbox"/> for size 1	(73 01 038) 99 €	<input type="checkbox"/> for size 2	(73 02 038) 99 €	<table border="0"> <tr> <td><input type="checkbox"/> for size 0</td> <td>(73 00 039) 127 €</td> </tr> <tr> <td><input type="checkbox"/> for size 1</td> <td>(73 01 039) 127 €</td> </tr> <tr> <td><input type="checkbox"/> for size 2</td> <td>(73 02 039) 127 €</td> </tr> </table>	<input type="checkbox"/> for size 0	(73 00 039) 127 €	<input type="checkbox"/> for size 1	(73 01 039) 127 €	<input type="checkbox"/> for size 2	(73 02 039) 127 €	<table border="0"> <tr> <td><input type="checkbox"/> for size 0</td> <td>(73 00 054) 112 €</td> </tr> <tr> <td><input type="checkbox"/> for size 1</td> <td>(73 01 054) 112 €</td> </tr> <tr> <td><input type="checkbox"/> for size 2</td> <td>(73 02 054) 112 €</td> </tr> </table>	<input type="checkbox"/> for size 0	(73 00 054) 112 €	<input type="checkbox"/> for size 1	(73 01 054) 112 €	<input type="checkbox"/> for size 2	(73 02 054) 112 €
	Price / piece																								
<input type="checkbox"/> 73 00 020	176 €																								
<input type="checkbox"/> for size 0	(73 00 038) 99 €																								
<input type="checkbox"/> for size 1	(73 01 038) 99 €																								
<input type="checkbox"/> for size 2	(73 02 038) 99 €																								
<input type="checkbox"/> for size 0	(73 00 039) 127 €																								
<input type="checkbox"/> for size 1	(73 01 039) 127 €																								
<input type="checkbox"/> for size 2	(73 02 039) 127 €																								
<input type="checkbox"/> for size 0	(73 00 054) 112 €																								
<input type="checkbox"/> for size 1	(73 01 054) 112 €																								
<input type="checkbox"/> for size 2	(73 02 054) 112 €																								

Harness

The **madita.**-harness is assembled with the harness assembly sets (see page 12). Further fixing aids and configuration options can be found starting on page 152. If a colour is not selected, we will use black as the standard colour for your order.

Harness

Chest-shoulder strap – made of elastic, breathable and moisture repellent material, three straps with clips, sewn strap to the left shoulder

	Size 0	Size 1	Size 2	Size 3
A	13cm	13cm	18cm	18cm
B	17.5cm	19cm	20cm	21cm
C	15cm	15cm	19cm	28cm
D	3.5cm	5cm	5cm	5cm
E	25.5cm	28cm	34cm	44cm
Strap width	2cm	2cm	2.5cm	2.5cm

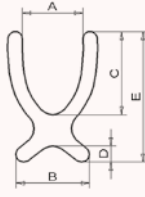

Positioning jacket – with zipper, made of elastic, breathable material, shoulder straps sewn at back, pelvis straps with clips

	Size 0	Size 1	Size 2
A	11cm	11cm	18cm
B	21cm	21cm	22cm
C	12cm	12cm	15cm
D	2.5cm	3.5cm	3.5cm
E	25.5cm	28cm	34cm
Strap width	2cm	2cm	2.5cm

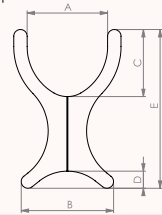

	Price / piece	Colour
<input type="checkbox"/> Size 0 (73 00 032)	160 €	<input type="checkbox"/> Black (91 00 040)
<input type="checkbox"/> Size 1 (73 01 032)	160 €	<input type="checkbox"/> Light grey (91 00 049)
<input type="checkbox"/> Size 2 (73 02 032)	160 €	
<input type="checkbox"/> Size 3 (73 03 032)	160 €	

	Price / piece	Colour
<input type="checkbox"/> Size 0 (73 00 056)	185 €	<input type="checkbox"/> Black (91 00 040)
<input type="checkbox"/> Size 1 (73 01 056)	185 €	<input type="checkbox"/> Light grey (91 00 049)
<input type="checkbox"/> Size 2 (73 02 056)	185 €	

Harness

T-shape groin harness – made of elastic, breathable and moisture repellent material, with two clips at front, straps sewn at back

	Size 0	Size 1	Size 2
A	23cm	25cm	28cm
B	15cm	17cm	20cm
C	33cm	35cm	38cm
D	24cm	26cm	28cm
Strap width	2cm	2cm	2.5cm

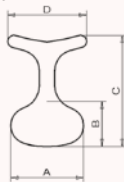

Groin harness (standard) – made of elastic, breathable and moisture repellent material, with two clips at front, straps sewn at back

	Size 1	Size 2	Size 3
A	24cm	29cm	33cm
B	14cm	17cm	22cm
C	35cm	43cm	49cm
Strap width	2cm	2.5cm	2.5cm

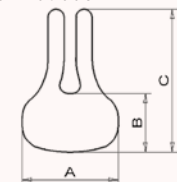

	Price / piece	Colour
<input type="checkbox"/> Size 0 (73 00 033)	133 €	<input type="checkbox"/> Black (91 00 040)
<input type="checkbox"/> Size 1 (73 01 033)	133 €	<input type="checkbox"/> Light grey (91 00 049)
<input type="checkbox"/> Size 2 (73 02 033)	133 €	

	Price / piece	Colour
<input type="checkbox"/> Size 1 (73 01 034)	133 €	<input type="checkbox"/> Black (91 00 040)
<input type="checkbox"/> Size 2 (73 02 034)	133 €	<input type="checkbox"/> Light grey (91 00 049)
<input type="checkbox"/> Size 3 (73 03 034)	133 €	

Harness

Pelvic harness – with pad and adjustable clip on both sides

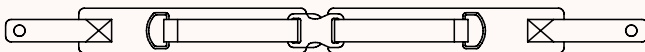

	Size 0	Size 1	Size 2
Pad width	4cm	4cm	5cm
Pad length per side	16cm	18cm	28cm
Strap length per side	30cm	30cm	40cm
Strap width	2cm	2.5cm	2.5cm

	Price / piece	Colour
<input type="checkbox"/> Size 0 (73 00 035)	80 €	<input type="checkbox"/> Black (91 00 040)
<input type="checkbox"/> Size 1 (73 01 035)	80 €	<input type="checkbox"/> Light grey (91 00 049)
<input type="checkbox"/> Size 2 (73 02 035)	80 €	

4-point pelvic harness – with pad and adjustable clip on both sides

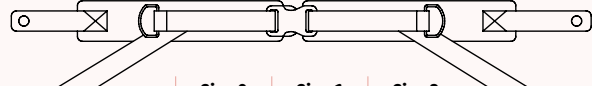

	Size 0	Size 1	Size 2
Pad width	4cm	4cm	5cm
Pad length per side	16cm	18cm	28cm
Strap length per side	30cm	30cm	40cm
Strap width	2cm	2.5cm	2.5cm

	Price / piece	Colour
<input type="checkbox"/> Size 0 (73 00 036)	139 €	<input type="checkbox"/> Black (91 00 040)
<input type="checkbox"/> Size 1 (73 01 036)	139 €	<input type="checkbox"/> Light grey (91 00 049)
<input type="checkbox"/> Size 2 (73 02 036)	139 €	

Harness

Ankle cuffs – with velcro fastener and idler pulley colour: black (not possible in combination with padded cover for footplate/split footplate)

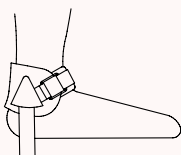

	Ankle circumference	Strap width
Size 1	12 – 19cm	25mm
Size 2	15 – 23cm	25mm
Size 3	19 – 27cm	40mm

	Price / pair
<input type="checkbox"/> Size 1 (73 01 061)	190 €
<input type="checkbox"/> Size 2 (73 02 061)	190 €
<input type="checkbox"/> Size 3 (73 03 061)	190 €

Foot positioner – with straps, incl. velcro fastener (not possible in combination with padded cover for footplate/split footplate)

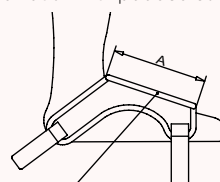

	A	Strap width
Size 1	8cm	2cm
Size 2	10cm	2cm
Size 3	13cm	2.5cm

	Price / pair
<input type="checkbox"/> Size 1 (73 01 062)	176 €
<input type="checkbox"/> Size 2 (73 02 062)	176 €
<input type="checkbox"/> Size 3 (73 03 062)	176 €

madita-fun.

Invoice address:**Dispatch address:**
 See invoice address

 Order
 Cost estimate

Customer No.: _____

Orderer: _____

Date: _____

Signature: _____

Commission:**The modern and integrative therapy chair.**

- Incl. armrests, footplate with slots for Harness, push handle, standard seat pad with cover
- Height adjustment via gas pressure spring 1200 N
- 4 castors (75 mm), 2 with locking devices
- Adjustment options:
 - Tilt-in-space (via gas pressure spring 500N)
 - Back angle
 - Seat depth and seat width
 - Angle, height and width adjustable armrests
 - Height adjustable backrest
 - Folding footplate, knee angle, foot angle and height adjustable

HMV-No.: 26.11.05.0022

Basic model

madita-fun. size 0	madita-fun. size 1	madita-fun. size 1b	madita-fun. size 2
Price / piece	Price / piece	Price / piece	Price / piece
<input type="checkbox"/> 74 00 100 2.197 €	<input type="checkbox"/> 74 01 000 2.197 €	<input type="checkbox"/> 74 01 100 2.369 €	<input type="checkbox"/> 74 02 000 2.471 €

Frame colours

Anthracit metallic	<input checked="" type="radio"/>	Telegrey 4 (white grey)	<input type="radio"/>
	Price		Price
<input type="checkbox"/> 92 00 014	incl.	<input type="checkbox"/> 92 00 011	incl.

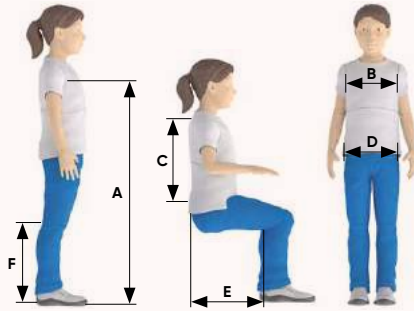
Presettings

 Presettings on the therapy chair at Schuchmann.
 Please provide us with the following body measurements:

A Axilla height	_____	D Pelvic width	_____
B Chest width	_____	E Seat depth	_____
C Back height	_____	F Lower leg length	_____

 7400080

 Price
 incl.

Dimensions - basic model

	Size 0	Size 1	Size 1b	Size 2
A Seat depth*	15 - 25 cm	21 - 30 cm	26 - 36 cm	30 - 42 cm
B Seat width	16 - 26 cm	20 - 30 cm	20 - 30 cm	28 - 38 cm
C Back height with short back	35 - 43 cm	35 - 43 cm	42 - 52 cm	42 - 52 cm
C Back height with long back	42 - 52 cm	42 - 52 cm	53 - 63 cm	53 - 63 cm
D Seat height	25 - 62 cm	25 - 62 cm	25 - 62 cm	25 - 62 cm
Seat height with electric height adjustment	32 - 62 cm	32 - 62 cm	32 - 62 cm	32 - 62 cm
Seat height with hydraulic height adjustment	27 - 63 cm	27 - 63 cm	27 - 63 cm	27 - 63 cm
E Lower leg length	17 - 25 cm	20 - 32 cm	28 - 40 cm	26 - 49 cm
F Total width	54 cm	54 cm	64 cm	64 cm
G Length of base frame	61 cm	61 cm	75 cm	75 cm
Total length with combi subframe	76 cm	76 cm	86 cm	86 cm
Tilt-in-space	(-)8° - 37°	(-)8° - 37°	(-)8° - 37°	(-)8° - 37°
Back angle	(-)5° - 25°	(-)5° - 25°	(-)5° - 25°	(-)5° - 25°
Max. load	30 kg	30 kg	45 kg	50 kg
Weight	19 kg	20 kg	22 kg	24 kg

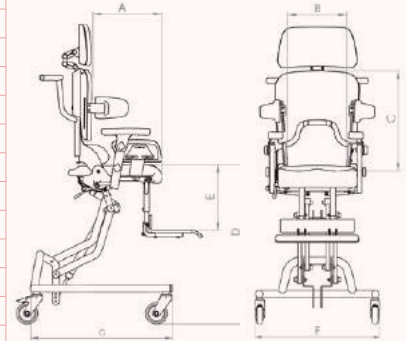

* reduced by 1 cm in combination with adjustable pelvic guide

Covers

Dark grey/ Pink-Telemagenta (No. 92 + 114)		Dark grey/ Azur (No. 92 + 110)		Dark grey/ Deep orange (No. 92 + 107)		Dark grey/ Light blue (No. 92 + 106)	
Price		Price		Price		Price	
<input type="checkbox"/> 9100222 incl.		<input type="checkbox"/> 9100225 incl.		<input type="checkbox"/> 9100213 incl.		<input type="checkbox"/> 9100214 incl.	

Covers
Name embroidery
Minor position

Black/ Dark grey (No. 105 + 92)		Jeans (No. 116)		Name embroidery on the back pad please fill out the form on page 15! An embroidery of Flexi fabrics is not possible.		Without seat and back upholstery and cover – for the installation of custom cushions
Price		Price		Price reduction		
<input type="checkbox"/> 9100205 incl.		<input type="checkbox"/> 9100116 incl.		<input type="checkbox"/> 7300059		Net -104 €



Coated covers

Flexi Black/ Light grey (No. 43 + 50)		Flexi Black/ Red (No. 43 + 45)		Flexi Blue (No. 44)	
Upcharge		Upcharge		Upcharge	
<input type="checkbox"/> 9100226 225 €		<input type="checkbox"/> 9100227 225 €		<input type="checkbox"/> 9100044 225 €	

Configuration options - back (Standard design or with integrated upper arm guide)

Back – incl. pad and cover	for size 0	for size 1	for size 1b	for size 2
Short back: Long back:	35 – 43 cm 42 – 52 cm	35 – 43 cm 42 – 52 cm	42 – 52 cm 53 – 63 cm	42 – 52 cm 53 – 63 cm
	Price / piece	Price / piece	Price / piece	Price / piece
 Short standard design: Long standard design:	<input type="checkbox"/> 73 00 102 166 € <input type="checkbox"/> 73 00 103 166 €	<input type="checkbox"/> 73 01 202 166 € <input type="checkbox"/> 73 01 003 166 €	<input type="checkbox"/> 73 01 102 166 € <input type="checkbox"/> 73 01 103 166 €	<input type="checkbox"/> 73 02 002 187 € <input type="checkbox"/> 73 02 003 187 €
 Short with upper arm guide: Long with upper arm guide:	<input type="checkbox"/> 73 00 129 264 € <input type="checkbox"/> 73 00 030 264 €	<input type="checkbox"/> 73 01 229 264 € <input type="checkbox"/> 73 01 030 264 €	<input type="checkbox"/> 73 01 129 264 € <input type="checkbox"/> 73 01 130 264 €	<input type="checkbox"/> 73 02 029 282 € <input type="checkbox"/> 73 02 030 282 €

Configuration options - back

Back unit – fixed (standard configuration = with push handles, if nothing else stated)	Back unit – removable	Adjustable limitation of the back angle – to determine the individual max. back angle
		
Price / piece	Price / piece	Price / set
<input type="checkbox"/> for size 0+1 with push handles (73 01 004) incl. <input type="checkbox"/> for size 2 with push handles (73 02 004) incl. <input type="checkbox"/> for size 0+1 without push handles (73 01 005) incl. <input type="checkbox"/> for size 2 without push handles (73 02 005) incl. <input type="checkbox"/> for size 0+1 with push bar (73 01 053) incl.	<input type="checkbox"/> for size 0+1 with push handles (73 01 006) 333 € <input type="checkbox"/> for size 2 with push handles (73 02 006) 333 € <input type="checkbox"/> for size 0+1 without push handles (73 01 007) 333 € <input type="checkbox"/> for size 2 without push handles (73 02 007) 333 €	<input type="checkbox"/> 73 01 111 56 €

Headrests

Headrest (standard) padded, incl. cover, height and angle adjustable	Headrest (shell-shaped) padded, incl. cover, height and angle adjustable	Headrest (lateral guide) padded, incl. cover, height and angle adjustable	Headrest (lateral guide, angle adjustable) padded, incl. cover, height, depth and angle adjustable, side guides are each angle adjustable																
																			
Price / piece	Price / piece	Price / piece	Price / piece																
<input type="checkbox"/> for size 0 (73 00 108) 228 € <input type="checkbox"/> for size 1 (73 01 008) 228 € <input type="checkbox"/> for size 2 (73 02 008) 228 €	<input type="checkbox"/> for size 0+1 (73 01 110) 323 € <input type="checkbox"/> for size 2 (73 02 110) 323 €	<input type="checkbox"/> for size 0+1 (73 01 009) 307 € <input type="checkbox"/> for size 2 (73 02 009) 307 €	<table border="1"> <thead> <tr> <th></th> <th>A</th> <th>B</th> <th>C</th> </tr> </thead> <tbody> <tr> <td>Size 1</td> <td>13.5 cm</td> <td>10.5 cm</td> <td>10 cm</td> </tr> <tr> <td>Size 2</td> <td>15 cm</td> <td>10.5 cm</td> <td>13.5 cm</td> </tr> <tr> <td>Size 3</td> <td>17 cm</td> <td>12.5 cm</td> <td>16.5 cm</td> </tr> </tbody> </table> Price / piece <input type="checkbox"/> Size 1 (73 01 063) 528 € <input type="checkbox"/> Size 2 (73 02 063) 528 € <input type="checkbox"/> Size 3 (73 03 063) 528 €		A	B	C	Size 1	13.5 cm	10.5 cm	10 cm	Size 2	15 cm	10.5 cm	13.5 cm	Size 3	17 cm	12.5 cm	16.5 cm
	A	B	C																
Size 1	13.5 cm	10.5 cm	10 cm																
Size 2	15 cm	10.5 cm	13.5 cm																
Size 3	17 cm	12.5 cm	16.5 cm																

Headrests
Seat angle adjustment

Universal adapter for tailored headrests 15x15 mm	Trigger lever – mounted directly on the gas spring (standard configuration, if nothing else stated)	Trigger lever – mounted on the push bar/handle (not possible with removable back unit)
Price / piece	Price / piece	Price / piece
<input type="checkbox"/> for size 0+1 (73 01 031) 76 € <input type="checkbox"/> for size 2 (73 02 031) 76 €	<input type="checkbox"/> 74 00 085 incl.	<input type="checkbox"/> 74 01 085 incl.

Configuration possibilities - lateral pads (Step 1: Select the bracket)

Chest width – mounted on madita-fun. size 0	Chest width – mounted on madita-fun. size 1 + 1b	Chest width – mounted on madita-fun. size 2	Bracket	Upcharge / pair
13 – 20 cm	16 – 23 cm	26 – 32 cm	<input type="checkbox"/> Fixed (73 00 012) <input type="checkbox"/> Flip away (73 00 013)	incl. 233 €
20 – 27 cm	23 – 30 cm	32 – 38 cm	<input type="checkbox"/> Fixed (73 01 012) <input type="checkbox"/> Flip away (73 01 013)	incl. 233 €
___ – ___ cm	___ – ___ cm	___ – ___ cm	<input type="checkbox"/> Fixed and tailored (73 09 012) <input type="checkbox"/> Flip away and tailored (73 09 013)	63 € 296 €

(Step 2: Select the lateral pads)

	Lateral pads size 0 padded, incl. cover (standard configuration for madita-fun. size 0, if nothing else stated) Height: 7cm Depth: 9cm	Lateral pads size 1 padded, incl. cover (standard configuration for madita-fun. size 1, if nothing else stated) Height: 8cm Depth: 13cm	Lateral pads size 2 padded, incl. cover (standard configuration for madita-fun. size 2, if nothing else stated) Height: 11cm Depth: 16cm	Tailored lateral pads padded, incl. cover Height: ___cm Depth: ___cm
	Price / pair		Price / pair	
	<input type="checkbox"/> 73 00 011 95 €	<input type="checkbox"/> 73 01 011 95 €	<input type="checkbox"/> 73 02 011 95 €	<input type="checkbox"/> 73 09 011 187 €





(Step 2: Select the lateral pads)

	Lateral pads size 0, long (trunk guidance) padded, incl. cover Height: 13cm Depth: 7cm	Lateral pads size 1, long (trunk guidance) padded, incl. cover Height: 15cm Depth: 8cm	Lateral pads size 2, long (trunk guidance) padded, incl. cover Height: 17cm Depth: 9cm	Tailored lateral pads, long (trunk guidance) padded, incl. cover Height: ___cm Depth: ___cm
	Lateral pads (long) with flip away bracket can be folded 20° to the side.			
	Price / pair		Price / pair	
<input type="checkbox"/> 73 00 055 167 €	<input type="checkbox"/> 73 01 055 167 €	<input type="checkbox"/> 73 02 055 167 €	<input type="checkbox"/> 73 09 055 259 €	

Thigh guides

	Thigh guides for size 0 padded, incl. cover, adjustable angle, depth and width 10cm = standard configuration for size 0	Thigh guides for sizes 1 + 1 b padded, incl. cover, adjustable angle, depth and width 12cm = standard configuration for sizes 1 + 1 b	Thigh guides for size 2 padded, incl. cover, adjustable angle, depth and width 17cm = standard configuration for size 2
	Price / pair		Price / pair
	<input type="checkbox"/> 10cm (73 00 114) 172 €	<input type="checkbox"/> 12cm (73 01 114) 172 €	<input type="checkbox"/> 17cm (73 02 114) 177 €
<input type="checkbox"/> 12cm (73 00 115) 172 €	<input type="checkbox"/> 17cm (73 01 115) 172 €	<input type="checkbox"/> 22cm (73 02 115) 177 €	

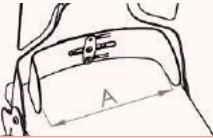
Seat option

Standard Seat pad – incl. cover (standard configuration, if nothing else stated) 	Seat pad – incl. cover with anatomic leg guidance 	Adjustable pelvic guidance padded, incl. cover 	
Price / piece	Upcharge / piece	Price/piece	
<input type="checkbox"/> for size 0 (73 00 018) incl.	<input type="checkbox"/> for size 0 (73 00 019) 195 €	<input type="checkbox"/> for size 0 – Seat width A = 15 – 24 cm (73 00 021)	345 €
<input type="checkbox"/> for size 1 (73 01 018) incl.	<input type="checkbox"/> for size 1 (73 01 019) 195 €	<input type="checkbox"/> for size 1 + 1 b – Seat width A = 18 – 28 cm (73 01 021)	345 €
<input type="checkbox"/> for size 1 b (73 01 118) incl.	<input type="checkbox"/> for size 1 b (73 01 119) 195 €	<input type="checkbox"/> for size 2 – Seat width A = 26 – 36 cm (73 02 021)	365 €
<input type="checkbox"/> for size 2 (73 02 018) incl.	<input type="checkbox"/> for size 2 (73 02 019) 195 €		

Seat option

Abductable leg guidance – with leg length compensation, padded, incl. cover (already includes thigh guides)

	for size 0	for size 1+1b	for size 2
A	0° – 20°	0° – 20°	0° – 20°
B	7 – 10 cm	9 – 12 cm	10 – 14 cm
C	3 cm	3 cm	3 cm
	Price / piece		
<input type="checkbox"/> for size 0 (73 00 022)			467 €
<input type="checkbox"/> for size 1 (73 01 022)			467 €
<input type="checkbox"/> for size 1 b (73 01 122)			467 €
<input type="checkbox"/> for size 2 (73 02 022)			487 €

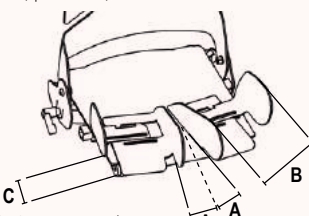

A = Abduction angle
B = Thigh width
C = Leg length compensation

Accessories

Knee abduction wedge – pluggable, using quick-release axle, padded, incl. cover

	Width	Depth
Size 0	7 cm	10 cm
Size 1	8 cm	14 cm
Size 2	10 cm	17 cm
	Price / piece	
<input type="checkbox"/> Size 0 (73 00 023)	202 €	
<input type="checkbox"/> Size 1 (73 01 023)	202 €	
<input type="checkbox"/> Size 2 (73 02 023)	202 €	





Split footplates

Split footplates – individually adjustable, adjustable in height, width and angle, foldable, fixed to the seat unit, with non-slip surface and 4 slots (each) for attaching straps 	Split footplates with foot cups – individually adjustable, adjustable in height, width and angle, foldable, fixed to the seat unit 
Upcharge / pair	
<input type="checkbox"/> for size 0 (73 00 052) 254 €	<input type="checkbox"/> Size 0 (73 00 051) 254 €
<input type="checkbox"/> for size 1 (73 01 052) 254 €	<input type="checkbox"/> Size 1 (73 01 051) 254 €
<input type="checkbox"/> for size 1 b (73 01 152) 254 €	<input type="checkbox"/> Size 2 (73 02 051) 254 €
<input type="checkbox"/> for size 2 (73 02 052) 254 €	



Accessories

Therapy tray – made of wood, with edge 			Therapy tray – transparent, with edge 			4 Castors – 2 with locking devices 			4 Castors – all with locking devices 		
	Width	Depth		Width	Depth						
for size 0+1	50 cm	40 cm	for size 0+1	50 cm	40 cm						
for size 2	60 cm	50 cm	for size 2	60 cm	50 cm						
Price / piece			Price / piece			Upcharge / set			Upcharge / set		
<input type="checkbox"/> for size 0	(73 00 024)	223 €	<input type="checkbox"/> for size 0	(73 00 037)	307 €	<input type="checkbox"/> 75 mm	(73 00 058)	incl.	<input type="checkbox"/> 75 mm	(73 00 060)	31 €
<input type="checkbox"/> for size 1	(73 01 024)	223 €	<input type="checkbox"/> for size 1	(73 01 037)	307 €	<input type="checkbox"/> 100 mm	(73 01 058)	52 €	<input type="checkbox"/> 100 mm	(73 01 060)	83 €
<input type="checkbox"/> for size 2	(73 02 024)	223 €	<input type="checkbox"/> for size 2	(73 02 037)	307 €	<input type="checkbox"/> 125 mm	(73 02 058)	83 €	<input type="checkbox"/> 125 mm	(73 02 060)	114 €

Accessories

Central parking brake for rear castors – incl. 4 dual castors (100 mm), operated by using the brake lever which is mounted to the seat system 				Conversion kit for combi subframe complete with 12 1/2" wheels, screw-in axles, drum brake, steering wheels 6" and push bar 			
				Price / set			
<input type="checkbox"/> for size 0+1	Parking lever mounted left		(74 01 051)	381 €			
<input type="checkbox"/> for size 0+1	Parking lever mounted right		(74 01 551)	381 €			
<input type="checkbox"/> for size 1b+2	Parking lever mounted left		(74 02 051)	381 €			
<input type="checkbox"/> for size 1b+2	Parking lever mounted right		(74 02 551)	381 €			
<input type="checkbox"/> for size 0+1	Parking lever mounted left - castors front with brakes		(74 01 151)	412 €			
<input type="checkbox"/> for size 0+1	Parking lever mounted right - castors front with brakes		(74 01 651)	412 €			
<input type="checkbox"/> for size 1b+2	Parking lever mounted left - castors front with brakes		(74 02 151)	412 €			
<input type="checkbox"/> for size 1b+2	Parking lever mounted right - castors front with brakes		(74 02 651)	412 €			
				Price / set			
				<input type="checkbox"/> for size 0+1	(74 01 001)	765 €	
				<input type="checkbox"/> for size 1b+2	(74 02 001)	765 €	

Accessories

Hydraulic height adjustment Retrofitting not possible! Not possible together with the conversion kit for combi subframe! 		Electric height adjustment by a 24 Volt electric motor 		Additional gas dampers (2 pcs) to support the lift function (not possible in combination with the hydraulic or electric height adjustment!) 2x 300 N recommended from 30 kg load 2x 500 N recommended from 40 kg load		Anti tip – adjustable in height 	
Upcharge / set		Price / set		Price / set		Price / piece	
<input type="checkbox"/> for size 0+1	(74 01 050) 460 €	<input type="checkbox"/> 74 00 002	805 €	<input type="checkbox"/> 2x 300 N	(74 00 003) 107 €	<input type="checkbox"/> 74 00 004 (for standard & electric height adjustment)	230 €
<input type="checkbox"/> for size 1b+2	(74 02 050) 460 €			<input type="checkbox"/> 2x 500 N	(74 01 003) 107 €	<input type="checkbox"/> 74 01 004 (for hydr. height adjustment)	230 €

Accessories

Wheel base extension insertable, inserts at front, length = 10 cm 		Incontinence coating in the seat area 		Harness assembly kit for the seat consisting of 2 brackets with clip buckle and 2 clip buckles (drilled)		Harness assembly kit for the back consisting of 2 threaded plates with clip buckles and 2 clip buckles (drilled)	
Price / set		Price / piece		Price / set		Price / set	
<input type="checkbox"/> 74 00 005	151 €	<input type="checkbox"/> 73 00 020	176 €	<input type="checkbox"/> 20 mm	(73 00 025) 39 €	<input type="checkbox"/> 20 mm	(73 00 026) 39 €
				<input type="checkbox"/> 25 mm	(73 01 025) 39 €	<input type="checkbox"/> 25 mm	(73 01 026) 39 €

Cover

Padded footplate cover – covered with black flexi cover, height: 3 cm (not possible in combination with foot straps) 		Padded cover for split footplate – covered with black flexi cover, height: 3 cm (not possible in combination with foot straps) 		Padded tray cover – covered with black flexi cover, height: 1 cm 	
Price / piece		Price / piece		Price / piece	
<input type="checkbox"/> for size 0	(73 00 038) 99 €	<input type="checkbox"/> for size 0	(73 00 039) 127 €	<input type="checkbox"/> for size 0	(73 00 054) 112 €
<input type="checkbox"/> for size 1	(73 01 038) 99 €	<input type="checkbox"/> for size 1	(73 01 039) 127 €	<input type="checkbox"/> for size 1	(73 01 054) 112 €
<input type="checkbox"/> for size 2	(73 02 038) 99 €	<input type="checkbox"/> for size 2	(73 02 039) 127 €	<input type="checkbox"/> for size 2	(73 02 054) 112 €

Harness

The **madita-fun.**-harness is assembled with the harness assembly sets (see page 18). Further fixing aids and configuration options can be found from page 152. If a colour is not selected, we will use black as the standard colour for your order.

Harness

Chest-shoulder strap – made of elastic, breathable and moisture repellent material, three straps with clips, sewn strap to the left shoulder

	Size 0	Size 1	Size 2	Size 3
A	13cm	13cm	18cm	18cm
B	17.5cm	19cm	20cm	21cm
C	15cm	15cm	19cm	28cm
D	3.5cm	5cm	5cm	5cm
E	25.5cm	28cm	34cm	44cm
Strap width	2cm	2cm	2.5cm	2.5cm



	Price / piece	Colour
<input type="checkbox"/> Size 0 (73 00 032)	160 €	<input type="checkbox"/> Black (91 00 040)
<input type="checkbox"/> Size 1 (73 01 032)	160 €	<input type="checkbox"/> Light grey (91 00 049)
<input type="checkbox"/> Size 2 (73 02 032)	160 €	
<input type="checkbox"/> Size 3 (73 03 032)	160 €	

Positioning jacket – with zipper, made of elastic, breathable material, shoulder straps sewn at back, pelvis straps with clips

	Size 0	Size 1	Size 2
A	11cm	11cm	18cm
B	21cm	21cm	22cm
C	12cm	12cm	15cm
D	2.5cm	3.5cm	3.5cm
E	25.5cm	28cm	34cm
Strap width	2cm	2cm	2.5cm

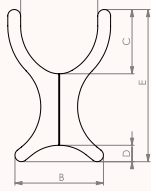

	Price / piece	Colour
<input type="checkbox"/> Size 0 (73 00 056)	185 €	<input type="checkbox"/> Black (91 00 040)
<input type="checkbox"/> Size 1 (73 01 056)	185 €	<input type="checkbox"/> Light grey (91 00 049)
<input type="checkbox"/> Size 2 (73 02 056)	185 €	

Harness

T-shape groin harness – made of elastic, breathable and moisture repellent material, with two clips at front, straps sewn at back

	Size 0	Size 1	Size 2
A	23cm	25cm	28cm
B	15cm	17cm	20cm
C	33cm	35cm	38cm
D	24cm	26cm	28cm
Strap width	2cm	2cm	2.5cm



	Price / piece	Colour
<input type="checkbox"/> Size 0 (73 00 033)	133 €	<input type="checkbox"/> Black (91 00 040)
<input type="checkbox"/> Size 1 (73 01 033)	133 €	<input type="checkbox"/> Light grey (91 00 049)
<input type="checkbox"/> Size 2 (73 02 033)	133 €	

Groin harness (standard) – made of elastic, breathable and moisture repellent material, with two clips at front, straps sewn at back

	Size 1	Size 2	Size 3
A	24cm	29cm	33cm
B	14cm	17cm	22cm
C	35cm	43cm	49cm
Strap width	2cm	2.5cm	2.5cm

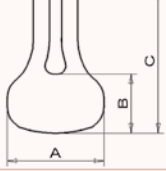

	Price / piece	Colour
<input type="checkbox"/> Size 1 (73 01 034)	133 €	<input type="checkbox"/> Black (91 00 040)
<input type="checkbox"/> Size 2 (73 02 034)	133 €	<input type="checkbox"/> Light grey (91 00 049)
<input type="checkbox"/> Size 3 (73 03 034)	133 €	

Harness

Pelvic harness – with pad and adjustable clip on both sides



	Size 0	Size 1	Size 2
Pad width	4cm	4cm	5cm
Pad length per side	16cm	18cm	28cm
Strap length per side	30cm	30cm	40cm
Strap width	2cm	2.5cm	2.5cm

	Price / piece	Colour
<input type="checkbox"/> Size 0 (73 00 035)	80 €	<input type="checkbox"/> Black (91 00 040)
<input type="checkbox"/> Size 1 (73 01 035)	80 €	<input type="checkbox"/> Light grey (91 00 049)
<input type="checkbox"/> Size 2 (73 02 035)	80 €	

4-point pelvic harness – with pad and adjustable clip on both sides

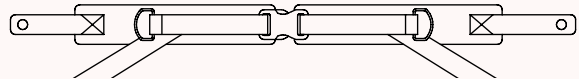

	Size 0	Size 1	Size 2
Pad width	4cm	4cm	5cm
Pad length per side	16cm	18cm	28cm
Strap length per side	30cm	30cm	40cm
Strap width	2cm	2.5cm	2.5cm

	Price / piece	Colour
<input type="checkbox"/> Size 0 (73 00 036)	139 €	<input type="checkbox"/> Black (91 00 040)
<input type="checkbox"/> Size 1 (73 01 036)	139 €	<input type="checkbox"/> Light grey (91 00 049)
<input type="checkbox"/> Size 2 (73 02 036)	139 €	

Harness

Ankle cuffs – with velcro fastener and idler pulley colour: black (not possible in combination with padded cover for footplate/split footplate)

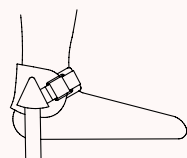

	Ankle circumference	Strap width
Size 1	12 – 19cm	25mm
Size 2	15 – 23cm	25mm
Size 3	19 – 27cm	40mm

	Price / pair
<input type="checkbox"/> Size 1 (73 01 061)	190 €
<input type="checkbox"/> Size 2 (73 02 061)	190 €
<input type="checkbox"/> Size 3 (73 03 061)	190 €

Foot positioner – with straps, incl. velcro fastener (not possible in combination with padded cover for footplate/split footplate)

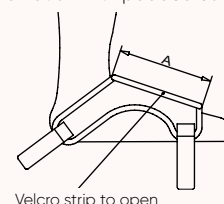

	A	Strap width
Size 1	8cm	2cm
Size 2	10cm	2cm
Size 3	13cm	2.5cm

	Price / pair
<input type="checkbox"/> Size 1 (73 01 062)	176 €
<input type="checkbox"/> Size 2 (73 02 062)	176 €
<input type="checkbox"/> Size 3 (73 03 062)	176 €

madita-fun mini.

Invoice address:
Dispatch address:
 See invoice address

 Order
 Cost estimate

Customer No.: _____

Orderer: _____

Date: _____

Signature: _____

Commission:
The therapy chair for early intervention.

- Incl. armrests, footplate with slots for harness, upholstery for footplate, ergonomically shaped push handle, standard seat pad incl. cover, 4 Castors (75 mm) – 2 with locking devices
- Height adjustable per gas pressure spring (800N)
- Frame colour: Telegrey 4 (white grey)
- Adjustment options:
 - Tilt-in-space (by gas pressure spring 250N, (-)5° - 37° / 0° - 42°)
 - Back angle
 - Seat depth and seat width
 - Armrest, height, width and angle adjustable
 - Height adjustable backrest
 - Footrest, knee angle and height adjustable

HMV-No.: 26.11.05.0022
Dimensions - basic model



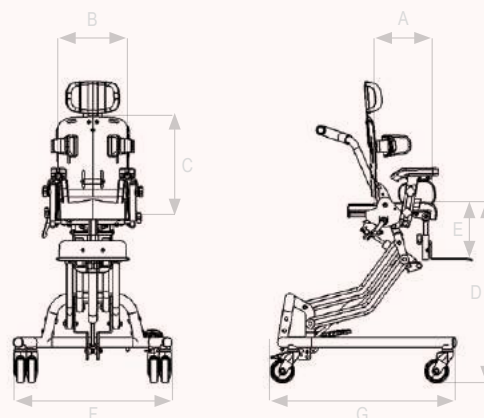

A	Seat depth	12 - 19cm
B	Seat width	14 - 22cm
C	Height short back	28 - 33cm
C	Height long back	30 - 35cm
D	Seat height	25 - 62cm
E	Lower leg length	12 - 22cm
F	Total width	52cm
G	Length of base frame	58cm
	Tilt-in-space	(-)5° - 37° / 0° - 42°
	Back angle	(-)5° - 25°
	Max. load	20kg
	Weight	16kg





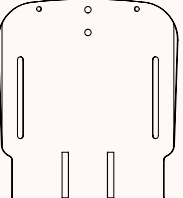
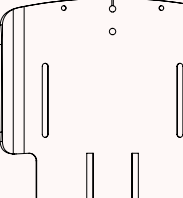

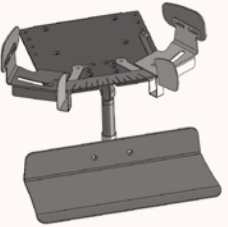

Basic model	
madita-fun mini.	
	Price / piece
<input type="checkbox"/> 3100000	2.167 €

Seat angle - default setting		
Please select a default setting ((-) ⁵ ° - 37° = standard configuration, if nothing else stated)		
	Price / piece	Price / piece
<input type="checkbox"/> (-) ⁵ ° - 37° (3100001)	incl.	<input type="checkbox"/> 0° - 42° (3100101)
	incl.	incl.

Covers					
	Pink-Telemagenta (No. 114)		Light blue (No. 106)		Jeans (No. 116)
	Price		Price		Price
<input type="checkbox"/> 9100114	incl.	<input type="checkbox"/> 9100106	incl.	<input type="checkbox"/> 9100116	incl.

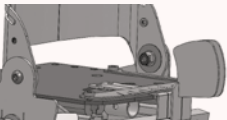
Configuration options - back																				
	Back incl. pad and cover standard			Back with integrated upper arm guidance incl. pad and cover – with adjustable hollow form in the lower trunk area through upholstery wedges (height approx. 3cm)																
		<table border="1"> <thead> <tr> <th></th> <th>Height</th> <th>Width</th> </tr> </thead> <tbody> <tr> <td>Back (short)</td> <td>28 - 33 cm</td> <td>24 cm</td> </tr> <tr> <td>Back (long)</td> <td>30 - 35 cm</td> <td>24 cm</td> </tr> </tbody> </table>		Height	Width	Back (short)	28 - 33 cm	24 cm	Back (long)	30 - 35 cm	24 cm			<table border="1"> <thead> <tr> <th></th> <th>Height</th> </tr> </thead> <tbody> <tr> <td>Back (short)</td> <td>28 - 33 cm</td> </tr> <tr> <td>Back (long)</td> <td>30 - 35 cm</td> </tr> </tbody> </table>		Height	Back (short)	28 - 33 cm	Back (long)	30 - 35 cm
	Height	Width																		
Back (short)	28 - 33 cm	24 cm																		
Back (long)	30 - 35 cm	24 cm																		
	Height																			
Back (short)	28 - 33 cm																			
Back (long)	30 - 35 cm																			
		Price / piece			Price / piece															
<input type="checkbox"/> Back (short) (3100002)		165 €	<input type="checkbox"/> Back (short) (3100005)		187 €															
<input type="checkbox"/> Back (long) (3100003)		165 €	<input type="checkbox"/> Back (long) (3100006)		187 €															
Lateral pads – padded and covered, incl. bracket		Lateral pads – long (trunk guidance) padded and covered, incl. bracket		Back without pad and cover – for the installation of custom cushions																
																				
Height	7 cm	Height	14 cm	Name embroidery on the back pad please fill out the form on page 15! An embroidery of flexi fabrics is not possible.																
Depth	9 cm	Depth	6 cm																	
Chest width	14 - 20 cm	Trunk width	14 - 20 cm																	
Price / pair		Price / pair																		
<input type="checkbox"/> 3100009	97 €	<input type="checkbox"/> 3100007	153 €	<input type="checkbox"/> 3100008	Price reduction Net -52 €															

Configuration possibilities - seat					
Seat pad – standard, incl. cover		Seat pad – with anatomic leg guidance, incl. cover			
					
Price / piece		Upcharge / piece		Upcharge / piece	
<input type="checkbox"/> 3100011	incl.	<input type="checkbox"/> 3100012	195 €	<input type="checkbox"/> 3100013	290 €
Thigh guides – padded and covered, angle, width, depth adjustable (included in dysplasia seat)		Internal guide – abductable (included in dysplasia seat)		Incontinence coating in the seat area	
					
Price / pair		Price / set		Price / piece	
<input type="checkbox"/> 13 cm (3100016)	175 €	<input type="checkbox"/> 3100015	187 €	<input type="checkbox"/> 3100014	176 €
<input type="checkbox"/> 16 cm (3100017)	175 €			<input type="checkbox"/> 3100018	Price reduction Net -52 €

Accessories

Headrest (standard) padded, height adjustable 	Headrest (standard) padded, height, depth and angle adjustable 	Headrest (shell-shaped) padded, height, depth and angle adjustable 	Therapy tray – made of wood with edge, pluggable 	Padded tray cover covered with black Flexi cover, height: 1 cm 
Price / piece	Price / piece	Price / piece	Price / piece	Price / piece
<input type="checkbox"/> 3100020 192 €	<input type="checkbox"/> 3100021 233 €	<input type="checkbox"/> 3100124 329 €	<input type="checkbox"/> 3100022 227 €	<input type="checkbox"/> 3100023 114 €

Accessories

Harness assembly kit for the seat consisting of 2 brackets with clip buckle and 2 clip buckles (drilled) Price / set <input type="checkbox"/> 3100030 39 €	Harness assembly kit for the back consisting of 2 threaded plates with clip buckles and 2 clip buckles (drilled) Price / set <input type="checkbox"/> 3100031 39 €	The madita-fun mini. harness is assembled with the harness assembly sets Further fixing aids and configuration options can be found from page 148. If a colour is not selected, we will use black as the standard colour for your order.
---	---	---

Harnessen
Harness

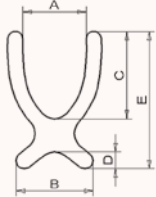
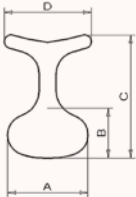
Chest-shoulder strap – made of elastic, breathable and moisture repellent material, three straps with clips, sewn strap to the left shoulder <table border="1"> <thead> <tr> <th></th> <th>Size mini</th> <th>Size 0</th> </tr> </thead> <tbody> <tr> <td>A</td> <td>8.5cm</td> <td>13cm</td> </tr> <tr> <td>B</td> <td>17.5cm</td> <td>17.5cm</td> </tr> <tr> <td>C</td> <td>14cm</td> <td>15cm</td> </tr> <tr> <td>D</td> <td>3.5cm</td> <td>3.5cm</td> </tr> <tr> <td>E</td> <td>24.5cm</td> <td>25.5cm</td> </tr> <tr> <td>Strap width</td> <td>2cm</td> <td>2cm</td> </tr> </tbody> </table> 		Size mini	Size 0	A	8.5cm	13cm	B	17.5cm	17.5cm	C	14cm	15cm	D	3.5cm	3.5cm	E	24.5cm	25.5cm	Strap width	2cm	2cm	T-shape groin harness – made of elastic, breathable and moisture repellent material, with two clips at front, straps sewn at back <table border="1"> <thead> <tr> <th></th> <th>Size mini</th> <th>Size 0</th> </tr> </thead> <tbody> <tr> <td>A</td> <td>18cm</td> <td>23cm</td> </tr> <tr> <td>B</td> <td>10cm</td> <td>15cm</td> </tr> <tr> <td>C</td> <td>25cm</td> <td>33cm</td> </tr> <tr> <td>D</td> <td>19cm</td> <td>24cm</td> </tr> <tr> <td>Strap width</td> <td>2cm</td> <td>2cm</td> </tr> </tbody> </table> 		Size mini	Size 0	A	18cm	23cm	B	10cm	15cm	C	25cm	33cm	D	19cm	24cm	Strap width	2cm	2cm
	Size mini	Size 0																																						
A	8.5cm	13cm																																						
B	17.5cm	17.5cm																																						
C	14cm	15cm																																						
D	3.5cm	3.5cm																																						
E	24.5cm	25.5cm																																						
Strap width	2cm	2cm																																						
	Size mini	Size 0																																						
A	18cm	23cm																																						
B	10cm	15cm																																						
C	25cm	33cm																																						
D	19cm	24cm																																						
Strap width	2cm	2cm																																						
Price / piece	Price / piece	Price / piece																																						
<input type="checkbox"/> Size mini (3105032) 160 € <input type="checkbox"/> Size 0 (3100032) 160 €	<input type="checkbox"/> Black (9100040) <input type="checkbox"/> Light grey (9100049)	<input type="checkbox"/> Size mini (7305033) 133 € <input type="checkbox"/> Size 0 (7300033) 133 €																																						

Harness

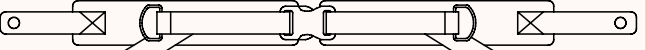
Pelvic harness – with pad and adjustable clip on both sides  <table border="1"> <thead> <tr> <th></th> <th>Size mini</th> <th>Size 0</th> </tr> </thead> <tbody> <tr> <td>Pad width</td> <td>3.5cm</td> <td>4cm</td> </tr> <tr> <td>Pad length per side</td> <td>10cm</td> <td>16cm</td> </tr> <tr> <td>Strap length per side</td> <td>20cm</td> <td>30cm</td> </tr> <tr> <td>Strap width</td> <td>2cm</td> <td>2cm</td> </tr> </tbody> </table>		Size mini	Size 0	Pad width	3.5cm	4cm	Pad length per side	10cm	16cm	Strap length per side	20cm	30cm	Strap width	2cm	2cm	4-point pelvic harness – with pad and adjustable clip on both sides  <table border="1"> <thead> <tr> <th></th> <th>Size mini</th> <th>Size 0</th> </tr> </thead> <tbody> <tr> <td>Pad width</td> <td>3.5cm</td> <td>4cm</td> </tr> <tr> <td>Pad length per side</td> <td>10cm</td> <td>16cm</td> </tr> <tr> <td>Strap length per side</td> <td>20cm</td> <td>30cm</td> </tr> <tr> <td>Strap width</td> <td>2cm</td> <td>2cm</td> </tr> </tbody> </table>		Size mini	Size 0	Pad width	3.5cm	4cm	Pad length per side	10cm	16cm	Strap length per side	20cm	30cm	Strap width	2cm	2cm
	Size mini	Size 0																													
Pad width	3.5cm	4cm																													
Pad length per side	10cm	16cm																													
Strap length per side	20cm	30cm																													
Strap width	2cm	2cm																													
	Size mini	Size 0																													
Pad width	3.5cm	4cm																													
Pad length per side	10cm	16cm																													
Strap length per side	20cm	30cm																													
Strap width	2cm	2cm																													
Price / piece	Price / piece	Price / piece																													
<input type="checkbox"/> Size mini (7305035) 80 € <input type="checkbox"/> Size 0 (7300035) 80 €	<input type="checkbox"/> Black (9100040) <input type="checkbox"/> Light grey (9100049)	<input type="checkbox"/> Size mini (7305036) 139 € <input type="checkbox"/> Size 0 (7300036) 139 €																													

Harness

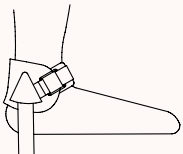
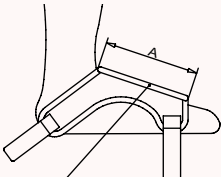
Ankle cuffs – with velcro fastener and idler pulley colour: black (not possible in combination with padded cover for footplate)  <table border="1"> <thead> <tr> <th></th> <th>Ankle circumference</th> <th>Strap width</th> </tr> </thead> <tbody> <tr> <td>Size 1</td> <td>12 – 19cm</td> <td>25mm</td> </tr> <tr> <td>Size 2</td> <td>15 – 23cm</td> <td>25mm</td> </tr> <tr> <td>Size 3</td> <td>19 – 27cm</td> <td>40mm</td> </tr> </tbody> </table>		Ankle circumference	Strap width	Size 1	12 – 19cm	25mm	Size 2	15 – 23cm	25mm	Size 3	19 – 27cm	40mm	Foot positioner – with straps, incl. velcro fastener (not possible in combination with padded cover for footplate)  <table border="1"> <thead> <tr> <th></th> <th>A</th> <th>Strap width</th> </tr> </thead> <tbody> <tr> <td>Size 1</td> <td>8cm</td> <td>2cm</td> </tr> <tr> <td>Size 2</td> <td>10cm</td> <td>2cm</td> </tr> <tr> <td>Size 3</td> <td>13cm</td> <td>2.5cm</td> </tr> </tbody> </table>		A	Strap width	Size 1	8cm	2cm	Size 2	10cm	2cm	Size 3	13cm	2.5cm
	Ankle circumference	Strap width																							
Size 1	12 – 19cm	25mm																							
Size 2	15 – 23cm	25mm																							
Size 3	19 – 27cm	40mm																							
	A	Strap width																							
Size 1	8cm	2cm																							
Size 2	10cm	2cm																							
Size 3	13cm	2.5cm																							
Price / pair	Price / pair	Price / pair																							
<input type="checkbox"/> Size 1 (7301061) 190 € <input type="checkbox"/> Size 2 (7302061) 190 € <input type="checkbox"/> Size 3 (7303061) 190 €	Velcro strip to open	<input type="checkbox"/> Size 1 (7301062) 176 € <input type="checkbox"/> Size 2 (7302062) 176 € <input type="checkbox"/> Size 3 (7303062) 176 €																							

till.

I am your adjustable inclined board.



new
Size
3 & 4

Further information can
be found from page 120.

madita hd.

Invoice address:**Dispatch address:**
 See invoice address

 Order
 Cost estimate

Customer No.: _____

Orderer: _____

Date: _____

Signature: _____

Commission:**The strong therapy chair.**

- Incl. padding (with increased safety) and cover
- Incl. armrests, footplate and push handle
- Reinforced base incl. 1x weight-bar (ca. 8 kg)
- 4 castors (75 mm) with locking devices
- Reinforced back angle adjustment
- Double-supported tilt
- Adjustment options:
 - Height adjustment via gas pressure spring (350 N)
 - Tilt-in-space
 - Back angle
 - Seat depth and width
 - Angle and width adjustable armrests
 - Knee angle and height adjustable footplate



HMV-No.: 26.11.05.0021

Basic model	
madita hd.	
	Price
<input type="checkbox"/> 30 02 100	2.135 €

Frame colours			
Anthracit metallic	<input checked="" type="radio"/>	Telegrey 4 (white grey)	<input type="radio"/>
	Price		Price
<input type="checkbox"/> 92 00 014	incl.	<input type="checkbox"/> 92 00 011	incl.

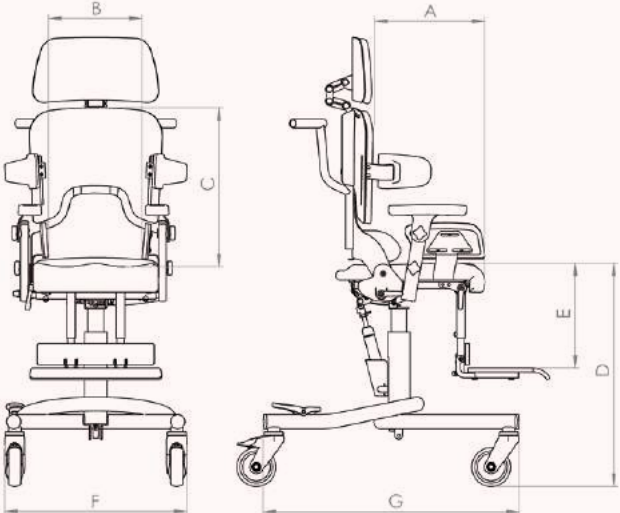
Covers				Coated cover	
	Black/ Dark grey (No. 105 + 92)		Dark grey / Deep orange (No. 92 + 107)		Dark grey / Light blue (No. 92 + 106)
	Price		Price		Price
<input type="checkbox"/> 91 00 205	incl.	<input type="checkbox"/> 91 00 213	incl.	<input type="checkbox"/> 91 00 214	incl.
					Flexi Black/ Light grey (No. 43 + 50)
					Upcharge
				<input type="checkbox"/> 91 00 226	225 €

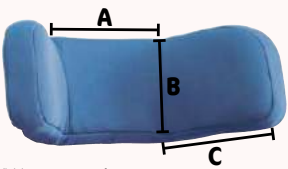
Dimensions - basic model			
		madita hd.	
A	Seat depth	30 - 42 cm	
B	Seat width	28 - 38 cm	
C	Back height with short back	42 - 52 cm	
C	Back height with long back	53 - 63 cm	
D	Seat height	46 - 58 cm	
E	Lower leg length	30 - 48 cm	
F	Total width	53 cm	
G	Length of base frame	77 cm	
	Tilt-in-space	(-)5° - 20°	
	Back angle	(-)5° - 25°	
	Max. load	65 kg	
	Weight	29 kg	

Headrest																		
Headrest with reinforced bracket, padded incl. cover, height and angle adjustable		Headrest (lateral guide, angle adjustable) – padded, incl. cover, height, depth and angle adjustable, side guides are each angle adjustable																
				<table border="1"> <thead> <tr> <th></th> <th>A</th> <th>B</th> <th>C</th> </tr> </thead> <tbody> <tr> <td>Size 1</td> <td>13.5 cm</td> <td>10.5 cm</td> <td>10 cm</td> </tr> <tr> <td>Size 2</td> <td>15 cm</td> <td>10.5 cm</td> <td>13.5 cm</td> </tr> <tr> <td>Size 3</td> <td>17 cm</td> <td>12.5 cm</td> <td>16.5 cm</td> </tr> </tbody> </table>		A	B	C	Size 1	13.5 cm	10.5 cm	10 cm	Size 2	15 cm	10.5 cm	13.5 cm	Size 3	17 cm
	A	B	C															
Size 1	13.5 cm	10.5 cm	10 cm															
Size 2	15 cm	10.5 cm	13.5 cm															
Size 3	17 cm	12.5 cm	16.5 cm															
Price / piece		Price / piece																
<input type="checkbox"/> 30 02 104	340 €	<input type="checkbox"/> Size 1 (30 01 030) 528 € <input type="checkbox"/> Size 2 (30 02 030) 528 € <input type="checkbox"/> Size 3 (30 03 030) 528 €																

Back		Lateral pads										
	Back – reinforced, incl. pad and cover	Lateral pads – with reinforced holder, padded, incl. cover		Tailored lateral pads with reinforced bracket, padded, incl. cover								
	<table border="1"> <thead> <tr> <th></th> <th>Height</th> <th>Depth</th> </tr> </thead> <tbody> <tr> <td>Short back</td> <td>42 - 52 cm</td> <td>Size 1 8 cm / 13 cm</td> </tr> <tr> <td>Long back</td> <td>53 - 63 cm</td> <td>Size 2 11 cm / 16 cm</td> </tr> </tbody> </table>		Height	Depth	Short back	42 - 52 cm	Size 1 8 cm / 13 cm	Long back	53 - 63 cm	Size 2 11 cm / 16 cm		Height: ___ cm Depth: ___ cm
		Height	Depth									
	Short back	42 - 52 cm	Size 1 8 cm / 13 cm									
Long back	53 - 63 cm	Size 2 11 cm / 16 cm										
Price / piece	Price / pair	Price / pair										
<input type="checkbox"/> short (30 02 102) 230 € <input type="checkbox"/> long (30 02 103) 230 €	<input type="checkbox"/> Size 1 (30 01 025) 155 € <input type="checkbox"/> Size 2 (30 02 025) 155 €	<input type="checkbox"/> 30 09 025 247 €										

Lateral pads			
	Lateral pads size 1, long (trunk guidance) with reinforced bracket, padded, incl. cover	Lateral pads size 2, long (trunk guidance) with reinforced bracket, padded, incl. cover	Tailored lateral pads, long (trunk guidance) with reinforced bracket, padded, incl. cover
	Height: 15 cm Depth: 8 cm	Height: 17 cm Depth: 9 cm	Height: ___ cm Depth: ___ cm
	Price / pair	Price / pair	Price / pair
	<input type="checkbox"/> 30 01 026 227 €	<input type="checkbox"/> 30 02 026 227 €	<input type="checkbox"/> 30 09 026 319 €

Configuration possibilities - seat			Minor position
Standard seat pad – incl. cover (standard configuration, if nothing else stated) 	Seat pad – incl. cover with anatomic leg guidance 	Incontinence coating – in the seat area 	Without seat and back upholstery and cover – for the installation of custom cushions.
Price / piece	Upcharge / piece	Price / piece	Price reduction
<input type="checkbox"/> 30 02 018 incl.	<input type="checkbox"/> 30 02 019 195 €	<input type="checkbox"/> 30 00 001 176 €	<input type="checkbox"/> 73 00 059 Net -104 €

Tilt-in-space adjustment		Thigh guides
Trigger lever mounted directly on the gas spring (standard configuration, if nothing else stated)	Trigger lever mounted on the push bar	Thigh guides adjustable angle, depth and width 
Price / piece	Price / piece	Price / pair
<input type="checkbox"/> 73 00 085 incl.	<input type="checkbox"/> 73 01 085 incl.	<input type="checkbox"/> 17 cm (73 02 114) 177 € <input type="checkbox"/> 22 cm (73 02 115) 177 €

Accessories						
Adjustable pelvic guidance – padded, incl. cover, seat width A = 26 - 36 cm 		Pommel – quick release, padded incl. cover 				
	Upcharge / piece	Price / piece				
<input type="checkbox"/> 73 02 021	365 €	<input type="checkbox"/> 73 02 023 202 €				
		Therapy tray – made of wood with edge, pluggable, fixed on both sides 				
		<table border="1"> <thead> <tr> <th>Width</th> <th>Depth</th> </tr> </thead> <tbody> <tr> <td>60 cm</td> <td>50 cm</td> </tr> </tbody> </table>	Width	Depth	60 cm	50 cm
Width	Depth					
60 cm	50 cm					
		Price / piece				
		<input type="checkbox"/> 30 02 023 280 €				

Accessories		
Weight ca. 8kg (max. 3 extra weights possible) 	4 Castors – 100 mm, all with locking devices 	Wheel base extension Length = 10 cm, inserts at back
Price / piece	Quantity	Upcharge / set
<input type="checkbox"/> 30 02 021 135 €	_____	<input type="checkbox"/> 73 01 060 83 €
		Price / set
		<input type="checkbox"/> 73 01 028 151 €

Padding		Accessories	
Padded footplate cover – covered with black flexi cover, height: 3 cm (not possible in combination with foot straps) 	Table upholstery – covered with black flexi cover, height: 1 cm 	Harness assembly kit for the seat consisting of 2 brackets with clip buckle and 2 clip buckles (drilled)	Harness assembly kit for the back consisting of 2 threaded plates with clip buckles and 2 clip buckles (drilled)
Price / piece	Price / piece	Upcharge / set	Upcharge / set
<input type="checkbox"/> 73 02 038 99 €	<input type="checkbox"/> 73 02 054 112 €	<input type="checkbox"/> 20 mm (73 00 025) 39 € <input type="checkbox"/> 25 mm (73 01 025) 39 €	<input type="checkbox"/> 20 mm (73 00 026) 39 € <input type="checkbox"/> 25 mm (73 01 026) 39 €

Harness

T-shape groin harness – made of elastic, breathable material, with two clips at front, straps sewn at back

	Size 1	Size 2
A	25 cm	28 cm
B	17 cm	20 cm
C	35 cm	38 cm
D	26 cm	28 cm
Strap width	2 cm	2.5 cm



	Price / piece	Colour
<input type="checkbox"/> Size 1 (73 01 033)	133 €	<input type="checkbox"/> Black (91 00 040)
<input type="checkbox"/> Size 2 (73 02 033)	133 €	<input type="checkbox"/> Light grey (91 00 049)

Groin harness (standard) – made of elastic, breathable material, with two clips at front, straps sewn at back

	Size 1	Size 2	Size 3
A	24 cm	29 cm	33 cm
B	14 cm	17 cm	22 cm
C	35 cm	43 cm	49 cm
Strap width	2 cm	2.5 cm	2.5 cm

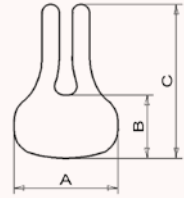

	Price / piece	Colour
<input type="checkbox"/> Size 1 (73 01 034)	133 €	<input type="checkbox"/> Black (91 00 040)
<input type="checkbox"/> Size 2 (73 02 034)	133 €	<input type="checkbox"/> Light grey (91 00 049)
<input type="checkbox"/> Size 3 (73 03 034)	133 €	

Harness

Pelvic harness – with pad and adjustable clip on both sides

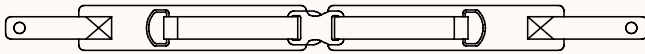

	Size 1	Size 2
Pad width	4 cm	5 cm
Pad length per side	18 cm	28 cm
Strap length per side	30 cm	40 cm
Strap width	2,5 cm	2.5 cm

	Price / piece	Colour
<input type="checkbox"/> Size 1 (73 01 035)	80 €	<input type="checkbox"/> Black (91 00 040)
<input type="checkbox"/> Size 2 (73 02 035)	80 €	<input type="checkbox"/> Light grey (91 00 049)

4-point pelvic harness – with pad and adjustable clip on both sides

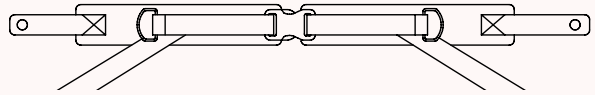

	Size 1	Size 2
Pad width	4 cm	5 cm
Pad length per side	18 cm	28 cm
Strap length per side	30 cm	40 cm
Strap width	2.5 cm	2.5 cm

	Price / piece	Colour
<input type="checkbox"/> Size 1 (73 01 036)	139 €	<input type="checkbox"/> Black (91 00 040)
<input type="checkbox"/> Size 2 (73 02 036)	139 €	<input type="checkbox"/> Light grey (91 00 049)

Harness

Chest-shoulder strap – made of elastic, breathable material, three straps with clips, sewn strap to the left shoulder

	Size 1	Size 2	Size 3
A	13 cm	18 cm	18 cm
B	19 cm	20 cm	21 cm
C	15 cm	19 cm	28 cm
D	5 cm	5 cm	5 cm
E	28 cm	34 cm	44 cm
Strap width	2 cm	2.5 cm	2.5 cm

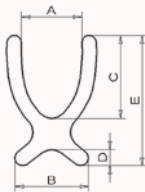

	Price / piece	Colour
<input type="checkbox"/> Size 1 (73 01 032)	160 €	<input type="checkbox"/> Black (91 00 040)
<input type="checkbox"/> Size 2 (73 02 032)	160 €	<input type="checkbox"/> Light grey (91 00 049)
<input type="checkbox"/> Size 3 (73 03 032)	160 €	

Positioning jacket – made of elastic, breathable and moisture repellent material, with two clips at front, straps sewn at back

	Size 1	Size 2
A	11 cm	18 cm
B	21 cm	22 cm
C	12 cm	15 cm
D	3.5 cm	3.5 cm
E	28 cm	34 cm
Strap width	2 cm	2.5 cm

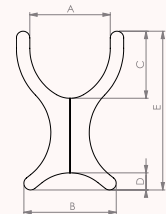

	Price / piece	Colour
<input type="checkbox"/> Size 1 (73 01 056)	185 €	<input type="checkbox"/> Black (91 00 040)
<input type="checkbox"/> Size 2 (73 02 056)	185 €	<input type="checkbox"/> Light grey (91 00 049)

Harness

Ankle cuffs – with velcro fastener and idler pulley colour: black (not possible in combination with padded cover for footplate)

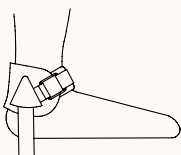

	Ankle circumference	Strap width
Size 1	12 – 19 cm	25 mm
Size 2	15 – 23 cm	25 mm
Size 3	19 – 27 cm	40 mm

	Price / pair
<input type="checkbox"/> Size 1 (73 01 061)	190 €
<input type="checkbox"/> Size 2 (73 02 061)	190 €
<input type="checkbox"/> Size 3 (73 03 061)	190 €

Foot positioner – with straps, incl. velcro fastener (not possible in combination with padded cover for footplate)

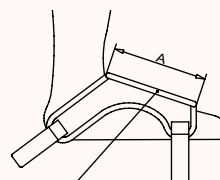

Velcro strip to open

	A	Strap width
Size 1	8 cm	2 cm
Size 2	10 cm	2 cm
Size 3	13 cm	2.5 cm

	Price / pair
<input type="checkbox"/> Size 1 (73 01 062)	176 €
<input type="checkbox"/> Size 2 (73 02 062)	176 €
<input type="checkbox"/> Size 3 (73 03 062)	176 €

madita maxi.

Invoice address:**Dispatch address:**
 See invoice address

 Order
 Cost estimate

Customer No.: _____

Orderer: _____

Date: _____

Signature: _____

Commission:**The solid therapy chair.**

- Seat pad with anatomic shaping and cover
- The seat height is adjustable using a crank, and the angular adjustment can be operated through two gas pressure springs à 200N via a foot pedal
- Incl. push handle and armrests with adjustable height, width and angle with extra side support
- Incl. 4 dual castors (100 mm), 2 with locking devices

HMV-No.: 26.11.05.0021
Dimensions - basic model

A	Seat depth	36 - 47 cm
B	Seat width	34 - 44 cm
C*	Height short back	40 cm
C*	Height long back	48 cm
C**	Height short back	48 cm
C**	Height long back	56 cm
E	Seat height	48 - 60 cm
F	Lower leg length	18 - 45 cm
G	Total width	64 cm
H	Length of base frame	80 cm
	Tilt-in-space	(-)5° - 30°
	Back angle	(-)5° - 25°
	Max. load	120 kg
	Weight	26 kg

* made of 3 mm aluminium sheet metal | ** made of 4 mm aluminium sheet metal

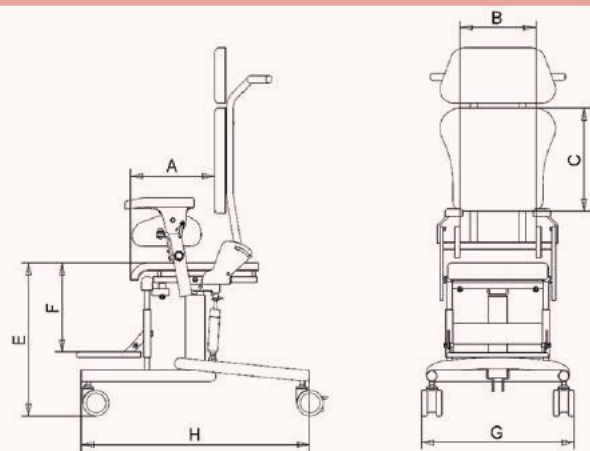
Basic model
madita maxi.

Price / piece

 30 03 000 2.275 €

Frame colours
 Anthracit metallic

 Tellegry 4 (white grey)

Price

Price

 92 00 014

incl.

 92 00 011

incl.

Covers		Coated covers		Minor position
	Petrol/Dark grey (No. 112 + 92)		Black/Dark grey (No. 105 + 92)	
	Price		Price	
	<input type="checkbox"/> 9100235 incl.		<input type="checkbox"/> 9100236 incl.	Upcharge
			225 €	Price reduction
				<input type="checkbox"/> 3003001 Net -104 €

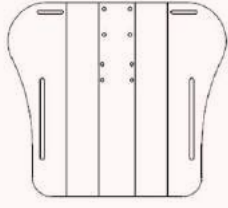
Configuration options - back				
	Standard-Back – incl. individually adjustable back pad, anatomic shape, back angle adjustment with mechanical locking option		Maxi back made of 4 mm aluminium sheet metal incl. individually adjustable back pad, anatomic shape, back angle adjustment with mechanical locking option	
	Short back	40cm	Short back	48cm
	Long back	48cm	Long back	56cm
		Price / piece		Price / piece
	<input type="checkbox"/> short (30 02 002)	207 €	<input type="checkbox"/> short (30 03 002)	240 €
	<input type="checkbox"/> long (30 02 003)	207 €	<input type="checkbox"/> long (30 03 003)	240 €

Headrests			
	Headrest (standard) padded, height adjustable		Headrest (lateral guide) padded, height and angle adjustment
	Price / piece		Price / piece
<input type="checkbox"/> 30 03 004	252 €	<input type="checkbox"/> 30 02 011	336 €
			Headrest (shell-shaped) padded, height and angle adjustment
			Price / piece
		<input type="checkbox"/> 30 03 012	354 €

Accessories			
	Reinforced lateral pads – padded		Thigh guides – padded and angle adjustable
	Price / pair		Price / pair
<input type="checkbox"/> Chest width 32 – 38 cm (30 03 006)	126 €	<input type="checkbox"/> Standard 37 cm (30 03 021)	268 €
<input type="checkbox"/> Chest width 38 – 44 cm (30 03 106)	126 €	<input type="checkbox"/> Long 46 cm (30 03 022)	268 €
			Knee abduction wedge pluggable and padded
			Price / piece
		<input type="checkbox"/> 30 02 008	165 €

Accessories			
	Central parking brake for rear castors incl. 4 dual castors (100 mm), operated by using the parking lever which is mounted to the seat system		Therapy tray – made of wood with edge, pluggable, folding and removable
	Price / set		Price / piece
<input type="checkbox"/> Parking lever mounted left (30 03 051)	391 €	<input type="checkbox"/> 30 03 023	245 €
<input type="checkbox"/> Parking lever mounted right (30 03 551)	391 €		
<input type="checkbox"/> Parking lever mounted left; castors front with brakes (30 03 151)	422 €		
<input type="checkbox"/> Parking lever mounted right; castors front with brakes (30 03 651)	422 €		
			Incontinence coating in the seat area
			Upcharge
		<input type="checkbox"/> 30 00 001	176 €

Accessories		Footplate	
	Wheel base extension insertable, inserts at rear, length = 10 cm (not possible together with central parking brake)		Wooden footplate – height and foot angle adjustable, also folding
	Price / set		Price / piece
<input type="checkbox"/> 30 03 024	151 €	<input type="checkbox"/> 30 03 015	391 €
			Plug-on footplate height approx. 8 cm above the floor
			Price / piece
		<input type="checkbox"/> 30 03 016	317 €

Harness

The **madita maxi.**-harness is assembled with the harness assembly sets (see below). Further fixing aids and configuration options can be found from page 152. If a colour is not selected, we will use black as the standard colour for your order.

Harness

Chest-shoulder strap – made of elastic, breathable and moisture repellent material, three straps with clips, sewn strap to the left shoulder

	Size 3	Size 4
A	18 cm	20 cm
B	21 cm	22 cm
C	28 cm	30 cm
D	5 cm	6 cm
E	44 cm	52 cm
Strap width	2.5 cm	2.5 cm

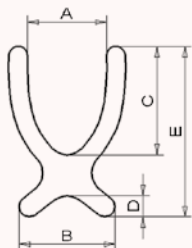

Groin harness (standard) – made of elastic, breathable and moisture repellent material, with two clips at front, straps sewn at back

	Size 4
A	36 cm
B	26 cm
C	55 cm
Strap width	2.5 cm

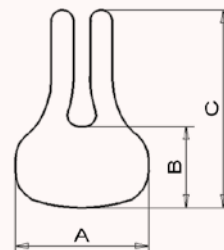

	Price / piece	Colour
<input type="checkbox"/> Size 3 (30 03 055)	160 €	<input type="checkbox"/> Black (91 00 040)
<input type="checkbox"/> Size 4 (30 04 055)	160 €	<input type="checkbox"/> Light grey (91 00 049)

	Price / piece	Colour
<input type="checkbox"/> Size 4 (30 04 058)	133 €	<input type="checkbox"/> Black (91 00 040)
		<input type="checkbox"/> Light grey (91 00 049)

Harness

Pelvic harness – with pad and adjustable clip on both sides



	Size 2	Size 3
Pad width	5 cm	6 cm
Pad length per side	28 cm	30 cm
Strap length per side	40 cm	40 cm
Strap width	2.5 cm	2.5 cm

	Price / piece	Colour
<input type="checkbox"/> Size 2 (30 02 059)	80 €	<input type="checkbox"/> Black (91 00 040)
<input type="checkbox"/> Size 3 (30 03 059)	80 €	<input type="checkbox"/> Light grey (91 00 049)

4-point pelvic harness – with pad and adjustable clip on both sides

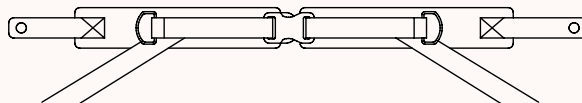

	Size 2	Size 3
Pad width	5 cm	6 cm
Pad length per side	28 cm	30 cm
Strap length per side	40 cm	40 cm
Strap width	2.5 cm	2.5 cm

	Price / piece	Colour
<input type="checkbox"/> Size 2 (30 02 060)	139 €	<input type="checkbox"/> Black (91 00 040)
<input type="checkbox"/> Size 3 (30 03 060)	139 €	<input type="checkbox"/> Light grey (91 00 049)

Harness assembly kit

Harness assembly kit for the seat – consisting of 2 brackets with clip buckle and 2 clip buckles (drilled)

	Upcharge / set
<input type="checkbox"/> 25 mm (30 03 070)	39 €
<input type="checkbox"/> 40 mm (30 04 070)	39 €

Harness assembly kit for the back – consisting of 2 threaded plates with clip buckles and 2 clip buckles (drilled)

	Upcharge / set
<input type="checkbox"/> 25 mm (30 03 071)	39 €
<input type="checkbox"/> 40 mm (30 04 071)	39 €

Fabric collection.

for our seat units **madita.**, **madita-fun.** & **sofie.**



Dark grey/Pink-Telemagenta
(No. 92 + 114)



Dark grey/Azur
(No. 92 + 110)



Dark grey/Deep orange
(No. 92 + 107)



Dark grey/Light blue
(No. 92 + 106)



Black/Dark grey
(No. 105 + 92)



Jeans
(No. 116)



Flexi Black/Light grey
(No. 43 + 50)



Flexi Black/Red
(No. 43 + 45)



Flexi Blue
(No. 44)

The fabric combinations shown for our covers can be selected directly from our aids **madita.** (page 8), **madita-fun.** (page 14) und **sofie.** (page 32).

sofie.

Invoice address:

Dispatch address:

See invoice address

Order

Cost estimate

Customer No.: _____

Orderer: _____

Date: _____

Signature: _____

Commission:

The individual seat unit that grows with the child.

- Incl. armrests with adjustable height, width and angle
- Incl. standard seat pad with cover
- Adjustment options: back angle, back height, seat depth, seat width
- Adaptable to all standard exterior and interior chassis

HMV-No.: 26.11.04.0xxx



Presettings

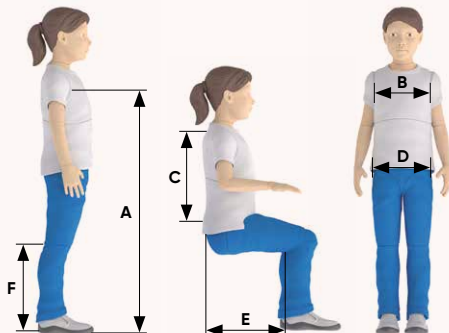

Presettings on the therapy chair at Schuchmann.
Please provide us with the following body measurements:

A Axilla height _____

B Chest width _____

C Back height _____

D Pelvic width _____

E Seat depth _____

F Lower leg length _____

17 00080

Price

incl.

Dimensions - basic model						
		Size 0	Size 1	Size 1 b	Size 2	
A	Seat depth*	15 - 25 cm	21 - 30 cm	26 - 36 cm	30 - 42 cm	
B	Seat width	16 - 26 cm	20 - 30 cm	20 - 30 cm	28 - 38 cm	
C	Back height (short back)	35 - 43 cm	35 - 43 cm	42 - 52 cm	42 - 52 cm	
C	Back height (long back)	42 - 52 cm	42 - 52 cm	53 - 63 cm	53 - 63 cm	
	Back angle	(-)5° - 25°	(-)5° - 25°	(-)5° - 25°	(-)5° - 25°	
	Max. load	30 kg	30 kg	45 kg	50 kg	
	Weight	9 kg	10 kg	10 kg	12 kg	
	Recommended for subframes	freddy. Size 0	freddy. Size 0	freddy. size 1 + anti tip bar, franka. size 2, fridolin 1+2. size 2	freddy. size 2 + anti tip bar, franka. size 2, fridolin 1+2. size 2	

* reduced by 1 cm in combination with adjustable pelvic guide

Basic model			
sofie. size 0	sofie. size 1	sofie. size 1 b	sofie. size 2
Price / piece	Price / piece	Price / piece	Price / piece
□ 17 00 100 1.309 €	□ 17 01 100 1.309 €	□ 17 01 200 1.380 €	□ 17 02 100 1.461 €



Frame colours				
Lasurit blue metallic	White aluminium (silver)	Dormant Red	Pure white	Anthrazit metallic
Price	Price	Price	Price	Price
□ 92 00 010 incl.	□ 92 00 002 incl.	□ 92 00 003 incl.	□ 92 00 100 incl.	□ 92 00 014 incl.





Covers				
Dark grey/ Pink-Telemagenta (No. 92 + 114) 	new Dark grey/ Azur (No. 92 + 110) 	Dark grey/ Deep orange (No. 92 + 107) 	Dark grey/ Light blue (No. 92 + 106) 	
Price	Price	Price	Price	
□ 91 00 222 incl.	□ 91 00 225 incl.	□ 91 00 213 incl.	□ 91 00 214 incl.	

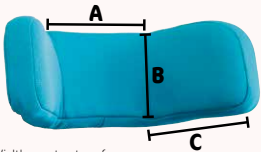

Covers	Name embroidery	Minor position
Black/ Dark grey (No. 105 + 92) 	Jeans (No. 116) 	Name embroidery on the back pad – please fill out the form on page 15! An embroidery of Flexi fabrics is not possible. 
Price	Price	Without seat and back upholstery and cover – for the installation of custom cushions.
□ 91 00 205 incl.	□ 91 00 116 incl.	Price reduction □ 60 00 062 Net -104 €

Coated covers		
Flexi Black/ Light grey (No. 43 + 50) 	Flexi Black/ Red (No. 43 + 45) 	Flexi Blue (No. 44) 
Upcharge	Upcharge	Upcharge
□ 91 00 226 225 €	□ 91 00 227 225 €	□ 91 00 044 225 €

Headrests			
Headrest (standard) padded, incl. cover, height and angle adjustable 	Headrest (shell-shaped) padded, incl. cover, height and angle adjustable 	Headrest (lateral guide) padded, incl. cover, height and angle adjustable 	
Price / piece		Price / piece	
<input type="checkbox"/> for size 0 (1700013) 228 € <input type="checkbox"/> for size 1 (1701013) 228 € <input type="checkbox"/> for size 2 (1702013) 228 €	<input type="checkbox"/> for size 0+1 (1701015) 323 € <input type="checkbox"/> for size 2 (1702015) 323 €	<input type="checkbox"/> for size 0+1 (1701014) 307 € <input type="checkbox"/> for size 2 (1702014) 307 €	

Headrests																			
Headrest (lateral guide, angle adjustable) – padded, incl. cover, height, depth and angle adjustable, side guides are each angle adjustable 		<table border="1"> <thead> <tr> <th></th> <th>A</th> <th>B</th> <th>C</th> </tr> </thead> <tbody> <tr> <td>Size 1</td> <td>13.5 cm</td> <td>10.5 cm</td> <td>10 cm</td> </tr> <tr> <td>Size 2</td> <td>15 cm</td> <td>10.5 cm</td> <td>13,5 cm</td> </tr> <tr> <td>Size 3</td> <td>17 cm</td> <td>12.5 cm</td> <td>16.5 cm</td> </tr> </tbody> </table>		A	B	C	Size 1	13.5 cm	10.5 cm	10 cm	Size 2	15 cm	10.5 cm	13,5 cm	Size 3	17 cm	12.5 cm	16.5 cm	Universal adapter for tailored headrests 15x15 mm
	A	B	C																
Size 1	13.5 cm	10.5 cm	10 cm																
Size 2	15 cm	10.5 cm	13,5 cm																
Size 3	17 cm	12.5 cm	16.5 cm																
A = Width contact surface B = Height headrest C = Width lateral guide		Price / piece	Price / piece																
<input type="checkbox"/> Size 1 (1701050) 528 € <input type="checkbox"/> Size 2 (1702050) 528 € <input type="checkbox"/> Size 3 (1703050) 528 €		<input type="checkbox"/> for size 0+1 (1701016) 76 € <input type="checkbox"/> for size 2 (1702016) 76 €																	

Configuration options - back (Standard design or with integrated upper arm guide)				
Back – incl. pad and cover	for size 0	for size 1	for size 1b	for size 2
Short back:	35 - 43 cm	35 - 43 cm	42 - 52 cm	42 - 52 cm
Long back:	42 - 52 cm	42 - 52 cm	53 - 63 cm	53 - 63 cm
	Price / piece	Price / piece	Price / piece	Price / piece
 Short standard design:	<input type="checkbox"/> 1700003 166 € <input type="checkbox"/> 1700004 166 €	<input type="checkbox"/> 1701003 166 € <input type="checkbox"/> 1701004 166 €	<input type="checkbox"/> 1701103 166 € <input type="checkbox"/> 1701104 166 €	<input type="checkbox"/> 1702003 187 € <input type="checkbox"/> 1702004 187 €
 Short with upper arm guide:	<input type="checkbox"/> 1700005 264 € <input type="checkbox"/> 1700006 264 €	<input type="checkbox"/> 1701005 264 € <input type="checkbox"/> 1701006 264 €	<input type="checkbox"/> 1701105 264 € <input type="checkbox"/> 1701106 264 €	<input type="checkbox"/> 1702005 282 € <input type="checkbox"/> 1702006 282 €
 Long standard design:	<input type="checkbox"/> 1700003 166 € <input type="checkbox"/> 1700004 166 €	<input type="checkbox"/> 1701003 166 € <input type="checkbox"/> 1701004 166 €	<input type="checkbox"/> 1701103 166 € <input type="checkbox"/> 1701104 166 €	<input type="checkbox"/> 1702003 187 € <input type="checkbox"/> 1702004 187 €
 Long with upper arm guide:	<input type="checkbox"/> 1700005 264 € <input type="checkbox"/> 1700006 264 €	<input type="checkbox"/> 1701005 264 € <input type="checkbox"/> 1701006 264 €	<input type="checkbox"/> 1701105 264 € <input type="checkbox"/> 1701106 264 €	<input type="checkbox"/> 1702005 282 € <input type="checkbox"/> 1702006 282 €

Configuration options - back		
Back unit – fixed (standard configuration = without push handles, if nothing else stated) 	Back unit – removable 	Adjustable limitation of the back angle – to determine the individual max. back angle
Price / piece	Price / piece	Price / set
<input type="checkbox"/> for size 0+1 with push handles (1701009) incl. <input type="checkbox"/> for size 2 with push handles (1702009) incl. <input type="checkbox"/> for size 0+1 without push handles (1701010) incl. <input type="checkbox"/> for size 2 without push handles (1702010) incl. <input type="checkbox"/> for size 0+1 with push bar (1701007) incl.	<input type="checkbox"/> for size 0+1 with push handles (1701011) 333 € <input type="checkbox"/> for size 2 with push handles (1702011) 333 € <input type="checkbox"/> for size 0+1 without push handles (1701012) 333 € <input type="checkbox"/> for size 2 without push handles (1702012) 333 €	<input type="checkbox"/> 1700046 56 €

Configuration possibilities - lateral pads (Step 1: Select the bracket)				
Chest width – mounted on sofie. size 0	Chest width – mounted on sofie. size 1 + 1b	Chest width – mounted on sofie. size 2	Bracket	Upcharge / pair
13 - 20 cm	16 - 23 cm	26 - 32 cm	<input type="checkbox"/> Fixed (1700017) incl. <input type="checkbox"/> Flip away (1700018) 233 €	
20 - 27 cm	23 - 30 cm	32 - 38 cm	<input type="checkbox"/> Fixed (1701017) incl. <input type="checkbox"/> Flip away (1701018) 233 €	
___ - ___ cm	___ - ___ cm	___ - ___ cm	<input type="checkbox"/> Fixed and tailored (1709017) 63 € <input type="checkbox"/> Flip away and tailored (1709018) 296 €	

(Step 2: Select the lateral pads)

	Lateral pads size 0 padded, incl. cover (standard configuration for sofie , size 0, if nothing else stated) Height: 7 cm Depth: 9 cm	Lateral pads size 1 padded, incl. cover (standard configuration for sofie , size 1, if nothing else stated) Height: 8 cm Depth: 13 cm	Lateral pads size 2 padded, incl. cover (standard configuration for sofie , size 2, if nothing else stated) Height: 11 cm Depth: 16 cm	Tailored lateral pads padded, incl. cover Height: ___ cm Depth: ___ cm
	Price / pair	Price / pair	Price / pair	Price / pair
	<input type="checkbox"/> 17 00 019 95 €	<input type="checkbox"/> 17 01 019 95 €	<input type="checkbox"/> 17 02 019 95 €	<input type="checkbox"/> 17 09 019 187 €



(Step 2: Select the lateral pads)

	Lateral pads size 0, long (trunk guidance) padded, incl. cover Height: 13 cm Depth: 7 cm	Lateral pads size 1, long (trunk guidance) padded, incl. cover Height: 15 cm Depth: 8 cm	Lateral pads size 2, long (trunk guidance) padded, incl. cover Height: 17 cm Depth: 9 cm	Tailored lateral pads, long (trunk guidance) padded, incl. cover Height: ___ cm Depth: ___ cm
	Lateral pads (long) with flip away bracket can be folded 20° to the side.			
	Price / pair	Price / pair	Price / pair	Price / pair
<input type="checkbox"/> 17 00 020 167 €	<input type="checkbox"/> 17 01 020 167 €	<input type="checkbox"/> 17 02 020 167 €	<input type="checkbox"/> 17 09 020 259 €	

Thigh guides

	Thigh guides for size 0 padded, incl. cover, adjustable angle, depth and width 10 cm = standard configuration for size 0	Thigh guides for sizes 1 + 1 b padded, incl. cover, adjustable angle, depth and width 12 cm = standard configuration for sizes 1 + 1 b	Thigh guides for size 2 padded, incl. cover, adjustable angle, depth and width 17 cm = standard configuration for size 2
	Price / pair	Price / pair	Price / pair
	<input type="checkbox"/> 10 cm (17 00 021) 172 € <input type="checkbox"/> 12 cm (17 00 022) 172 €	<input type="checkbox"/> 12 cm (17 01 021) 172 € <input type="checkbox"/> 17 cm (17 01 022) 172 €	<input type="checkbox"/> 17 cm (17 02 021) 177 € <input type="checkbox"/> 22 cm (17 02 022) 177 €

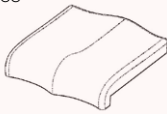
Seat option



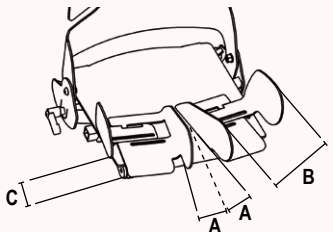

Standard seat pad – incl. cover (standard configuration, if nothing else stated) 	Seat pad – incl. cover with anatomi- c leg guidance 	Adjustable pelvic guidance – padded, incl. cover 	
Price / piece	Upcharge / piece	Price / piece	
<input type="checkbox"/> for size 0 (17 00 023) incl. <input type="checkbox"/> for size 1 (17 01 023) incl. <input type="checkbox"/> for size 1 b (17 01 123) incl. <input type="checkbox"/> for size 2 (17 02 023) incl.	<input type="checkbox"/> for size 0 (17 00 024) 195 € <input type="checkbox"/> for size 1 (17 01 024) 195 € <input type="checkbox"/> for size 1 b (17 01 124) 195 € <input type="checkbox"/> for size 2 (17 02 024) 195 €	<input type="checkbox"/> for size 0 – seat width A = 15 – 24 cm (17 00 026) 345 € <input type="checkbox"/> for size 1 + 1 b – seat width A = 18 – 28 cm (17 01 026) 345 € <input type="checkbox"/> for size 2 – seat width A = 26 – 36 cm (17 02 026) 365 €	

Seat option

Abductable leg guidance – with leg length compensation, padded, incl. cover (already includes thigh guides)				
	for size 0	for size 1+1b	for size 2	
A	0° – 20°	0° – 20°	0° – 20°	
B	7 – 10 cm	9 – 12 cm	10 – 14 cm	
C	3 cm	3 cm	3 cm	
	Price / piece			
<input type="checkbox"/> for size 0 (17 00 025)	467 €			
<input type="checkbox"/> for size 1 (17 01 025)	467 €			
<input type="checkbox"/> for size 1 b (17 01 125)	467 €			
<input type="checkbox"/> for size 2 (17 02 025)	487 €			
	A = Abduction angle B = Thigh width C = Leg length compensation			



Split footplates

Split footplates – individually adjustable, adjustable in height, width and angle, foldable, fixed to the seat unit, with non-slip surface and 4 slots (each) for attaching straps 	Split footplates with foot cups – individually adjustable, adjustable in height, width and angle, foldable, fixed to the seat unit 
Price / pair	Price / pair
<input type="checkbox"/> for size 0 (17 00 052) 411 € <input type="checkbox"/> for size 1 (17 01 052) 411 € <input type="checkbox"/> for size 1 b (17 01 152) 411 € <input type="checkbox"/> for size 2 (17 02 052) 411 €	<input type="checkbox"/> Size 0 (17 00 051) 411 € <input type="checkbox"/> Size 1 (17 01 051) 411 € <input type="checkbox"/> Size 2 (17 02 051) 411 €

Footplate			Accessories						
Footplate – height and knee angle adjustable, foldable, fixed to the seat unit, with non-slip surface and 8 slots for attaching straps			Knee abduction wedge pluggable and padded, incl. cover			Therapy tray – made of wood with edge		Therapy tray transparent, with edge	
Price / piece		Price / piece		Price / piece		Price / piece		Price / piece	
<input type="checkbox"/> for size 0 (17 00 102)	305 €	<input type="checkbox"/> Size 0 (17 00 108)	202 €	<input type="checkbox"/> for size 0 (17 00 027)	223 €	<input type="checkbox"/> for size 0 (17 00 028)	307 €		
<input type="checkbox"/> for size 1 (17 01 102)	305 €	<input type="checkbox"/> Size 1 (17 01 108)	202 €	<input type="checkbox"/> for size 1 (17 01 027)	223 €	<input type="checkbox"/> for size 1 (17 01 028)	307 €		
<input type="checkbox"/> for size 1b (17 01 112)	305 €	<input type="checkbox"/> Size 2 (17 02 108)	202 €	<input type="checkbox"/> for size 2 (17 02 027)	223 €	<input type="checkbox"/> for size 2 (17 02 028)	307 €		
<input type="checkbox"/> for size 2 (17 02 102)	305 €								

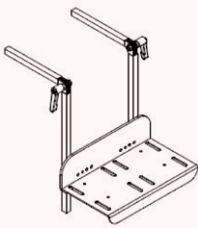
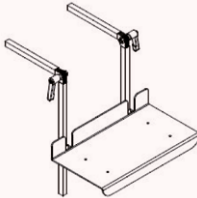
Adapter					
Trapezoidal adapter lower part		Trapezoidal adapter top part		Assembly of one of the adjacent adapters for seat depth	
to suit		to suit			
Size 0	sofie. size 0	Size 0	sofie. size 0		
Size 1	sofie. size 0-2	Size 1	sofie. size 0-2		
Price / piece		Price / piece			
<input type="checkbox"/> Size 0 (17 00 085)	179 €	<input type="checkbox"/> Size 0 (17 00 086)	117 €	<input type="checkbox"/> Size 0: 15 – 21cm (17 00 030)	
<input type="checkbox"/> Size 1 (17 01 085)	179 €	<input type="checkbox"/> Size 1 (17 01 086)	117 €	<input type="checkbox"/> Size 0: 19 – 25cm (17 00 031)	
				<input type="checkbox"/> Size 1: 21 – 26cm (17 01 030)	
				<input type="checkbox"/> Size 1: 25 – 30cm (17 01 031)	
				<input type="checkbox"/> Size 2: 30 – 36cm (17 02 030)	
				<input type="checkbox"/> Size 2: 37 – 42cm (17 02 031)	

Footplate for subframes			Accessories		
Aluminium Footplate – with heel edge, height and knee angle adjustment			Aluminium Footplate – with heel edge, height, knee and foot angle adjustment, also folding		
Width		Width			
Size 1	26 cm	Size 1	28 cm		
Size 2	30 cm	Size 2	34 cm		
Size 3	36 cm	Size 3	40 cm		
Price / piece		Price / piece		Upcharge / set	
<input type="checkbox"/> Size 1 (17 01 087)	220 €	<input type="checkbox"/> Size 1 (17 01 088)	290 €	<input type="checkbox"/> 17 00 089 100 €	
<input type="checkbox"/> Size 2 (17 02 087)	220 €	<input type="checkbox"/> Size 2 (17 02 088)	290 €		
<input type="checkbox"/> Size 3 (17 03 087)	220 €	<input type="checkbox"/> Size 3 (17 03 088)	290 €		

Accessories			
Incontinence coating – in the seat area		Harness assembly kit for the seat consisting of 2 brackets with clip buckle and 2 clip buckles (drilled)	
			
Price / piece		Upcharge / set	
<input type="checkbox"/> 17 00 029	176 €	<input type="checkbox"/> 20 mm (17 00 033)	39 €
		<input type="checkbox"/> 25 mm (17 01 033)	39 €
		<input type="checkbox"/> 20 mm (17 00 034)	39 €
		<input type="checkbox"/> 25 mm (17 01 034)	39 €

Polster			
Padded footplate cover – covered with black flexi cover, height: 3 cm (not possible in combination with foot straps)		Padded cover for split footplate – covered with black flexi cover, height: 3 cm (not possible in combination with foot straps)	
			
Price / piece		Price / pair	
<input type="checkbox"/> for size 0 (17 00 035)	99 €	<input type="checkbox"/> for size 0 (17 00 036)	127 €
<input type="checkbox"/> for size 1 (17 01 035)	99 €	<input type="checkbox"/> for size 1 (17 01 036)	127 €
<input type="checkbox"/> for size 2 (17 02 035)	99 €	<input type="checkbox"/> for size 2 (17 02 036)	127 €
		Table upholstery – covered with black flexi cover, height: 1 cm	
			
		Price / piece	
		<input type="checkbox"/> for size 0 (17 00 037)	112 €
		<input type="checkbox"/> for size 1 (17 01 037)	112 €
		<input type="checkbox"/> for size 2 (17 02 037)	112 €

Harness

The **sofie.**-harness is assembled with the harness assembly sets (see page 36). Further fixing aids and configuration options can be found starting on page 152. If a colour is not selected, we will use black as the standard colour for your order.

Harness

Chest-shoulder strap – made of elastic, breathable and moisture repellent material, three straps with clips, sewn strap to the left shoulder

	Size 0	Size 1	Size 2	Size 3
A	13cm	13cm	18cm	18cm
B	17.5cm	19cm	20cm	21cm
C	15cm	15cm	19cm	28cm
D	3.5cm	5cm	5cm	5cm
E	25.5cm	28cm	34cm	44cm
Strap width	2cm	2cm	2.5cm	2.5cm

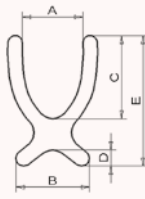

Positioning jacket – with zipper, made of elastic, breathable material, shoulder straps sewn at back, pelvis straps with clips

	Size 0	Size 1	Size 2
A	11cm	11cm	18cm
B	21cm	21cm	22cm
C	12cm	12cm	15cm
D	2.5cm	3.5cm	3.5cm
E	25.5cm	28cm	34cm
Strap width	2cm	2cm	2.5cm

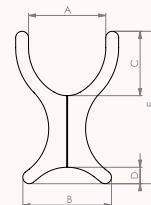

	Price / piece	Colour
<input type="checkbox"/> Size 0 (1700038)	160 €	<input type="checkbox"/> Black (9100040)
<input type="checkbox"/> Size 1 (1701038)	160 €	<input type="checkbox"/> Light grey (9100049)
<input type="checkbox"/> Size 2 (1702038)	160 €	
<input type="checkbox"/> Size 3 (1703038)	160 €	

	Price / piece	Colour
<input type="checkbox"/> Size 0 (1700039)	185 €	<input type="checkbox"/> Black (9100040)
<input type="checkbox"/> Size 1 (1701039)	185 €	<input type="checkbox"/> Light grey (9100049)
<input type="checkbox"/> Size 2 (1702039)	185 €	

Harness

T-shape groin harness – made of elastic, breathable and moisture repellent material, with two clips at front, straps sewn at back

	Size 0	Size 1	Size 2
A	23cm	25cm	28cm
B	15cm	17cm	20cm
C	33cm	35cm	38cm
D	24cm	26cm	28cm
Strap width	2cm	2cm	2.5cm

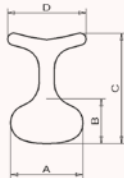

Groin harness (standard) – made of elastic, breathable and moisture repellent material, with two clips at front, straps sewn at back

	Size 1	Size 2	Size 3
A	24cm	29cm	33cm
B	14cm	17cm	22cm
C	35cm	43cm	49cm
Strap width	2cm	2.5cm	2.5cm

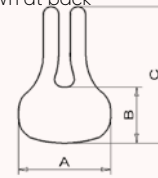

	Price / piece	Colour
<input type="checkbox"/> Size 0 (1700040)	133 €	<input type="checkbox"/> Black (9100040)
<input type="checkbox"/> Size 1 (1701040)	133 €	<input type="checkbox"/> Light grey (9100049)
<input type="checkbox"/> Size 2 (1702040)	133 €	

	Price / piece	Colour
<input type="checkbox"/> Size 1 (1701041)	133 €	<input type="checkbox"/> Black (9100040)
<input type="checkbox"/> Size 2 (1702041)	133 €	<input type="checkbox"/> Light grey (9100049)
<input type="checkbox"/> Size 3 (1703041)	133 €	

Harness

Pelvic harness – with pad and adjustable clip on both sides



	Size 0	Size 1	Size 2
Pad width	4cm	4cm	5cm
Pad length per side	16cm	18cm	28cm
Strap length per side	30cm	30cm	40cm
Strap width	2cm	2.5cm	2.5cm

4-point pelvic harness – with pad and adjustable clip on both sides



	Size 0	Size 1	Size 2
Pad width	4cm	4cm	5cm
Pad length per side	16cm	18cm	28cm
Strap length per side	30cm	30cm	40cm
Strap width	2cm	2.5cm	2.5cm

	Price / piece	Colour
<input type="checkbox"/> Size 0 (1700042)	80 €	<input type="checkbox"/> Black (9100040)
<input type="checkbox"/> Size 1 (1701042)	80 €	<input type="checkbox"/> Light grey (9100049)
<input type="checkbox"/> Size 2 (1702042)	80 €	

	Price / piece	Colour
<input type="checkbox"/> Size 0 (1700043)	139 €	<input type="checkbox"/> Black (9100040)
<input type="checkbox"/> Size 1 (1701043)	139 €	<input type="checkbox"/> Light grey (9100049)
<input type="checkbox"/> Size 2 (1702043)	139 €	

Harness

Ankle cuffs – with velcro fastener and idler pulley colour: black (not possible in combination with padded cover for footplate/split footplate)

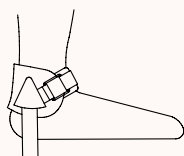

	Ankle circumference	Strap width
Size 1	12 – 19cm	25mm
Size 2	15 – 23cm	25mm
Size 3	19 – 27cm	40mm

	Price / pair
<input type="checkbox"/> Size 1 (1701044)	190 €
<input type="checkbox"/> Size 2 (1702044)	190 €
<input type="checkbox"/> Size 3 (1703044)	190 €

Foot positioner – with straps, incl. velcro fastener (not possible in combination with padded cover for footplate/split footplate)

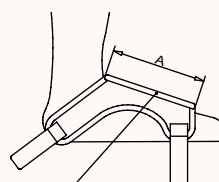

Velcro strip to open

	A	Strap width
Size 1	8cm	2cm
Size 2	10cm	2cm
Size 3	13cm	2.5cm

	Price / pair
<input type="checkbox"/> Size 1 (1701045)	176 €
<input type="checkbox"/> Size 2 (1702045)	176 €
<input type="checkbox"/> Size 3 (1703045)	176 €

activity chair.

Invoice address:
Dispatch address:
 See invoice address

 Order
 Cost estimate

Customer No.: _____

Orderer: _____

Date: _____

Signature: _____

Commission:
The dynamic therapy chair.

- Seat and back unit incl. pad
- Back angle adjustment via gas pressure spring from (-)5° to 20°
- Incl. 2-point pelvic harness
- Basic frame with height adjustable feet
- Tilt-in-space adjustment via gas pressure spring (-)15° to 15°
- Frame colour: Effect black

HMV-No.: 26.11.05.0xxx

Dimensions - basic model



	Size 0	Size 1	Size 2
Seat depth	20 - 30 cm	28 - 41 cm	38 - 51 cm
Seat width	30 cm	36 cm	43 cm
Seat width (with hip support pads)	18 - 23 cm	22 - 29 cm	28 - 36 cm
Chest width	14 - 29 cm	17 - 30 cm	24 - 36 cm
Back height	32 - 39 cm	39 - 48 cm	48 - 61 cm
Height headrest - seat	37 - 53 cm	44 - 62 cm	50 - 75 cm
Height from armrest to seat	13 - 19 cm	18 - 27 cm	18 - 27 cm
Lower leg length	23 - 30 cm	30 - 41 cm	38 - 51 cm
Seat height above floor	with short / long feet	24 - 32 cm / 47 - 55 cm	32 - 42 cm / 48 - 58 cm
	with short / long feet and dual castors	34 - 42 cm / 47 - 55 cm	41 - 51 cm / 48 - 58 cm
Frame width	with short / long feet	53 / 58 cm	59 / 62 cm
	with short / long feet and dual castors	57 / 60 cm	62 / 65 cm
Tilt-in-space	(-)15° - 15°	(-)15° - 15°	(-)15° - 15°
Back angle	(-)5° - 20°	(-)5° - 20°	(-)5° - 20°
Max. load	34 kg	68 kg	113 kg

Basic model			
	activity chair. size 0	activity chair. size 1	activity chair. size 2
Price / piece		Price / piece	
<input type="checkbox"/> 72 00 000 (R821+R823) 1.467 €		<input type="checkbox"/> 72 01 000 (R841+R843) 1.467 €	
<input type="checkbox"/> 72 02 000 (R861+R873) 1.613 €			

Basic model			
	activity chair. size 0 with dynamic seat edge and dynamic back	activity chair. size 1 with dynamic seat edge and dynamic back	activity chair. size 2 with dynamic seat edge and dynamic back
Price / piece		Price / piece	
<input type="checkbox"/> 72 00 100 (R822+R824) 1.868 €		<input type="checkbox"/> 72 01 100 (R842+R844) 1.868 €	
<input type="checkbox"/> 72 02 100 (R862+R874) 2.034 €			

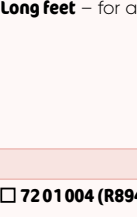
Pad colour			
	Blue		Red
Price		Price	
<input type="checkbox"/> for size 0 (72 05 201) (R816) incl.		<input type="checkbox"/> for size 0 (72 05 301) (R817) incl.	
<input type="checkbox"/> for size 1 (72 00 201) (R836) incl.		<input type="checkbox"/> for size 1 (72 00 301) (R837) incl.	
<input type="checkbox"/> for size 2 (72 02 201) (R876) incl.		<input type="checkbox"/> for size 2 (72 02 301) (R877) incl.	

Feet			
	Short feet – (standard configuration, if nothing else stated)		Long feet – for all sizes
Price / set		Price / set	
<input type="checkbox"/> for size 0 (72 04 004) (R803) incl.		<input type="checkbox"/> 72 01 004 (R894) incl.	
<input type="checkbox"/> for size 1 (72 00 004) (R893) incl.			
<input type="checkbox"/> for size 2 (72 05 004) (R808) incl.			

Feet			
	4 dual castors (75 mm) short version, with brakes, 1 x with direction lock		4 dual castors (75 mm) long version, with brakes, 1 x with direction lock, for all sizes
Upcharge / set		Upcharge / set	
<input type="checkbox"/> for size 0 (72 06 004) (R805) 323 €		<input type="checkbox"/> 72 03 004 (R896) 323 €	
<input type="checkbox"/> for size 1+2 (72 02 004) (R895) 323 €			

Accessories		
<p>Headrest (standard) – depth, angle and height adjustable</p> 	<p>Headrest (shell-shaped) – depth, angle and height adjustable</p> 	<p>Headrest (lateral guide) – depth, angle and height adjustable, wing pads can be adjusted from almost flat to 90°</p> 
Price / piece	Price / piece	Price / piece
<input type="checkbox"/> 72 00 010 (R898) 289 €	<input type="checkbox"/> 72 00 011 (R897) 312 €	<input type="checkbox"/> 72 00 018 (R881) 399 €

Accessories					
<p>Lateral pads – height and width adjustable</p> 		<p>Lateral pads – height and width adjustable with chest strap</p> 		<p>Push handles – recommended for all Activity Chairs with dual castors</p> 	
	Depth	Height		Depth	Height
for size 0-2	13 cm	10 cm	for size 0+1	13 cm	10 cm
for size 1-2	16.5 cm	13 cm	for size 2	16.5 cm	13 cm
	Price / pair			Price / set	
<input type="checkbox"/> for size 0-2 (72 01 005) (R828)	255 €		<input type="checkbox"/> for size 0 (72 00 006) (R819)	323 €	
<input type="checkbox"/> for size 1-2 (72 02 005) (R838)	275 €		<input type="checkbox"/> for size 1 (72 01 006) (R829)	323 €	
			<input type="checkbox"/> for size 2 (72 02 006) (R839)	346 €	
			<input type="checkbox"/> 72 00 012 (R878)	207 €	

Accessories					
<p>Arm rests – height adjustable</p> 		<p>Hip support pads – padded and angle adjustable (only for use together with the armrests)</p> 		<p>Therapy tray – only for use together with the armrests</p> 	
	Width	Length		Height	Length
for size 0	6 cm	22 cm	for size 0	8 cm	14 cm
for size 1+2	7.5 cm	30.5 cm	for size 1+2	10 cm	23.5 cm
	Price / pair			Price / pair	
<input type="checkbox"/> for size 0 (72 05 007) (R827)	323 €		<input type="checkbox"/> for size 0 (72 05 008) (R814)	323 €	
<input type="checkbox"/> for size 1+2 (72 00 007) (R868)	323 €		<input type="checkbox"/> for size 1+2 (72 00 008) (R867)	323 €	
			<input type="checkbox"/> for size 0 (72 00 009) (R667)	381 €	
			<input type="checkbox"/> for size 1 (72 01 009) (R668)	381 €	
			<input type="checkbox"/> for size 2 (72 02 009) (R669)	381 €	

Accessories					
<p>Backrest extension</p> 		<p>Spinal support and tube edge</p> 		<p>Abduction wedge depth adjustable</p> 	
				Width	
				Depth	
				Height	
			for size 0+1	7.5 cm	
			for size 2	10 cm	
	Price / piece			Price / set	
<input type="checkbox"/> for size 0+1 (72 01 016) (R849)	164 €		<input type="checkbox"/> for size 0 (72 00 017) (R886)	141 €	
<input type="checkbox"/> for size 2 (72 02 016) (R856)	164 €		<input type="checkbox"/> for size 1 (72 01 017) (R887)	141 €	
			<input type="checkbox"/> for size 2 (72 02 017) (R888)	141 €	
			<input type="checkbox"/> for size 0+1 (72 01 013)	174 €	
			<input type="checkbox"/> for size 2 (72 02 013)	174 €	

Accessories

Knee lateral guide 	Knee support pad with key lock, depth adjustable 
Price / pair	Price / piece
<input type="checkbox"/> 72 00 014 (R892) 255 €	<input type="checkbox"/> for size 0 (72 00 015) (R854) 287 € <input type="checkbox"/> for size 1 (72 01 015) (R858) 287 € <input type="checkbox"/> for size 2 (72 02 015) (R859) 312 €

Harness

Chest strap 	Chest-shoulder strap  normal slimline	Thigh straps 	Groin harness 
Price / piece	Price / piece	Price / pair	Price / piece
<input type="checkbox"/> for size 0 (72 00 020) (R802) 126 € <input type="checkbox"/> for size 1 (72 01 020) (R863) 126 € <input type="checkbox"/> for size 2 (72 02 020) (R807) 126 €	<input type="checkbox"/> normal for size 0 (72 00 021) (R834) 187 € <input type="checkbox"/> normal for size 1 (72 01 021) (R864) 187 € <input type="checkbox"/> normal for size 2 (72 02 021) (R889) 187 € <input type="checkbox"/> slimline for size 1 (72 04 021) (R882) 187 € <input type="checkbox"/> slimline for size 2 (72 03 021) (R826) 187 €	<input type="checkbox"/> for size 0 (72 00 022) (R811) 126 € <input type="checkbox"/> for size 1 (72 01 022) (R865) 126 € <input type="checkbox"/> for size 2 (72 02 022) (R813) 126 €	<input type="checkbox"/> for size 0 (72 00 023) (R845) 220 € <input type="checkbox"/> for size 1 (72 01 023) (R866) 220 € <input type="checkbox"/> for size 2 (72 02 023) (R846) 220 €

Footplate + Accessories

Footplate – height adjustable, can be folded up and swung away for transfer 	Ankle positioner – with socket lock, only for use together with the footplate 							
Lower leg length	Price / piece	Upcharge / pair						
<table border="1" style="width: 100%; border-collapse: collapse;"> <tr> <td style="width: 33%; text-align: center;">for size 0</td> <td style="width: 33%; text-align: center;">for size 1</td> <td style="width: 33%; text-align: center;">for size 2</td> </tr> <tr> <td style="text-align: center;">23 - 30 cm</td> <td style="text-align: center;">30 - 42 cm</td> <td style="text-align: center;">38 - 51 cm</td> </tr> </table>	for size 0	for size 1	for size 2	23 - 30 cm	30 - 42 cm	38 - 51 cm	<input type="checkbox"/> for size 0 (72 00 029) (R847) 578 € <input type="checkbox"/> for size 1 (72 01 029) (R848) 578 € <input type="checkbox"/> for size 2 (72 02 029) (R857) 578 €	<input type="checkbox"/> for size 0+1 (72 01 026) (R899) 126 € <input type="checkbox"/> for size 2 (72 02 026) (R855) 126 €
for size 0	for size 1	for size 2						
23 - 30 cm	30 - 42 cm	38 - 51 cm						

Footplate + Accessories

Sandals with foot straps only for use together with the footplate	Wedges – only for use together with the footplate and sandals 
Price / pair	Upcharge / pair
<input type="checkbox"/> for size 0 (72 00 027) (R944) 126 € <input type="checkbox"/> for size 1 (72 01 027) (R954) 126 € <input type="checkbox"/> for size 2 (72 02 027) (R964) 126 €	<input type="checkbox"/> for size 0 (72 00 028) (R697) 100 € <input type="checkbox"/> for size 1 (72 01 028) (R698) 100 € <input type="checkbox"/> for size 2 (72 02 028) (R699) 100 €

tina.

Invoice address:**Dispatch address:**
 See invoice address

 Order
 Cost estimate

Customer No.: _____

Orderer: _____

Date: _____

Signature: _____

Commission:**The cradle subframe with cradle system.**

- Electrical height adjustment via hand switch
- 12" inflated rear wheels with drum brake, 8" PU front wheels
- Universal mounting points for all types of cradles
- Frame colour: white aluminium (silver)

Dimensions - cradle subframe

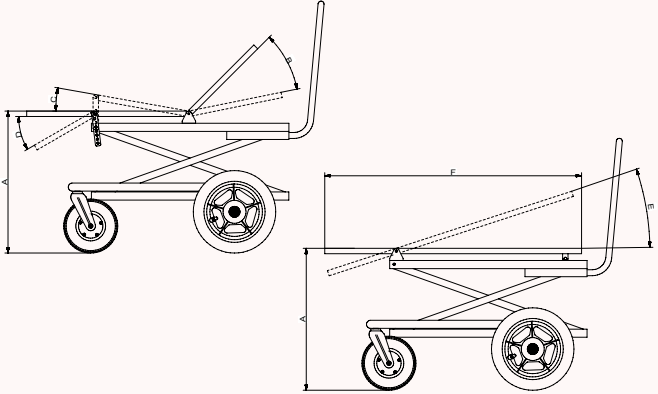
		for three-piece cradle system	for one-piece cradle system	
A	Height of cradle support from floor	53 - 79 cm	53 - 79 cm	
B	Adjustable back angle	0° - 50°	-	
C	Seat angle (adjustable in steps)	0° - 18°	-	
D	Adjustable foot angle	0° - 50°	-	
E	Inclination angle lying surface	-	0° - 20°	
F	Receptive length for cradles	-	95 cm	
	Base frame width	64 cm	64 cm	
	Max. load	100 kg	100 kg	
	Weight	44 kg	44 kg	

Basic model cradle subframe

tina. (for three-piece cradle system) with electrical back adjustment, adjustable seat and foot angle		tina. (for one-piece cradle system) with electrical inclination angle adjustment of the lying surface	
	Price / piece		Price / piece
<input type="checkbox"/> 4000101	4.661 €	<input type="checkbox"/> 4000201	4.661 €

Dimensions - cradle system

		Size 1	Size 2	Size 3	Size 4
A	Width	60 cm	70 cm	70 cm	70 cm
B	Length of head section	45 cm	60 cm	75 cm	90 cm
C	Centre section length	35 cm	35 cm	35 cm	35 cm
D	Length of foot section	35 cm	45 cm	55 cm	65 cm
E	Total length	115 cm	140 cm	165 cm	190 cm
F	Height	12 cm	12 cm	12 cm	12 cm

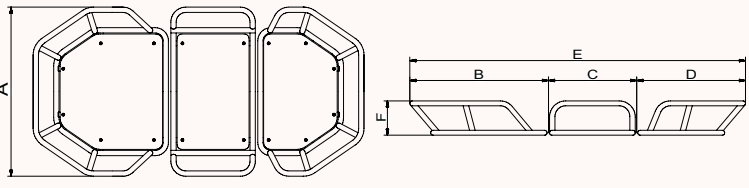
Cradle system
Head section

Note: Size 4 includes an extended push handle and anti-tip device!

	Length	Width
Size 1	45 cm	60 cm
Size 2	60 cm	70 cm
Size 3	75 cm	70 cm
Size 4	90 cm	70 cm

Seat section

	Length	Width
Size 1	35 cm	60 cm
Size 2-4	35 cm	70 cm

Leg section

	Length	Width
Size 1	35 cm	60 cm
Size 2	45 cm	70 cm
Size 3	55 cm	70 cm
Size 4	65 cm	70 cm

Custom modification is possible.

Custom modification is possible.

Custom modification is possible.

	Price / piece		Price / piece		Price / piece
<input type="checkbox"/> Size 1 (40 01 102)	338 €	<input type="checkbox"/> Size 1 (40 01 103)	216 €	<input type="checkbox"/> Size 1 (40 01 104)	338 €
<input type="checkbox"/> Size 2 (40 02 102)	338 €	<input type="checkbox"/> Size 2-4 (40 02 103)	216 €	<input type="checkbox"/> Size 2 (40 02 104)	338 €
<input type="checkbox"/> Size 3 (40 03 102)	338 €			<input type="checkbox"/> Size 3 (40 03 104)	338 €
<input type="checkbox"/> Size 4 (40 04 102)	718 €			<input type="checkbox"/> Size 4 (40 04 104)	338 €

Mattresses

Vacuum mattress – for tina. incl. valve and electric pump with two-way switch



	Length	Width
Size 1	ca. 125 cm	ca. 65 cm
Size 2	ca. 150 cm	ca. 75 cm
Size 3	ca. 175 cm	ca. 75 cm
Size 4	ca. 200 cm	ca. 80 cm

Cover made of breathable fabric with insert made of spacer fabric (for adjacent vacuum mattress)

Support mattress – with edge of foam



	Length	Width
Size 1	115 cm	60 cm
Size 2	140 cm	70 cm
Size 3	165 cm	70 cm
Size 4	190 cm	70 cm

Custom modification is possible.

	Price / piece		Price / piece		Price / piece
<input type="checkbox"/> Size 1 (41 01 202)	2.830 €	<input type="checkbox"/> for size 1 (41 01 201)	340 €	<input type="checkbox"/> Size 1 (40 01 105)	698 €
<input type="checkbox"/> Size 2 (41 02 202)	2.830 €	<input type="checkbox"/> for size 2 (41 02 201)	340 €	<input type="checkbox"/> Size 2 (40 02 105)	698 €
<input type="checkbox"/> Size 3 (41 03 202)	2.830 €	<input type="checkbox"/> for size 3 (41 03 201)	340 €	<input type="checkbox"/> Size 3 (40 03 105)	698 €
<input type="checkbox"/> Size 4 (41 04 202)	2.830 €	<input type="checkbox"/> for size 4 (41 04 201)	340 €	<input type="checkbox"/> Size 4 (40 04 105)	798 €

Accessories

Extended push handle – for head sections larger than 75 cm (already included with head section size 4)



Anti tip – pivoting, adjustable in height (already included with head section size 4)

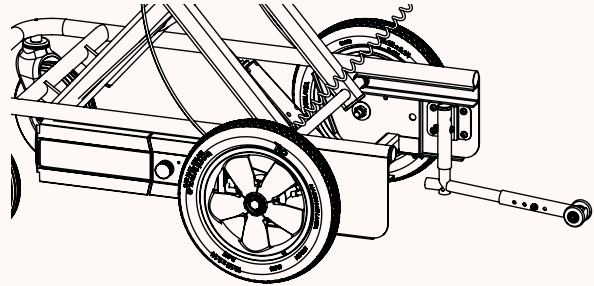

	Upcharge / piece		Price / piece
<input type="checkbox"/> 40 00 120	140 €	<input type="checkbox"/> 40 00 140	240 €

Accessories

Tray for medical devices – height adjustable, with slotted holes for strap (25 mm) to secure the medical devices



Width	43cm
Depth	40cm

Infusion holder – telescopic



	Price / piece		Price / piece
<input type="checkbox"/> 40 09 011	350 €	<input type="checkbox"/> 40 00 010	223 €

Accessories

Preparation of the frame for mounting an E-Fixdrive 12"

Installation of the delivered E-Fix-drive

Large support cushion

Wide seat belt – strap with sliding unit to fix on the tube frame

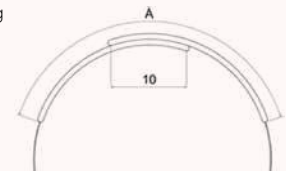
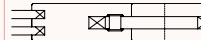

Please provide the required total length (A): ____ cm

	Net price (not discountable)		Net price (not discountable)		Price / piece		Price / piece
<input type="checkbox"/> 40 00 130	201 €	<input type="checkbox"/> 40 00 131	152 €	<input type="checkbox"/> 40 00 005	155 €	<input type="checkbox"/> 40 00 009	216 €

Our fabric collection.

**Value your products with
our fabrics.**

Further information can be
found from page 156.

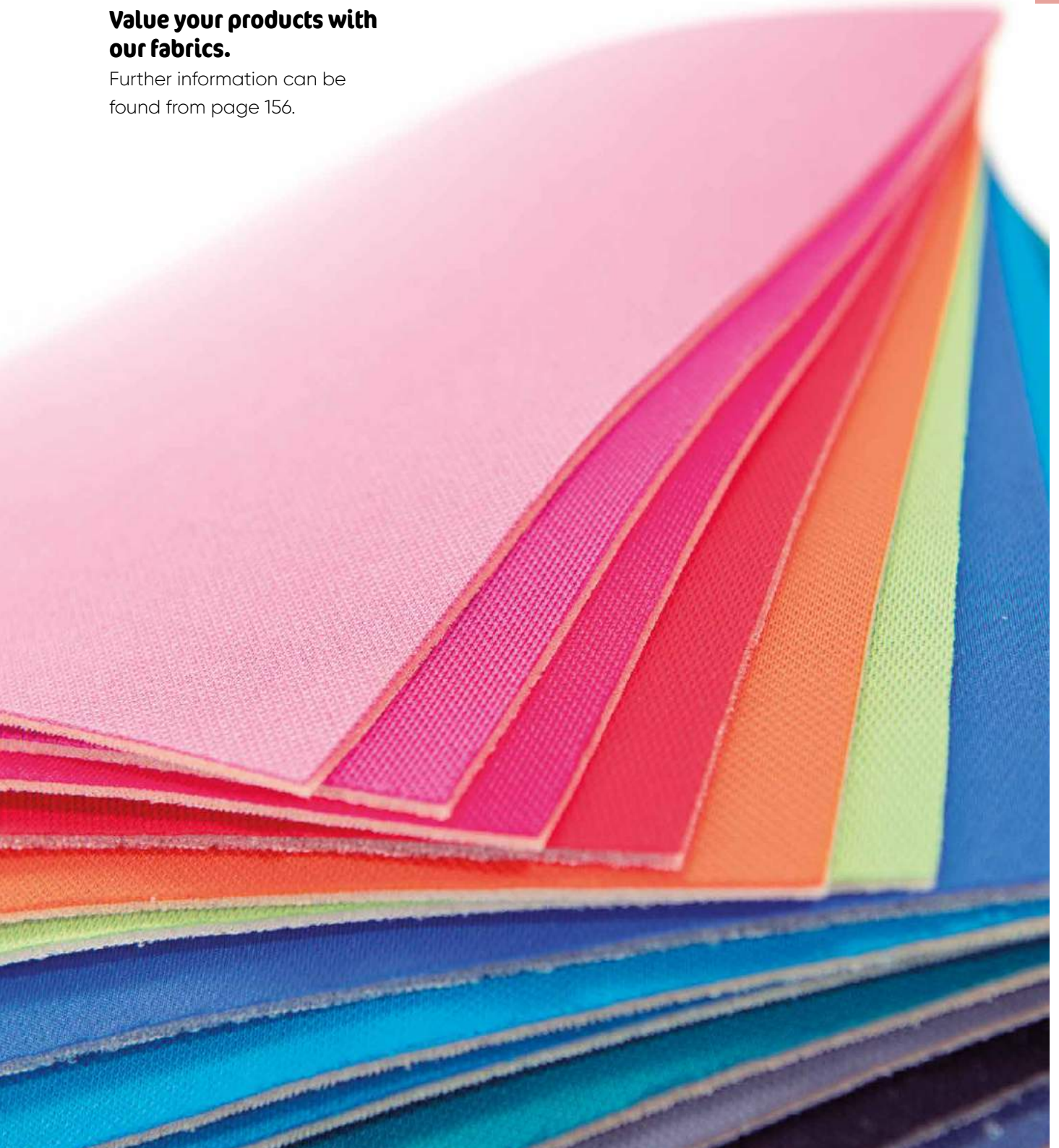

Invoice address:**Dispatch address:**
 See invoice address

 Order
 Cost estimate

Customer No.: _____

Orderer: _____

Date: _____

Signature: _____

Commission:**The pivoting car seat.**

- Seat and back plate made of aluminium with back angle adjustment
- Removable pads and fixed lateral pads
- Incl. height adjustable and padded headrest and 5-point brace straps
- Three-point strap guidance, frame colour: black – silky matt, RAL 9005
- Tested and approved based on ECE-44/03

HMV-No.: 26.11.06.0009

Dimensions - basic model

		Size 1		Size 2		Size 3	
		a	b	a	b	a	b
A	Seat depth	25 cm	30 cm	30 cm	35 cm	35 cm	40 cm
B	Seat width	28 cm		32 cm		36 cm	
C	Back height	40 cm		48 cm		56 cm	
D	Headrests height	59 - 69 cm		65 - 77 cm		76 - 86 cm	
E	Lateral pad height	25 - 33 cm		32 - 40 cm		36 - 44 cm	
	Tilt-in-space*	0°/15°		0°/10°		0°/10°	
F	Chest width	14 - 25 cm		16 - 29 cm		16 - 32 cm	
G	Back angle	90° - 108°		90° - 108°		90° - 108°	
	Max. load	30 kg		45 kg		60 kg	

* When using the footplate and tilt adjustment

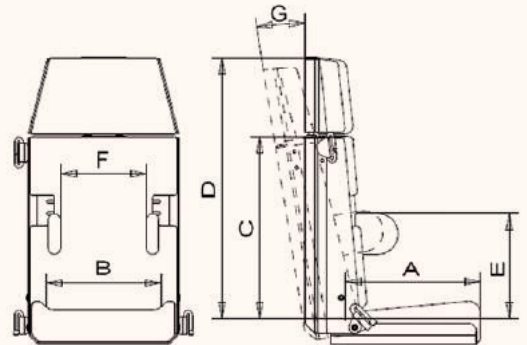

Basic model



sascha. size 1		sascha. size 2		sascha. size 3	
	Price / piece		Price / piece		Price / piece
<input type="checkbox"/> Size 1 a (1401001)	1.790 €	<input type="checkbox"/> Size 2 a (1402001)	1.856 €	<input type="checkbox"/> Size 3 a (1403001)	1.897 €
<input type="checkbox"/> Size 1 b (1401100)	1.790 €	<input type="checkbox"/> Size 2 b (1402100)	1.856 €	<input type="checkbox"/> Size 3 b (1403100)	1.897 €

Covers				
Fabric design Black / Red (No. 105 + 91) 	Fabric design Black / Light blue (No. 105 + 106) 	Fabric design Black / Spacer fabric (No. 105 + 47) 	Fabric design Black / Pink-Telemagenta (No. 105 + 114) 	
Price	Price	Price	Price	Price
<input type="checkbox"/> 9100206 incl.	<input type="checkbox"/> 9100230 incl.	<input type="checkbox"/> 9100231 incl.	<input type="checkbox"/> 9100232 incl.	

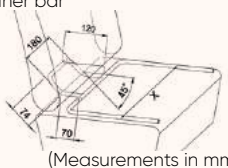
Lateral pads		
Standard setting range for fixed lateral pads The max. chest width reduces by 2 cm on each side when using the pluggable lateral pads For size 1 a / b Height from seat to armpit 25 - 33 cm Width of chest area 14 - 25 cm For size 2 a / b Height from seat to armpit 32 - 40 cm Width of chest area 16 - 29 cm For size 3 a / b Height from seat to armpit 36 - 44 cm Width of chest area 16 - 32 cm	Setting range for tailored lateral pads outside of the adjacent dimensionse Width of chest area _____ cm Width of chest area outside of the adjacent dimensions on request.	Lateral pads – pluggable, easier to get in and out, incl. cover 
		Upcharge / piece
		<input type="checkbox"/> for size 1, mounted on right (14 01 007) 203 € <input type="checkbox"/> for size 1, links montiert (14 01 008) 203 € <input type="checkbox"/> for size 2, mounted on right (14 02 007) 203 € <input type="checkbox"/> for size 2, links montiert (14 02 008) 203 € <input type="checkbox"/> for size 3, mounted on right (14 03 007) 203 € <input type="checkbox"/> for size 3, links montiert (14 03 008) 203 €
	Upcharge	
	<input type="checkbox"/> 14 00 009	208 €

Strap guide		Accessories	
Shoulder strap guide 14 00 002: Shoulder strap guide mounted on right (standard configuration, if nothing else stated) 14 00 003: Shoulder strap guide mounted on left 14 00 004: Shoulder strap guide mounted on left	Lateral guide and torso support pad as safety impact protection, incl. cover and fixing strap 	Abduction wedge – pluggable, with bracket and cover 	ISOFIX bracket 
Price / piece	Price / piece	Price / piece	Price / set
<input type="checkbox"/> Right (14 00 002) incl. <input type="checkbox"/> Left (14 00 003) incl. <input type="checkbox"/> both sides (14 00 004) 81 €	<input type="checkbox"/> for size 1 (14 01 005) 661 € <input type="checkbox"/> for size 2 (14 02 005) 661 € <input type="checkbox"/> for size 3 (14 03 005) 661 €	<input type="checkbox"/> for size 1 (14 01 006) 300 € <input type="checkbox"/> for size 2 (14 02 006) 300 € <input type="checkbox"/> for size 3 (14 03 006) 300 €	<input type="checkbox"/> for size 1 (14 01 010) 213 € <input type="checkbox"/> for size 2 (14 02 010) 213 € <input type="checkbox"/> for size 3 (14 03 010) 213 €

Pivoting device		
Pivoting device with tilt adjustment incl. footplate support and retainer bar   (Measurements in mm)	Right pivoting	Left pivoting
	Price / set	Price / set
	<input type="checkbox"/> X = 394 mm for size 1 (14 01 002) 411 € <input type="checkbox"/> X = 454 mm for size 2 (14 02 002) 411 € <input type="checkbox"/> X = 494 mm for size 3 (14 03 002) 411 €	<input type="checkbox"/> X = 394 mm for size 1 (14 01 102) 411 € <input type="checkbox"/> X = 454 mm for size 2 (14 02 102) 411 € <input type="checkbox"/> X = 494 mm for size 3 (14 03 102) 411 €

Accessories		Harnessen	
Tilt adjustment on base plate incl. footplate support 	Footplate – removable (only for use in combination with the pivoting device or tilt adjustment) 	Please use our pricelist flexi-activ (see from page 152)	
Price / piece	Price / piece		
<input type="checkbox"/> for size 1 (14 01 003) 154 € <input type="checkbox"/> for size 2 (14 02 003) 154 € <input type="checkbox"/> for size 3 (14 03 003) 154 €	<input type="checkbox"/> for size 1 (14 01 004) 144 € <input type="checkbox"/> for size 2 (14 02 004) 144 € <input type="checkbox"/> for size 3 (14 03 004) 144 €		

siggi combi isofix.

Invoice address:
Dispatch address:
 See invoice address

 Order
 Cost estimate

Customer No.: _____

Orderer: _____

Date: _____

Signature: _____

Commission:
The special car seat.

- Based on the BeSafe iZi Combi X4 ISOfix and was verified and approved with special accessories according to ECE-44/04
- From 0 - 18 kg to be installed facing against the flow of traffic by way of ISOFIX
- From 9 - 18 kg to be installed with the flow of traffic
- With three different sitting / resting positions
- The patented belt guide is included in the basic model
- With serial 5-point belt incl. shoulder pad
- With integrated support leg, additional side impact protection SIP+ and chock
- Height of head support and belt can be adjusted easily with one move
- High quality expanded polystyrene (EPS) in head, torso and upper thigh area ensures particularly high security in case of side impact
- Fabric design: Fresh Black Cap

0 to 18 kg

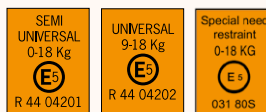

HMV-No.: 26.11.06.0021

Dimensions - basic model

A	Seat width front	32 cm
	Seat width rear	27 cm
B	Seat surface depth	25 cm
C	Height of headrest	48 - 60 cm
	Seat angle	facing the direction of travel 30° / 37,5° / 45° facing away from the direction of travel* 25° / 32,5° / 40°
D	Total width	46 cm
E	Total height	68 cm
	Group	0 - 18 kg
	Weight	16 kg

* at a vehicle seat angle of 5°

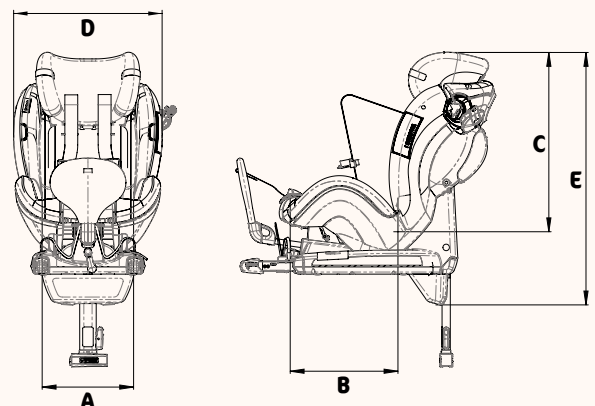
Basic model

	Price / piece
<input type="checkbox"/> 16 02 300	1.528 €



Accessories

Thorax pads – adjustable in height and width, for chest width 17 – 21 cm



Price / pair

□ 16 00 001 200 €

Abductor wedge – hook and loop fastener



Price / piece

□ 16 00 002 94 €

Arm rest cushion



Price / piece

□ 16 01 002 220 €

Accessories

Positioning jacket – hook and loop fastener



Price / piece

□ 16 01 004 84 €

Baby cushion



Price / piece

□ 16 01 006 84 €

Sun protection



Price / piece

□ 16 01 005 89 €

The siggi combi isofix.

The child car seat **siggi combi isofix** resembles the predecessor **siggi combi** on many levels. However, this version offers the advantage that it can be installed with ISOFIX also against the flow of traffic. It is thus ensured that the seat is always anchored firmly in the car and remains in position also in case of an accident or severe braking.

Side Impact Protection + (SIP+)

The SIP+ was developed especially to provide additional protection for the child in the event of a side impact. It is manufactured from energy-absorbing material, which additionally reduces the forces on the head and neck of the child by up to 20%.

Space-saving installation and easy handling

The length of the ISOFIX-arms can be adjusted in steps during the installation against the flow of traffic. The **siggi combi isofix** can thus be installed in the car precisely in accordance with the personal space requirements. With an extendable support leg and adjustable roll cage, the car seat is installed safely and sturdy within seconds. Installing the seat with the direction of traffic, the **siggi combi isofix** is secured with the three-point belt in the vehicle. The height of the head support and integrated 5-point belt can be adjusted quick and easy in eight different stages in just one move.

Optimum seating position

Due to its construction, the **siggi combi isofix** provides the child with optimum seating or resting positions during the drive. The multiply adjustable seating position can be easily adjusted also after installation and/or during the drive.

siggi 3 fix.

Invoice address:**Dispatch address:**
 See invoice address

 Order
 Cost estimate

Customer No.: _____

Orderer: _____

Date: _____

Signature: _____

Commission:**The car seat that grows with you.**

- Based on the BeSafe iZi Up X3 FIX and was verified and approved with special accessories according to ECE-44/04
- With ISOFIX attachment points for installation in the direction of travel (use in case of non-existent bracket for ISOFIX is also permitted)
- With innovative side impact rotation (SIR) when installed with ISOFIX
- Height of head support and belt can be adjusted easily with one move
- Automatic adjustment of the shoulder belt guide to the back height
- Headrest padding with the possibility of customization
- Adjustable rest position, back angle adjustment by 20 °
- Fabric design: Fresh Black Cap

 15 to
36 kg

HMV-No.: 26.11.06.0023

 ECE R44/04
Special Needs
15-36 kg
E4
0444 3808S

Dimensions - basic model

A	Seat width at front	32 cm
B	Seat width at rear	27 cm
C	Seat surface depth	25 cm
D	Height of headrest	55 - 75 cm
E	Total width	53 cm
F	Total height	68 - 87 cm
	Back angle	90° / 110°
	Group	15 - 36 kg
	Weight	8 kg

Basic model

Price / piece

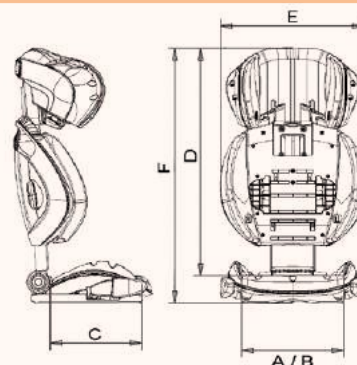
 1604 100 1.244 €

Accessories

<p>Thorax pads – adjustable in height and width, for chest width 23 – 28 cm</p> 	<p>Abductor wedge – hook and loop fastener</p> 	<p>Lateral guide and torso support pad – as safety impact protection, incl. cover and fixing strap</p> 
<p>Price / pair □ 16 04 005 200 €</p>	<p>Price / piece □ 16 00 002 94 €</p>	<p>Price / piece □ 16 04 006 373 €</p>

Accessories

<p>Positioning jacket – with zipper</p> 	<p>Pelvic positioning harness</p> 	<p>Footplate – for installation in the footwell, adjustable in height and angle</p> 						
<p>Price / piece □ 16 04 003 241 €</p>	<p>Price / set □ 16 04 004 241 €</p>	<table border="1"> <thead> <tr> <th>Width</th> <th>Height</th> <th>Depth</th> </tr> </thead> <tbody> <tr> <td>36 cm</td> <td>19 – 31 cm</td> <td>26 cm</td> </tr> </tbody> </table> <p>Price / piece □ 16 04 007 204 €</p>	Width	Height	Depth	36 cm	19 – 31 cm	26 cm
Width	Height	Depth						
36 cm	19 – 31 cm	26 cm						

The siggi 3 fix.

The child car seat **siggi 3 fix.** resembles the predecessor **siggi 3.** on many levels. However, this version offers the advantage that it can be installed with ISOFIX. It is thus ensured that the seat is always anchored firmly in the car and remains in position also in case of an accident or severe braking. When installed with ISOFIX, the **siggi 3 fix.** also features the patented Side Impact Rotation (SIR).

Side Impact Rotation (SIR)

In case of a lateral accident, the **siggi 3 fix.** turns away from the point of impact. In this way, the child is better protected – both from the forces acting, as well as from flying glass splinters and car parts. This patented sideways movement is made possible only by attachment with ISOFIX.

Easy installation – with and without ISOFIX

The **siggi 3 fix.** is easy to install in the car. Here you can choose whether the **siggi 3 fix.** is attached with or without ISOFIX. The child must always – regardless of the installation – be secured with the three-point belt of the car, which is threaded through the belt guide of the car seat.

Long service life

siggi 3 fix. is one of the few child car seats suitable for children up to a height of 150 cm. The easy one-step height adjustment allows for an ideal fit from kindergarten age to the end of the time when a child car seat is needed. The child car seat grows along with the child and the position of the three-point belt adapts automatically without it being able to slip out of the seat belt guide of the child car seat.

Security

The **siggi 3 fix.** was developed with great care, manufactured and tested by independent test institutes according to ECE R44-04. In addition, **siggi 3 fix.** was subjected to an additional test for child car seats with accessories for children with a disability (Special need restraint for disabled children). Here, the special accessories and the effects in the event of an accident was checked.

freddy.

Invoice address:
Dispatch address:
 See invoice address

 Order
 Cost estimate

Customer No.: _____

Orderer: _____

Date: _____

Signature: _____

Commission:
The compact seat pan subframe.

- Tilt adjustment of the seat pan via gas pressure spring 300N
- Adjustable seat depth using depth adjustable back unit
- Back and push grips, angle and height adjustable
- Incl. support head as a base plate for trapezoidal and external adapter, height and seat depth adjustment
- Incl. socket for footplate
- Incl. rear wheels with quick-release axle and drum brake

HMV-No.: 26.99.01.1033

(with 16" rear wheels)

HMV-No.: 26.99.01.1079

 (with 20" to 24" rear wheels
and grip ring)

Basic model

freddy. size 0		freddy. size 1		freddy. size 2		freddy. size 3	
Price / piece		Price / piece		Price / piece		Price / piece	
<input type="checkbox"/> 25 00 000	2.195 €	<input type="checkbox"/> 25 01 000	2.195 €	<input type="checkbox"/> 25 02 000	2.195 €	<input type="checkbox"/> 25 03 000	2.195 €

Frame colours

Turquoise blue 	Lasurit blue metallic 	White aluminium (silver) 	Dormant Red 	Pure white 	Anthrazit metallic 	Black satin finish 
 Price	Price	Price	Price	Price	Price	Price
<input type="checkbox"/> 92 00 016 incl.	<input type="checkbox"/> 92 00 010 incl.	<input type="checkbox"/> 92 00 002 incl.	<input type="checkbox"/> 92 00 003 incl.	<input type="checkbox"/> 92 00 100 incl.	<input type="checkbox"/> 92 00 014 incl.	<input type="checkbox"/> 92 00 005 incl.

Dimensions - basic model						
		Size 0	Size 1	Size 2	Size 3	
A*	Min. seat height	43cm	43cm	43cm	43cm	
B	Short seat depth	23 - 33 cm	27 - 37 cm	-	-	
B	Standard Seat depth	28 - 38 cm	32 - 42 cm	40 - 50 cm	40 - 50 cm	
	Tilt-in-space	(-)5° - 30°	(-)5° - 30°	(-)5° - 30°	(-)5° - 30°	
C	Width between rear wheels (with clothing guard) = Max. outer width of seat pan	39 cm	44 cm	49 cm	54 cm	
D	Frame width	inside	28 cm	33 cm	38 cm	43 cm
		outside	35 cm	40 cm	45 cm	50 cm
E	Seat frame width	25 cm	30 cm	35 cm	35 cm	
F**	Total length	63 - 79 cm	63 - 79 cm	66 - 82 cm	71 - 87 cm	
G	Total width	58 cm	63 cm	68 cm	73 cm	
	Max. load	90 kg	90 kg	120 kg	120 kg	
	Weight	from 14 kg	from 14 kg	from 14 kg	from 14 kg	

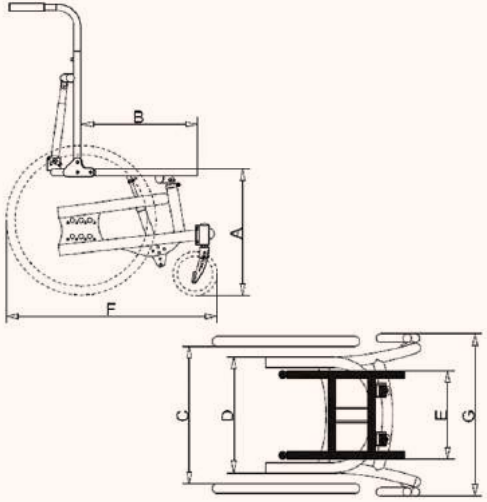

* Depending on wheel size, seat height adjustable by 10 cm
 ** Depending on the wheel size

Versions		Push handles / bar		
Basic frame design with additional gas pressure spring (300N) – for sizes 2+3 (recommended from a patient weight of 90 kg incl. seat pan), retrofitting not possible	Standard push handles		Push bar	
Upcharge / piece		Price / pair	Upcharge / piece	
<input type="checkbox"/> for size 2 (25 02 020)	430 €	incl.	<input type="checkbox"/> for size 0 (25 00 002)	152 €
<input type="checkbox"/> for size 3 (25 03 020)	430 €		<input type="checkbox"/> for size 1 (25 01 002)	152 €
		<input type="checkbox"/> for size 2+3 (25 02 002)	152 €	

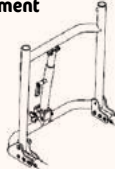
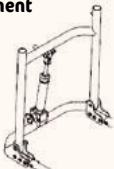
Back			
Back angle adjustment via snap joint		Centralised fast mechanical adjustment mechanical	
		Centralised fast mechanical adjustment via gas pressure spring (300 N)	
Please note that one of these options must be selected.			
	Price / piece		Upcharge / set
<input type="checkbox"/> for size 0 (25 00 003)	incl.	<input type="checkbox"/> for size 0 (25 00 004)	incl.
<input type="checkbox"/> for size 1 (25 01 003)	incl.	<input type="checkbox"/> for size 1 (25 01 004)	incl.
<input type="checkbox"/> for size 2+3 (25 02 003)	incl.	<input type="checkbox"/> for size 2+3 (25 02 004)	incl.
		<input type="checkbox"/> for size 0 (25 00 005)	95 €
		<input type="checkbox"/> for size 1 (25 01 005)	95 €
		<input type="checkbox"/> for size 2+3 (25 02 005)	95 €

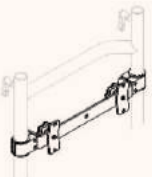
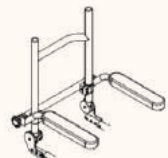
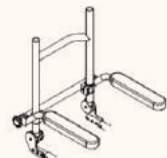
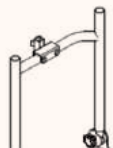
Accessories			
Back rest support of seat unit	Armrests – mounted to the back tubes, adjustable width and angle	Armrests – mounted to the back tubes, adjustable width and folding	Headrest bracket – to mount square tubes (15x15 mm)
			
Price / set		Price / set	Price / piece
<input type="checkbox"/> for size 0 (25 00 007)	226 €	<input type="checkbox"/> for size 0 (25 00 025)	317 €
<input type="checkbox"/> for size 1 (25 01 007)	226 €	<input type="checkbox"/> for size 1 (25 01 025)	317 €
<input type="checkbox"/> for size 2+3 (25 02 007)	226 €	<input type="checkbox"/> for size 2+3 (25 02 025)	317 €
		<input type="checkbox"/> for size 0 (25 00 026)	317 €
		<input type="checkbox"/> for size 1 (25 01 026)	317 €
		<input type="checkbox"/> for size 2+3 (25 02 026)	317 €
		<input type="checkbox"/> 25 00 019	97 €



Front wheels

6" front wheels with rubber coat 150 x 30 mm, colour: black (standard configuration, if nothing else stated) 	Full rubber front wheels 140 x 40 mm, colour: black 	7" front wheels with rubber coat 180 x 45 mm, colour: black 	Front wheels – individual ____ x ____ mm
Price / pair	Upcharge / pair	Upcharge / pair	Price / pair
<input type="checkbox"/> Inflated tyres (25 00 021) incl. <input type="checkbox"/> Puncture-resistant (25 00 022) incl.	<input type="checkbox"/> 25 01 022 43 €	<input type="checkbox"/> Inflated tyres (25 01 021) 43 €	<input type="checkbox"/> 25 09 021 on request

Rear wheels

Rear wheels inflated tyres with quick-release axle and drum brake, colour: black 	Puncture-resistant rear wheels with quick-release axle and drum brake, colour: black 	Clothing guard – fixed 	Clothing guard – removable 
Upcharge / set	Upcharge / set	Price / pair	Price / pair
<input type="checkbox"/> 16" (25 00 008) incl. <input type="checkbox"/> 20" (25 01 008) incl. <input type="checkbox"/> 22" (25 02 008) incl. <input type="checkbox"/> 24" (25 03 008) 107 €	<input type="checkbox"/> 16" (25 00 009) incl. <input type="checkbox"/> 20" (25 01 009) incl. <input type="checkbox"/> 22" (25 02 009) incl. <input type="checkbox"/> 24" (25 03 009) 107 €	<input type="checkbox"/> 16" (25 00 011) 232 € <input type="checkbox"/> 20" (25 01 011) 232 € <input type="checkbox"/> 22" (25 02 011) 232 € <input type="checkbox"/> 24" (25 03 011) 232 €	<input type="checkbox"/> 16" (25 00 018) 321 € <input type="checkbox"/> 20" (25 01 018) 321 € <input type="checkbox"/> 22" (25 02 018) 321 € <input type="checkbox"/> 24" (25 03 018) 321 €

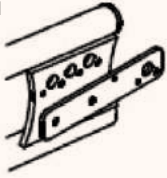
Rear wheels

Spoke guard – for rear wheels, transparent 	Wheel base extension (not possible in combination with the bracket for Viamobil / Scalamobil and S-Max) 	Knee lever brake with bracket 
Price / pair	Price / pair	Price / pair
<input type="checkbox"/> 20" (25 01 010) 184 € <input type="checkbox"/> 22" (25 02 010) 184 € <input type="checkbox"/> 24" (25 03 010) 184 €	<input type="checkbox"/> 25 00 014 132 €	<input type="checkbox"/> 16" (25 00 015) 237 € <input type="checkbox"/> 20" (25 01 015) 237 € <input type="checkbox"/> 22" (25 02 015) 237 € <input type="checkbox"/> 24" (25 03 015) 237 €

Accessories

Anti tip bar – adjustable in height and length, also pivoting (not possible in combination with the bracket for Viamobil / Scalamobil and S-Max) 	Tilting device (not possible in combination with the bracket for Viamobil / Scalamobil and S-Max) 	Tilting device for dual anti tip bar mounted on the yoke (not possible in combination with the bracket for Viamobil / Scalamobil and S-Max) 	Tilting device for dual anti tip bar and wheel base extension (not possible in combination with the bracket for Viamobil / Scalamobil and S-Max) 
Price / piece	Price / piece	Price / piece	Price / piece
<input type="checkbox"/> Right attachment (25 01 013) 170 € <input type="checkbox"/> Left attachment (25 02 013) 170 €	<input type="checkbox"/> Right attachment (25 01 012) 75 € <input type="checkbox"/> Left attachment (25 02 012) 75 €	<input type="checkbox"/> Right attachment (25 03 012) 75 € <input type="checkbox"/> Left attachment (25 04 012) 75 €	<input type="checkbox"/> Right attachment (25 05 012) 75 € <input type="checkbox"/> Left attachment (25 06 012) 75 €

Adapter

Support head as a base plate
for trapezoidal and external adapters

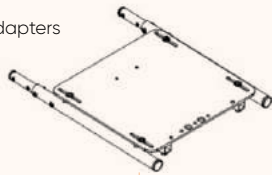

Trapezoidal adapter

lower part

top part

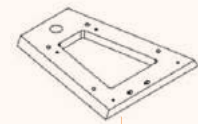

Length

Front width

Rear width

	short seat depth	stand. seat depth	lower part size 0	20 cm	21 cm	14.5 cm
for size 0	23 - 33 cm	28 - 38 cm	lower part size 1	26 cm	26 cm	17.5 cm
for size 1	27 - 37 cm	32 - 42 cm	top part size 0	19 cm	16.5 cm	9.8 cm
for size 2+3	-	40 - 50 cm	top part size 1	25 cm	21.5 cm	12.7 cm
			Price / piece			Price / piece
<input type="checkbox"/> for size 0, short (25 00 116)		incl.	<input type="checkbox"/> lower part size 0 (25 00 034)			179 €
<input type="checkbox"/> for size 0, standard (25 00 016)		incl.	<input type="checkbox"/> lower part size 1 (25 01 034)			179 €
<input type="checkbox"/> for size 1, short (25 01 116)		incl.	<input type="checkbox"/> top part size 0 (25 00 035)			117 €
<input type="checkbox"/> for size 1, standard (25 01 016)		incl.	<input type="checkbox"/> top part size 1 (25 01 035)			117 €
<input type="checkbox"/> for size 2+3, standard (25 02 016)		incl.				

Retainer systems

Securing eyes

to transport the chassis in the car, incl. mounting to the chassis, universally combinable e.g. with systems of Q-Straint, etc. (tested according to ISO 7176/19)

Power junction system

to transport the chassis by car (**freddy.** is tested with the power junction system according to ISO 7176/19 and the system itself according to DIN 75078-2)

Bracket for Viamobil / Scalamobil as an assembly set
- only possible for **freddy.**
sizes 2+3

- only possible with use of „back angle adjustment by snap joint“
- please use accessories from Alber (anti tip bar, tilting device)

Bracket for S-Max as assembly set
- only possible for **freddy.**
sizes 2+3

- only possible with use of „back angle adjustment by snap joint“
- please use accessories from AAT (anti tip bar, tilting device)

Power junction system assembly at Schuchmann

Net price (not discountable) / set	Net price (not discountable) / set	Net price (not discountable) / set	Net price (not discountable) / set	Net price (not discountable)
<input type="checkbox"/> for size 0 (25 00 033) 176 €	<input type="checkbox"/> 25 02 030 362 €	<input type="checkbox"/> 25 00 031 284 €	<input type="checkbox"/> 25 00 032 284 €	<input type="checkbox"/> 25 01 030 138 €
<input type="checkbox"/> for size 1-3 (25 01 033) 176 €				

Footplate for subframes

Aluminium footplate – with heel edge, height and knee angle adjustment

	Width
Size 1	26 cm
Size 2	30 cm
Size 3	36 cm
Price / piece	
<input type="checkbox"/> Size 1 (25 01 036)	220 €
<input type="checkbox"/> Size 2 (25 02 036)	220 €
<input type="checkbox"/> Size 3 (25 03 036)	220 €

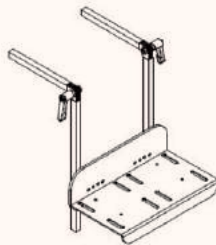

Aluminium footplate – with heel edge, height, knee and foot angle adjustment, also folding

	Width
Size 1	28 cm
Size 2	34 cm
Size 3	40 cm
Price / piece	
<input type="checkbox"/> Size 1 (25 01 037)	290 €
<input type="checkbox"/> Size 2 (25 02 037)	290 €
<input type="checkbox"/> Size 3 (25 03 037)	290 €

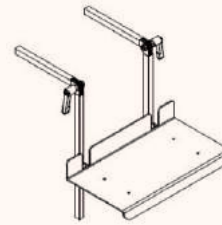
Accessories

Knee angle adjustment with snap joints

for adjacent footplates, to strengthen the knee-angle locking, material = stainless steel

	Upcharge / set
<input type="checkbox"/> 25 00 038	100 €

Split footplate for subframes

Split footplates – adjustable in height and width, swing away



Especially suitable for users with windsweeping

	Size 1	Size 2
Lower leg length (base plate to footrest)	16 - 28 cm	26 - 38 cm
recommended for lower leg length	24 - 36 cm	34 - 46 cm
Min. width	30 cm	36 cm
Price / set		
<input type="checkbox"/> Size 1 (93 01 001)	357 €	
<input type="checkbox"/> Size 2 (93 02 001)	357 €	

Split footplates – adjustable in height and width, swing away, knee angle adjustable, with calf plates



Especially suitable for users with windsweeping

	Size 1	Size 2
Lower leg length (base plate to footrest)	16 - 28 cm	26 - 38 cm
recommended for lower leg length	24 - 36 cm	34 - 46 cm
Min. width	30 cm	36 cm
Adjustable angle	100° - 165°	
Price / set		
<input type="checkbox"/> Size 1 (93 01 002)	430 €	
<input type="checkbox"/> Size 2 (93 02 002)	430 €	

floyd.

Invoice address:
Dispatch address:
 See invoice address

 Order
 Cost estimate

Customer No.: _____

Orderer: _____

Date: _____

Signature: _____

Commission:
The robust seat pan subframe for outside.

- Tilt adjustment of the seat pan via gas pressure spring 300 N
- Adjustable seat depth using depth adjustable back unit
- 1° rear wheel camber
- Back and push grips, angle and height adjustable
- Incl. support head as a base plate for trapezoidal and external adapter, height and seat depth adjustment
- Incl. socket for footplate
- Incl. rear wheels with quick-release axle and drum brake

HMV-No.: 26.99.01.1xxx*
(with 16" rear wheels)

HMV-No.: 26.99.01.3xxx*
(with 20" to 24" rear wheels
and grip ring)



*in process

Basic model

floyd. size 1		floyd. size 2		floyd. size 3	
	Price / piece		Price / piece		Price / piece
<input type="checkbox"/> 77 01 000	2.320 €	<input type="checkbox"/> 77 02 000	2.320 €	<input type="checkbox"/> 77 03 000	2.320 €

Frame colours

Turquoise blue 	Lasurit blue metallic 	White aluminium (silver) 	Dormant Red 	Pure white 	Anthrazit metallic 	Black satin finish 
						
Price	Price	Price	Price	Price	Price	Price
<input type="checkbox"/> 92 00 016 incl.	<input type="checkbox"/> 92 00 010 incl.	<input type="checkbox"/> 92 00 002 incl.	<input type="checkbox"/> 92 00 003 incl.	<input type="checkbox"/> 92 00 100 incl.	<input type="checkbox"/> 92 00 014 incl.	<input type="checkbox"/> 92 00 005 incl.

Dimensions				
		Size 1	Size 2	Size 3
A*	Min. seat height	45 cm	45 cm	45 cm
B	Seat depth	35 - 45 cm	40 - 50 cm	40 - 50 cm
	Seat angle (adjustment range)	30°	30°	30°
C	Width between rear wheels (with clothing guard) = Max. outerwidth of seat pan	45 cm	50 cm	54 cm
D	Frame width at rear (inside)	35 cm	40 cm	44 cm
E	Width of front abduktion (inside)	45 cm	48 cm	52 cm
F	Seat frame width	30 cm	35 cm	35 cm
G**	Total length	70 - 90 cm	73 - 93 cm	73 - 93 cm
H	Total width	65 cm	70 cm	74 cm
	Max. load	120 kg	120 kg	120 kg
	Weight	from 15 kg	from 15 kg	from 15 kg

* Depending on wheel size, seat height adjustable by 8 cm

** Depending on the wheel size



Versions	Push handles / bar	
<p>Assembly of an additional gas pressure spring (300N) for seat angle adjustment recommended from a patient weight of 90 kg incl. seat pan</p> 	<p>Standard push handles</p> 	<p>Push bar</p> 
Upcharge / set	Price / pair	Upcharge / piece
<input type="checkbox"/> 77 00 050 430 €	<input type="checkbox"/> 25 00 001 incl.	<input type="checkbox"/> for size 1 (25 01 002) 152 € <input type="checkbox"/> for size 2+3 (25 02 002) 152 €

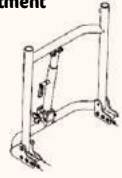
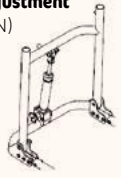

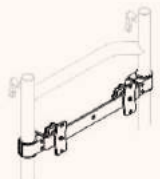
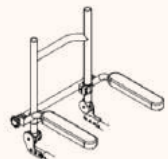
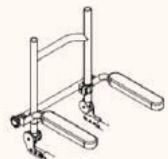
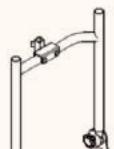
Back			
<p>Back angle adjustment via snap joint</p> 	<p>Centralised fast mechanical adjustment mechanical</p> 	<p>Centralised fast mechanical adjustment via gas pressure spring (300 N)</p> 	
Please note that one of these options must be selected.			
Price / piece	Price / piece	Price / piece	Upcharge / set
<input type="checkbox"/> for size 1 (25 01 003) incl. <input type="checkbox"/> for size 2+3 (25 02 003) incl.	<input type="checkbox"/> for size 1 (25 01 004) incl. <input type="checkbox"/> for size 2+3 (25 02 004) incl.	<input type="checkbox"/> for size 1 (25 01 005) incl. <input type="checkbox"/> for size 2+3 (25 02 005) incl.	95 € 95 €

Accessories			
<p>Back rest support of seat unit</p> 	<p>Armrests – mounted to the back tubes, adjustable width and angle</p> 	<p>Armrests – mounted to the back tubes, adjustable width and folding</p> 	<p>Headrest bracket to mount square tubes (15x15 mm)</p> 
Price / set	Price / set	Price / set	Price / piece
<input type="checkbox"/> for size 1 (25 01 007) 226 € <input type="checkbox"/> for size 2+3 (25 02 007) 226 €	<input type="checkbox"/> for size 1 (25 01 025) 317 € <input type="checkbox"/> for size 2+3 (25 02 025) 317 €	<input type="checkbox"/> for size 1 (25 01 026) 317 € <input type="checkbox"/> for size 2+3 (25 02 026) 317 €	<input type="checkbox"/> 25 00 019 97 €



Front wheels

6" front wheels with rubber coat 150 x 30 mm, colour: black (standard configuration, if nothing else stated)	Full rubber front wheels 140 x 40 mm, colour: black	7" front wheels with rubber coat 180 x 45 mm, colour: black	Front wheels – individuell ____ x ____ mm
			
Price / pair	Upcharge / pair	Upcharge / pair	Price / pair
<input type="checkbox"/> Inflated tyres (25 00 021) incl. <input type="checkbox"/> Puncture-resistant (25 00 022) incl.	<input type="checkbox"/> 25 01 022 43 €	<input type="checkbox"/> Inflated tyres (25 01 021) 43 €	<input type="checkbox"/> 25 09 021 on request

Rear wheels

Rear wheels with inflated tyres – with quick-release axle and drum brake, colour: black	Puncture-resistant rear wheels with quick-release axle and drum brake, colour: black	Clothing guard – fixed	Clothing guard – removable
			
(16" rear wheels only together with 6" front wheels)	(16" rear wheels only together with 6" front wheels)		
Upcharge / set	Upcharge / set	Price / pair	Price / pair
<input type="checkbox"/> 16" (77 00 008) incl. <input type="checkbox"/> 20" (25 01 008) incl. <input type="checkbox"/> 22" (25 02 008) incl. <input type="checkbox"/> 24" (25 03 008) 107 €	<input type="checkbox"/> 16" (77 00 009) incl. <input type="checkbox"/> 20" (25 01 009) incl. <input type="checkbox"/> 22" (25 02 009) incl. <input type="checkbox"/> 24" (25 03 009) 107 €	<input type="checkbox"/> 16" (25 00 011) 232 € <input type="checkbox"/> 20" (25 01 011) 232 € <input type="checkbox"/> 22" (25 02 011) 232 € <input type="checkbox"/> 24" (25 03 011) 232 €	<input type="checkbox"/> 16" (25 00 018) 321 € <input type="checkbox"/> 20" (25 01 018) 321 € <input type="checkbox"/> 22" (25 02 018) 321 € <input type="checkbox"/> 24" (25 03 018) 321 €

Rear wheels

Spoke guard – for rear wheels, transparent	Knee lever brake with bracket	Wheel mount with 3° camber
		
Price / pair	Price / pair	Price / set
<input type="checkbox"/> 20" (25 01 010) 184 € <input type="checkbox"/> 22" (25 02 010) 184 € <input type="checkbox"/> 24" (25 03 010) 184 €	<input type="checkbox"/> 16" (77 00 002) 237 € <input type="checkbox"/> 20" (77 01 002) 237 € <input type="checkbox"/> 22" (77 02 002) 237 € <input type="checkbox"/> 24" (77 03 002) 237 €	<input type="checkbox"/> 77 00 003 75 €

Accessories

Anti tip bar adjustable in height and length, also pivoting (not possible in combination with the bracket for Viamobil / Scalamobil and S-Max)		Tilting device (not possible in combination with the bracket for Viamobil / Scalamobil and S-Max)	
	Price / piece		Price / piece
<input type="checkbox"/> Right attachment (77 01 004) 170 € <input type="checkbox"/> Left attachment (77 02 004) 170 €		<input type="checkbox"/> Right attachment (77 01 005) 75 € <input type="checkbox"/> Left attachment (77 02 005) 75 €	

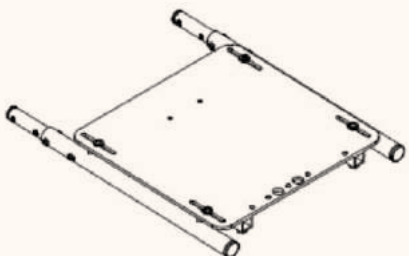
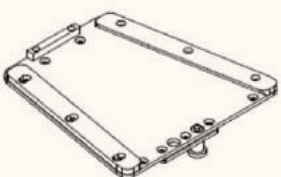
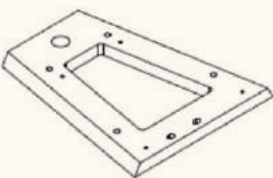
Adapter																									
Support head as a base plate for trapezoidal and external adapters 			Trapezoidal adapter lower part for assembly on the subframe 			Trapezoidal adapter top part for assembly on the seat pan 																			
			<table border="1"> <thead> <tr> <th></th> <th>Length</th> <th>Front width</th> <th>Rear width</th> </tr> </thead> <tbody> <tr> <td>Size 1</td> <td>26 cm</td> <td>26 cm</td> <td>17,5 cm</td> </tr> </tbody> </table>				Length	Front width	Rear width	Size 1	26 cm	26 cm	17,5 cm	<table border="1"> <thead> <tr> <th></th> <th>Length</th> <th>Front width</th> <th>Rear width</th> </tr> </thead> <tbody> <tr> <td>Size 1</td> <td>25 cm</td> <td>21,5 cm</td> <td>12,7 cm</td> </tr> </tbody> </table>					Length	Front width	Rear width	Size 1	25 cm	21,5 cm	12,7 cm
	Length	Front width	Rear width																						
Size 1	26 cm	26 cm	17,5 cm																						
	Length	Front width	Rear width																						
Size 1	25 cm	21,5 cm	12,7 cm																						
Price / piece			Price / piece			Price / piece																			
<input type="checkbox"/> for size 1 (7701016) <input type="checkbox"/> for size 2+3 (7702016)			<input type="checkbox"/> Size 1 (7701034)			<input type="checkbox"/> Size 1 (7701035)																			
incl. incl.			179 €			117 €																			

Assembly set		Retainer systems					
Assembly set for supporting large seat pans on the seat frame for sizes 2+3 <table border="1"> <tr> <td>empfohlene Seat depth</td> <td>> 40 cm</td> </tr> <tr> <td>empfohlene Seat width</td> <td>> 40 cm</td> </tr> </table>		empfohlene Seat depth	> 40 cm	empfohlene Seat width	> 40 cm	Power junction system – to transport the chassis by car (tested according to ISO 7176/19) as an assembly set Securing eyes – to transport the chassis in the car, incl. mounting to the chassis, universally combinable e.g. with systems of Q-Straint, etc. (tested according to ISO 7176/19)	
empfohlene Seat depth	> 40 cm						
empfohlene Seat width	> 40 cm						
Price / set		Net price (not discountable) / set					
<input type="checkbox"/> 7702033 93 €		<input type="checkbox"/> 7700030 362 €					
		<input type="checkbox"/> 7700033 176 €					

Retainer systems		
Bracket for Viamobil / Scalamobil as an assembly set - Only possible with use of the „back angle“ adjustment with snap joints - please use accessories from Alber (anti tip bar, tilting device)	Bracket for S-Max as an assembly set - only possible with use of the „backangle adjustment with snap joints“ - please use accessories from Alber (anti tip bar, tilting device)	Assemble the select bracket at Schuchmann
Net price (not discountable) / set	Net price (not discountable) / set	Net price (not discountable)
<input type="checkbox"/> 7700031 284 €	<input type="checkbox"/> 7700032 284 €	<input type="checkbox"/> 2501030 138 €

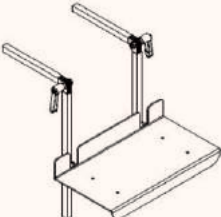
Footplate for subframes		Accessories																	
Aluminium Footplate – with heel edge, height and knee angle adjustment 		Aluminium Footplate – with heel edge, height, knee and foot angle adjustment, also folding 																	
<table border="1"> <thead> <tr> <th></th> <th>Width</th> </tr> </thead> <tbody> <tr> <td>Size 1</td> <td>26 cm</td> </tr> <tr> <td>Size 2</td> <td>30 cm</td> </tr> <tr> <td>Size 3</td> <td>36 cm</td> </tr> </tbody> </table>			Width	Size 1	26 cm	Size 2	30 cm	Size 3	36 cm	<table border="1"> <thead> <tr> <th></th> <th>Width</th> </tr> </thead> <tbody> <tr> <td>Size 1</td> <td>28 cm</td> </tr> <tr> <td>Size 2</td> <td>34 cm</td> </tr> <tr> <td>Size 3</td> <td>40 cm</td> </tr> </tbody> </table>			Width	Size 1	28 cm	Size 2	34 cm	Size 3	40 cm
	Width																		
Size 1	26 cm																		
Size 2	30 cm																		
Size 3	36 cm																		
	Width																		
Size 1	28 cm																		
Size 2	34 cm																		
Size 3	40 cm																		
Price / piece		Price / piece																	
<input type="checkbox"/> Size 1 (7701036) 220 € <input type="checkbox"/> Size 2 (7702036) 220 € <input type="checkbox"/> Size 3 (7703036) 220 €		<input type="checkbox"/> Size 1 (7701037) 290 € <input type="checkbox"/> Size 2 (7702037) 290 € <input type="checkbox"/> Size 3 (7703037) 290 €																	
		Upcharge / set <input type="checkbox"/> 7700038 100 €																	

fridolin 1.

Invoice address:**Dispatch address:**
 See invoice address

 Order
 Cost estimate

Customer No.: _____

Orderer: _____

Date: _____

Signature: _____

Commission:**The functional subframe for indoor.**

- Tilt adjustment of the seat unit via gas pressure spring 500N
- Mechanical height adjustment
- 4 castors (75 mm), 2 with locking devices
- Incl. positioner head for trapezoidal and external adapter and socket for footplate



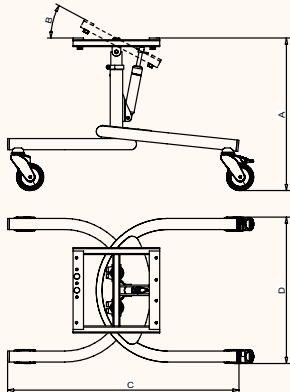

HMV-No.: 26.99.01.0032



Dimensions - basic model

		Size 1	Size 2	
A	Height of seat pan support	41 - 53 cm	41 - 53 cm	
B	Tilt-in-space	(-) 5° - 35°	(-) 5° - 35°	
C	Total length	66 cm	77 cm	
D	Total width	43 cm	51 cm	
	Max. load	50 kg	50 kg	
	Weight	7 kg	8 kg	



Basic model



fridolin 1. size 1		fridolin 1. size 2	
	Price / piece		Price / piece
<input type="checkbox"/> 26 01 000	639 €	<input type="checkbox"/> 26 02 000	660 €

Frame colours					
Lasurit blue metallic		White aluminium (silver) Subframes in this colour available from stock		Dormant Red	
					
					
	Price		Price		Price
<input type="checkbox"/> 92 00 010	incl.	<input type="checkbox"/> 92 00 002	incl.	<input type="checkbox"/> 92 00 003	incl.
				<input type="checkbox"/> 92 00 100	incl.
				<input type="checkbox"/> 92 00 014	incl.

Push bar / handle			
Push bar – angle adjustment, mounted on the support head	Push handle – height and angle adjustment, mounted on the base frame		
			
	Price / piece		Price / piece
<input type="checkbox"/> mounted on support head size 0	(26 00 002)	216 €	<input type="checkbox"/> for size 1
<input type="checkbox"/> mounted on support head size 1	(26 01 002)	216 €	<input type="checkbox"/> for size 2
			(22 01 002)
			(22 02 002)
			295 €
			295 €

Seat angle adjustment		
Trigger lever – mounted directly on the gas pressure spring (standard configuration, if nothing else stated)	Trigger lever – mounted on the push bar / handle	Trigger lever – with fixing plate for assembly to the back of the seat pan
		
Price / piece	Price / piece	Upcharge / piece
<input type="checkbox"/> 26 00 005	incl.	<input type="checkbox"/> 26 00 105
		31 €
		<input type="checkbox"/> 26 00 205
		51 €

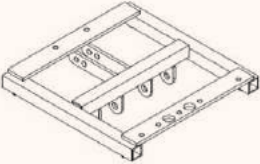
Castors			
4 Castors 2 with locking devices	4 Castors all with locking devices	Wheel base extension insertable, inserts at rear, Length = 10 cm (not possible together with central parking brake)	Central parking brake for rear castors incl. 4 dual castors (100 mm), operated by using the brake lever which is mounted to the seat system (not possible together with the push handle)
			
Upcharge / set	Upcharge / set	Price / set	Price / set
<input type="checkbox"/> 75 mm	(22 04 075)	incl.	<input type="checkbox"/> for size 1
<input type="checkbox"/> 100 mm	(22 04 100)	52 €	<input type="checkbox"/> for size 2
<input type="checkbox"/> 125 mm	(22 04 125)	83 €	<input type="checkbox"/> 22 01 005
		<input type="checkbox"/> 75 mm	381 €
		<input type="checkbox"/> 100 mm	31 €
		<input type="checkbox"/> 125 mm	83 €
		<input type="checkbox"/> 22 06 075	151 €
		<input type="checkbox"/> 22 06 100	151 €
		<input type="checkbox"/> 22 06 125	412 €
			114 €

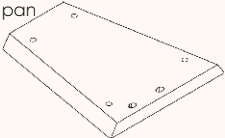
Adapter								
Support head size 0 – for trapezoidal adapter size 0 and external adapter	Trapezoidal adapter lower part size 0 – for assembly on the subframe			Trapezoidal adapter top part size 0 – for assembly on the seat pan				
								
	Length	Front width	Rear width		Length	Front width	Rear width	
	Size 0	20 cm	21 cm	14.5 cm	Size 0	19 cm	16.5 cm	9.8 cm
Price / piece	Price / piece			Price / piece				
<input type="checkbox"/> 26 00 003	incl.	<input type="checkbox"/> 22 00 034	179 €	<input type="checkbox"/> 22 00 035	117 €			

Adapter

Support head size 1 – for trapezoidal adapter size 1 and external adapter

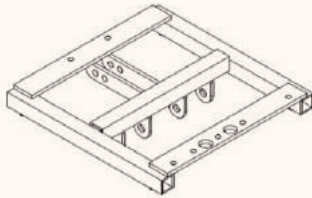

Trapezoidal adapter lower part size 1 – for assembly on the subframe

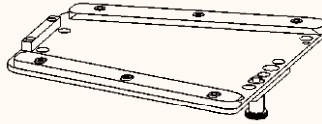

Trapezoidal adapter top part size 1 – assembly on the seat pan



	Length	Front width	Rear width		Length	Front width	Rear width	
Size 1	26 cm	26 cm	17.5 cm	Size 1	25 cm	21.5 cm	12.7 cm	
Price / piece		Price / piece		Price / piece		Price / piece		
<input type="checkbox"/> 26 01 003	incl.		<input type="checkbox"/> 22 01 034	179 €	<input type="checkbox"/> 22 01 035			117 €

Footplate for subframes

Aluminium footplate – for support head size 0, height, knee and foot angle adjustment, also folding

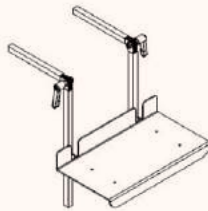

	Width
Size 1	26 cm
Size 2	30 cm

Aluminium footplate – with heel edge for support head size 1, height and knee angle adjustment

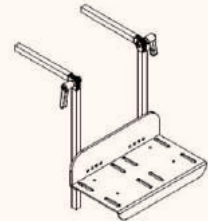

	Width
Size 1	26 cm
Size 2	30 cm
Size 3	36 cm

Price / piece		Price / piece		Price / piece	
<input type="checkbox"/> Size 1 (22 01 037)	290 €	<input type="checkbox"/> Size 1 (22 01 036)	220 €		
<input type="checkbox"/> Size 2 (22 02 037)	290 €	<input type="checkbox"/> Size 2 (22 02 036)	220 €		
		<input type="checkbox"/> Size 3 (22 03 036)	220 €		

Footplate for subframes

Aluminium footplate – for support head size 1, height, knee and foot angle adjustment, also folding

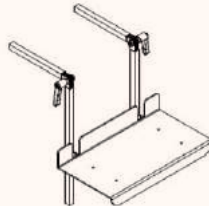

	Width
Size 1	28 cm
Size 2	34 cm
Size 3	40 cm

Accessories

Knee angle adjustment with snap joints – for adjacent footplates, to strengthen the knee-angle locking, material = stainless steel

Price / piece		Upcharge / set	
<input type="checkbox"/> Size 1 (22 01 038)	290 €	<input type="checkbox"/> 22 00 039	100 €
<input type="checkbox"/> Size 2 (22 02 038)	290 €		
<input type="checkbox"/> Size 3 (22 03 038)	290 €		



momo motion.

The tried-and-tested tricycle with E-drive.

Further information can be found from page 104.



fridolin 2.

Invoice address:**Dispatch address:**
 See invoice address

 Order
 Cost estimate

Customer No.: _____

Orderer: _____

Date: _____

Signature: _____

Commission:**The functional subframe for indoors.**

- Tilt adjustment of the seat unit via gas pressure spring 500 N
- Height adjustment via gas pressure spring
- 4 castors (75 mm), 2 with locking devices
- Incl. positioner head for trapezoidal and external adapter and socket for footplate





HMV-No.: 26.99.01.0032

Dimensions - basic model

		Size 1	Size 2	
A	Height of seat pan support	41 - 53 cm	41 - 53 cm	
B	Tilt-in-space	(-) 5° - 35°	(-) 5° - 35°	
C	Total length	66 cm	77 cm	
D	Total width	45 cm	53 cm	
	Strength of the gas pressure spring for height adjustment	250 N	350 N	
	Max. load	50 kg	50 kg	
	Weight	7 kg	8 kg	



Basic model



fridolin 2. size 1		fridolin 2. size 2	
	Price / piece		Price / piece
<input type="checkbox"/> 2201001	725 €	<input type="checkbox"/> 2202000	752 €

Frame colours					
Lasurit blue metallic		White aluminium (silver) Subframes in this colour available from stock		Dormant Red	
					
					
	Price		Price		Price
<input type="checkbox"/> 92 00 010	incl.	<input type="checkbox"/> 92 00 002	incl.	<input type="checkbox"/> 92 00 003	incl.
				<input type="checkbox"/> 92 00 100	incl.
				<input type="checkbox"/> 92 00 014	incl.

Push bar / handle			
Push bar – angle adjustment, mounted on the support head	Push handle – height and angle adjustment, mounted on the base frame		
			
	Price / piece		Price / piece
<input type="checkbox"/> mounted on support head size 0 (26 00 002)	216 €	<input type="checkbox"/> for size 1 (22 01 002)	295 €
<input type="checkbox"/> mounted on support head size 1 (26 01 002)	216 €	<input type="checkbox"/> for size 2 (22 02 002)	295 €

Seat angle adjustment		
Trigger lever – mounted directly on the gas pressure spring (standard configuration, if nothing else stated)	Trigger lever – mounted on the push bar/handle	Trigger lever – with fixing plate for assembly to the back of the seat pan
		
	Price / piece	Upcharge / piece
<input type="checkbox"/> 26 00 005	incl.	<input type="checkbox"/> 26 00 105
		31 €
		<input type="checkbox"/> 26 00 205
		51 €

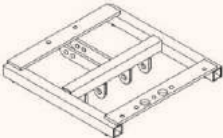
Castors			
4 Castors – 2 with locking devices	4 Castors – all with locking devices	Wheel base extension insertable, inserts at rear, length = 10 cm (not possible together with central parking brake)	Central parking brake for rear castors incl. 4 dual castors (100 mm), operated by using the brake lever which is mounted to the seat system (not possible together with the push handle)
			
	Upcharge / set	Price / set	Price / set
<input type="checkbox"/> 75 mm (22 04 075)	incl.	<input type="checkbox"/> for size 1 (22 01 006)	151 €
<input type="checkbox"/> 100 mm (22 04 100)	52 €	<input type="checkbox"/> for size 2 (22 02 006)	151 €
<input type="checkbox"/> 125 mm (22 04 125)	83 €	<input type="checkbox"/> 22 01 005	381 €
		<input type="checkbox"/> 22 01 105 front castors with locking devices	412 €
		<input type="checkbox"/> 75 mm (22 06 075)	31 €
		<input type="checkbox"/> 100 mm (22 06 100)	83 €
		<input type="checkbox"/> 125 mm (22 06 125)	114 €

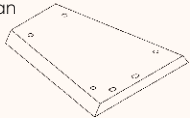
Adapter								
Support head size 0 – for trapezoidal adapter size 0 and external adapter	Trapezoidal adapter lower part size 0 – for assembly on the subframe			Trapezoidal adapter top part size 0 – for assembly on the seat pan				
								
	Length	Front width	Rear width		Length	Front width	Rear width	
	Size 0	20 cm	21 cm	14.5 cm	Size 0	19 cm	16.5 cm	98 cm
	Price / piece	Price / piece			Price / piece			
<input type="checkbox"/> 22 02 003	incl.	<input type="checkbox"/> 22 00 034	179 €			<input type="checkbox"/> 22 00 035	117 €	

Adapter

Support head size 1 – for trapezoidal adapter size 1 and external adapter

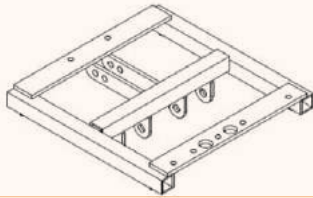

Trapezoidal adapter lower part size 1 for assembly on the subframe

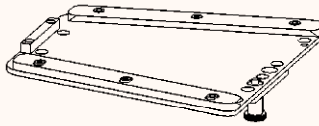

Trapezoidal adapter top part size 1 for assembly on the seat pan



	Length	Front width	Rear width
Size 1	26 cm	26 cm	17.5 cm

	Length	Front width	Rear width
Size 1	25 cm	21.5 cm	12.7 cm

Price / piece

Price / piece

Price / piece

22 00 003

incl.

22 01 034

179 €

22 01 035

117 €

Footplate for subframes

Aluminium footplate – for support head size 0, height, knee and foot angle adjustment, also folding

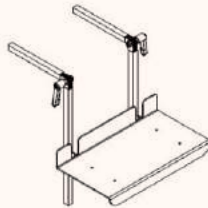

	Width
Size 1	26 cm
Size 2	30 cm

Price / piece

- Size 1 (**22 01 037**)
- Size 2 (**22 02 037**)

290 €
290 €

Aluminium footplate – with heel edge for support head size 1, height and knee angle adjustment

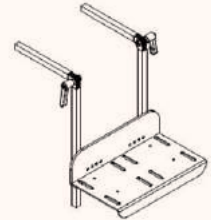

	Width
Size 1	26 cm
Size 2	30 cm
Size 3	36 cm

Price / piece

- Size 1 (**22 01 036**)
- Size 2 (**22 02 036**)
- Size 3 (**22 03 036**)

220 €
220 €
220 €

Footplate for subframes

Aluminium footplate – for support head size 0, height, knee and foot angle adjustment, also folding

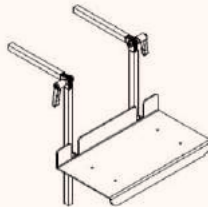

	Width
Size 1	28 cm
Size 2	34 cm
Size 3	40 cm

Price / piece

- Size 1 (**22 01 038**)
- Size 2 (**22 02 038**)
- Size 3 (**22 03 038**)

290 €
290 €
290 €

Accessories

Knee angle adjustment with snap joints – with heel edge for support head size 1, height and knee angle adjustment

- 22 00 039**

Upcharge / set

100 €



hts.

The universal toilet seat system.

Further information can be found from page 142.



fridolin maxi.

Invoice address:
Dispatch address:
 See invoice address

 Order
 Cost estimate

Customer No.: _____

Orderer: _____

Date: _____

Signature: _____

Commission:
The functional subframe for indoors.

- The seat height is adjustable using a crank
- The angular adjustment of the seat unit can be operated through two gas pressure springs à 200 N via a foot pedal
- Incl. 4 dual castors (100 mm), 2 with locking devices
- Incl. support head and plug-in footplate
- Frame colour: anthracite metallic
- Max. load: 100 kg

HMV-No.: 26.99.01.0032

Dimensions - basic model

A	Height of seat pan support	44 - 56 cm
B	Tilt-in-space	(-) 5° - 30°
C	Total length	80 cm
D	Total width	66 cm
	Strength of gas pressure spring for tilt adjustment	2x200 N
	Max. load	100 kg
	Weight	11.5 kg

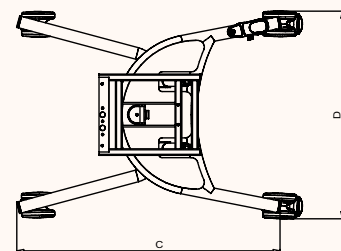
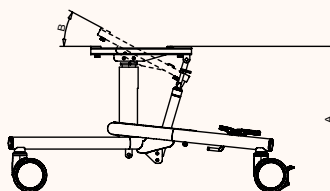

Basic model

Price / piece

 22 03 000

1.136 €

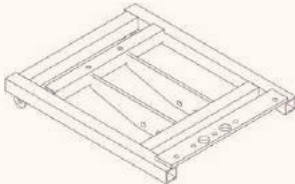
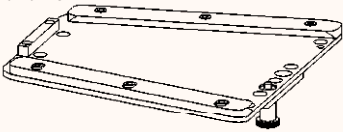
Push handle		Wheel base extension	
<p>Maxi push handle Height and angle adjustment</p> 		<p>Wheel base extension – insertable, inserts at rear, Length = 10 cm</p> 	
	Price / piece		Price / set
<input type="checkbox"/> 22 03 002	303 €	<input type="checkbox"/> 22 03 006	151 €

Adapter								
<p>Maxi support head – for trapezoidal adapter size 1 and external adapter</p> 	<p>Trapezoidal adapter lower part size 1 – for assembly on the subframe</p> 			<p>Trapezoidal adapter top part size 1 – for assembly on the seat pan</p> 				
		Length	Front width	Rear width		Length	Front width	Rear width
	Size 1	26cm	26cm	17.5cm	Size 1	25cm	21.5cm	12.7cm
	Price / piece	Price / piece				Price / piece		
<input type="checkbox"/> 22 03 003	incl.	<input type="checkbox"/> 22 01 034	179 €		<input type="checkbox"/> 22 01 035	117 €		

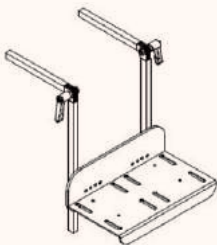
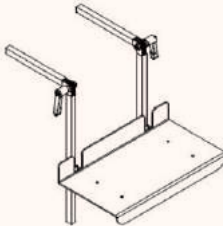
Footplate for subframes				Accessories	
<p>Aluminium footplate with heel edge for support head size 1, height and knee angle adjustment</p>		<p>Aluminium footplate for support head size 1, height, knee and foot angle adjustable, also folding</p>		<p>Knee angle adjustment with snap joints for adjacent footplates, to strengthen the knee-angle locking, material = stainless steel</p>	
	Width				
Size 1	26cm				
Size 2	30cm				
Size 3	36cm				
	Price / piece	Price / piece		Upcharge / set	
<input type="checkbox"/> Size 1 (22 01 036)	220 €	<input type="checkbox"/> Size 1 (22 01 038)	290 €	<input type="checkbox"/> 22 00 039 100 €	
<input type="checkbox"/> Size 2 (22 02 036)	220 €	<input type="checkbox"/> Size 2 (22 01 038)	290 €		
<input type="checkbox"/> Size 3 (22 03 036)	220 €	<input type="checkbox"/> Size 3 (22 01 038)	290 €		

Footplate for subframes	
<p>Plug-on footplate – height approx. 8 cm above the floor</p> 	
	Price / piece
<input type="checkbox"/> 22 03 004	311 €

Invoice address:**Dispatch address:**
 See invoice address

 Order
 Cost estimate

Customer No.: _____

Orderer: _____

Date: _____

Signature: _____



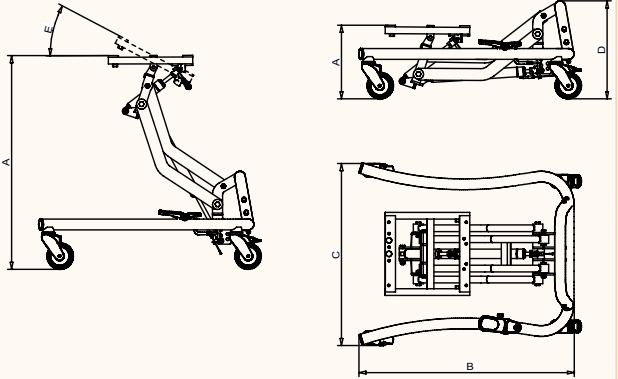

Commission:**The universal subframe.**

- Tilt adjustment of the seat pan via gas pressure spring 500 N
- Height adjustment via gas pressure spring 1200 N (800 N for size 0)
- 4 castors (75 mm), 2 with locking devices
- Incl. positioner head for trapezoidal and external adapter and foot rest insertion und Footplateeinsteckung

HMV-No.: 26.99.01.0022
**Dimensions - basic model**



		Size 0	Size 1	Size 2	
A	Height of seat pan support	18 - 55 cm	18 - 55 cm	18 - 55 cm	
	Height of seat pan support with electric height adjustment	26 - 55 cm	26 - 55 cm	26 - 55 cm	
	Height of seat pan support with hydraulic height adjustment	20 - 56 cm	20 - 56 cm	20 - 56 cm	
	Height of seat pan support with combi subframe	-	25 - 64 cm	25 - 64 cm	
B	Total length	58 cm	61 cm	75 cm	
	Total length with combi subframe	71 cm	76 cm	86 cm	
C	Total width	52 cm	54 cm	64 cm	
	Total width with combi subframe	62 cm	66 cm	76 cm	
D	Frame height	27 cm	27 cm	27 cm	
E	Tilt-in-space	(-)5° - 35°	(-)5° - 35°	(-)5° - 35°	
	Max. load	30 kg	50 kg	75 kg	
	Weight	8 kg	10 kg	12 kg	

Basic model		
franka. size 0	franka. size 1	franka. size 2
Price / piece	Price / piece	Price / piece
<input type="checkbox"/> 21 00 000 1.098 €	<input type="checkbox"/> 21 01 000 1.198 €	<input type="checkbox"/> 21 02 000 1.248 €

Frame colours					
Lasurit blue metallic 	White aluminium (silver)  Subframes in this colour available from stock	Dormant Red 	Pure white 	Anthracit metallic  Subframes in this colour available from stock	
Price	Price	Price	Price	Price	Price
<input type="checkbox"/> 92 00 010 incl.	<input type="checkbox"/> 92 00 002 incl.	<input type="checkbox"/> 92 00 003 incl.	<input type="checkbox"/> 92 00 100 incl.	<input type="checkbox"/> 92 00 014 incl.	

Push bar / handle		Accessories	
Push bar – angle adjustment, mounted on the support head 	Push handle – height and angle adjustment (mounted on the base frame) 	Anti tip – adjustable in height 	Wheel base extension pluggable, mounted in the front, length = 10 cm 
Price / piece	Price / piece	Price / piece	Price / set
<input type="checkbox"/> for support head size 0 (21 00 013) 216 € <input type="checkbox"/> for support head size 1 (21 01 013) 216 €	<input type="checkbox"/> for size 0+1 (21 00 001) 295 € <input type="checkbox"/> for size 2 (21 00 201) 295 €	<input type="checkbox"/> 21 00 009 (for stand. & electric height adjustment) 230 € <input type="checkbox"/> 21 00 109 (for hydr. height adjustment) 230 €	<input type="checkbox"/> 21 00 209 151 €

Seat angle adjustment		
Trigger lever – mounted directly on the gas pressure spring (standard configuration, if nothing else stated) 	Trigger lever – mounted on the push bar/handle 	Trigger lever – with fixing plate for assembly to the back of the seat pan 
Price / piece	Price / piece	Upcharge / piece
<input type="checkbox"/> 21 00 002 incl.	<input type="checkbox"/> 21 00 014 31 €	<input type="checkbox"/> 21 00 015 51 €

Accessories							
Conversion kit for combi subframe with 12 1/2" wheels, screw-in axles, drum brake, steering wheels 6° and push handle 	Hydraulic height adjustment retrofitting not possible! <small>(not possible together with the conversion kit for combi subframe or electric height adjustment)</small> 	Electric height adjustment by a 24-volt electric motor 	Additional gas dampers (2 pcs) to support the lift function <small>(not possible in combination with the hydraulic or electric height adjustment!)</small> <table border="1"> <tr> <td>2x 300 N</td> <td>Recommended from 30 kg load</td> </tr> <tr> <td>2x 500 N</td> <td>Recommended from 40 kg load</td> </tr> </table>	2x 300 N	Recommended from 30 kg load	2x 500 N	Recommended from 40 kg load
2x 300 N	Recommended from 30 kg load						
2x 500 N	Recommended from 40 kg load						
Price / set	Upcharge / set	Price / set	Price / set				
<input type="checkbox"/> for size 0 (21 00 101) 765 € <input type="checkbox"/> for size 1 (21 01 001) 765 € <input type="checkbox"/> for size 2 (21 02 001) 765 €	<input type="checkbox"/> for size 1 (21 01 050) 460 € <input type="checkbox"/> for size 2 (21 02 050) 460 €	<input type="checkbox"/> 21 00 007 805 €	<input type="checkbox"/> 2x 300 N (21 00 005) 107 € <input type="checkbox"/> 2x 500 N (21 00 006) 107 €				

Castors

4 Castors – 2 with locking devices
(125 mm not possible for size 0)

4 Castors – all with locking devices
(125 mm not possible for size 0)

Upcharge / set

Upcharge / set

 75 mm **(21 04 075)**
 100 mm **(21 04 100)**
 125 mm **(21 04 125)**

 incl.
52 €
83 €

 75 mm **(21 06 075)**
 100 mm **(21 06 100)**
 125 mm **(21 06 125)**

 31 €
83 €
114 €

Central parking brake
Central parking brake for rear castors

incl. 4 dual castors (100 mm), operated by using the brake lever which is mounted to the seat system

Central parking brake for rear castors

 incl. 4 dual castors (100 mm), **front with locking devices**, operated by using the brake lever which is mounted to the seat system

Price / set

Price / set

 for size 0 **(2100011)**
 for size 1 **(2101011)**
 for size 2 **(2102011)**

 381 €
381 €
381 €

 for size 0 **(2100 111)**
 for size 1 **(2101 111)**
 for size 2 **(2102 111)**

 412 €
412 €
412 €

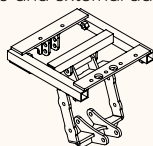
Adapter
Support head size 0 – for trapezoidal adapter size 0 and external adapter

Trapezoidal adapter lower part size 0 – for assembly on the subframe

Trapezoidal adapter top part size 0 – for assembly on the seat pan

	Length	Front width	Rear width
Size 0	20 cm	21 cm	14.5 cm

	Length	Front width	Rear width
Size 0	19 cm	16.5 cm	9.8 cm

Price / piece

Price / piece

Price / piece

 2102 003

incl.

 2100 016

179 €

 2100 017

117 €

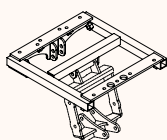
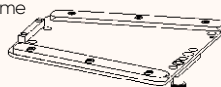
Adapter
Support head size 1 – for trapezoidal adapter size 1 and external adapter

Trapezoidal adapter lower part size 1 – for assembly on the subframe

Trapezoidal adapter top part size 1 – for assembly on the seat pan

	Length	Front width	Rear width
Size 1	26 cm	26 cm	17.5 cm

	Length	Front width	Rear width
Size 1	25 cm	21.5 cm	12.7 cm

Price / piece

Price / piece

Price / piece

 2100 003

incl.

 2101 016

179 €

 2101 017

117 €

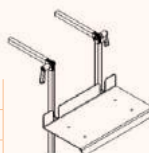
Footplate for subframes
Aluminium footplate – for support head size 0, height, knee and foot angle adjustable, also folding

	Width
Size 1	26 cm
Size 2	30 cm

Price / piece

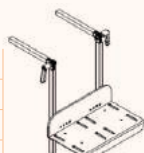
Aluminium footplate – with heel edge for support head size 1, height and knee angle adjustment

	Width
Size 1	26 cm
Size 2	30 cm
Size 3	36 cm

Price / piece

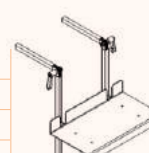
Aluminium footplate – for support head size 1, height, knee and foot angle adjustable, also folding

	Width
Size 1	28 cm
Size 2	34 cm
Size 3	40 cm

Price / set

Accessories
Knee angle adjustment with snap joints – for adjacent footplates, to strengthen the knee-angle locking, material = stainless steel

 Size 1 **(2101019)** 290 €
 Size 2 **(2102019)** 290 €

 Size 1 **(2101018)** 220 €
 Size 2 **(2102018)** 220 €
 Size 3 **(2103018)** 220 €

 Size 1 **(2101020)** 290 €
 Size 2 **(2102020)** 290 €
 Size 3 **(2103020)** 290 €

 2100021 100 €



todd.

The sporty and agile standing frame.

Further information can be found from page 126.



tom 5 streeter.

Invoice address:

Dispatch address: See invoice address

Order
 Cost estimate

Customer No.: _____
 Orderer: _____
 Date: _____
 Signature: _____

Commission:

The rehab buggy that grows with you.

- Tested according to the requirements of EN ISO 7176/19
- Foldable frame with seat unit
- Frame (with springs) and with foot brake
- Steerable front wheels with direction locks
- Multifunctional, removable and rotating seat unit in 3 sizes
- Adjustable seat depth, seat width and back height
- Infinitely adjustable seat tilt
- Fold-up, knee-angle and height-adjustable footplate
- Removable, padded headband
- Boundary pads
- Cover: Black / white
- Frame: white
- Tires: Puncture-resistant



HMV-No.: 18.99.01.2071

Basic model					
tom 5 streeter. size 1		tom 5 streeter. size 2		tom 5 streeter. size 3	
Price / piece		Price / piece		Price / piece	
<input type="checkbox"/> 28 01 000 / BW	2.591 €	<input type="checkbox"/> 28 02 000 / BW	2.591 €	<input type="checkbox"/> 28 03 000 / BW	2.695 €

Dimensions - basic model

		Size 1	Size 2	Size 3
A	Backrest height	44 - 57 cm	51 - 68 cm	55 - 70 cm
B	Seat depth	21 - 27 cm	23 - 33 cm	29 - 40 cm
C	Seat width	22 - 28 cm	25 - 35 cm	27 - 39 cm
D	Lower leg length	9 - 26 cm	12 - 36 cm	12 - 39 cm
	Backrest angle	0° - 175°	0° - 175°	0° - 175°
	Seat tilt in direction of travel	(-)28° - 45°	(-)26° - 40°	(-)26° - 40°
E	Total length	76 cm	76 cm	76 cm
F	Total width	59 cm	63 cm	67 cm
G	Total height (with adjustable push handle)	85 / 110 cm	90 / 115 cm	90 / 115 cm
	Weight	15,5 kg	17,5 kg	19 kg
	Max. load	35 kg	40 kg	50 kg
	Length (folded)	90 cm	92 cm	95 cm
	Width (folded)	59 cm	63 cm	67 cm
	Height (folded)	36 cm	37 cm	37 cm

Accessories
Headrest

Price / piece

<input type="checkbox"/> Size 1 (28 01 002)	193 €
<input type="checkbox"/> Size 2 (28 02 002)	193 €

Lateral pads

Price / pair

<input type="checkbox"/> Size 1 (28 01 003)	198 €
<input type="checkbox"/> Size 2 (28 02 003)	198 €

Pelvic harness

Price / piece

<input type="checkbox"/> Size 1 (28 01 004)	74 €
<input type="checkbox"/> Size 2 (28 02 004)	74 €

Accessories
4-point pelvic harness

Price / piece

<input type="checkbox"/> Size 1 (28 01 005)	144 €
<input type="checkbox"/> Size 2 (28 02 005)	144 €

5-point harness

Price / piece

<input type="checkbox"/> Size 1 (28 01 006)	158 €
<input type="checkbox"/> Size 2 (28 02 006)	158 €

Groin harness

Price / piece

<input type="checkbox"/> Size 1 (28 01 007)	126 €
<input type="checkbox"/> Size 2 (28 02 007)	126 €
<input type="checkbox"/> Size 3 (28 03 007)	126 €

Accessories

Chest-shoulder strap	Positioning jacket	Abductor wedge
		
Price / piece	Price / piece	Price / piece
<input type="checkbox"/> Size 1 (28 01 008) 115 €	<input type="checkbox"/> Size 1 (28 01 009) 140 €	<input type="checkbox"/> Size 1 (28 01 010) 133 €
<input type="checkbox"/> Size 2 (28 02 008) 115 €	<input type="checkbox"/> Size 2 (28 02 009) 140 €	<input type="checkbox"/> Size 2 (28 02 010) 133 €
<input type="checkbox"/> Size 3 (28 03 008) 115 €	<input type="checkbox"/> Size 3 (28 03 009) 140 €	<input type="checkbox"/> Size 3 (28 03 010) 133 €

Accessories

Therapy tray – made of wood with edge	Storage basket – for all sizes	Support plate for supply units
		
Price / piece	Price / piece	Price / piece
<input type="checkbox"/> for size 1 (28 01 021) 253 €	<input type="checkbox"/> 28 02 011 86 €	<input type="checkbox"/> for size 1 (28 01 012) 352 €
<input type="checkbox"/> for size 2 (28 02 021) 253 €		<input type="checkbox"/> for size 2+3 (28 02 012) 352 €
<input type="checkbox"/> for size 3 (28 03 021) 253 €		



Accessories

Footmuff - Summer	Footmuff - Winter	Extended side protection to be used only in the direction of travel
		
Price / piece	Price / piece	Price / piece
<input type="checkbox"/> for size 1 (28 01 013) 144 €	<input type="checkbox"/> for size 1 (28 01 014) 253 €	<input type="checkbox"/> 28 00 015 224 €
<input type="checkbox"/> for size 2+3 (28 02 013) 144 €	<input type="checkbox"/> for size 2+3 (28 02 014) 253 €	

Accessories

Accessories tote	Caps – for the retaining clip holder	Drum brake – with manual operation
		
Price / piece	Price / set	Price / piece
<input type="checkbox"/> 28 00 018 99 €	<input type="checkbox"/> 28 00 019 42 €	<input type="checkbox"/> 28 03 020 327 €

Accessories

Soft top – with window for accompanying person 	Rain cape – can only be used in conjunction with the soft top 	Combination top – with window for accompanying person, incl. integrated raincape
Price / piece	Price / piece	Price / piece
<input type="checkbox"/> for size 1 (2801016) 176 € <input type="checkbox"/> for size 2+3 (2802016) 176 €	<input type="checkbox"/> for size 1 (2800017) 60 € <input type="checkbox"/> for size 2 (2801017) 60 € <input type="checkbox"/> for size 3 (2802017) 60 €	<input type="checkbox"/> for size 1 (2801022) 309 € <input type="checkbox"/> for size 2+3 (2802022) 309 €



Subframe for individual seating systems

	Frame size 1 (without storage basket) <ul style="list-style-type: none"> • colour: white • incl. bracket for trapezoidal and foreign adapter • with steerable front wheels and directional lock • 265mm rear wheels, puncture-resistant • 175mm front wheels, puncture-resistant 	Frame size 2 (without storage basket) <ul style="list-style-type: none"> • colour: white • incl. bracket for trapezoidal and foreign adapter • with steerable front wheels and directional lock • 265mm rear wheels, puncture-resistant • 175mm front wheels, puncture-resistant 	Frame size 3 (without storage basket) <ul style="list-style-type: none"> • colour: white • incl. bracket for trapezoidal and foreign adapter • with steerable front wheels and directional lock • 265mm rear wheels, puncture-resistant • 175mm front wheels, puncture-resistant
	Price / piece	Price / piece	Price / piece
<input type="checkbox"/> 2801500 1.597 €	<input type="checkbox"/> 2802500 1.597 €	<input type="checkbox"/> 2803500 1.597 €	

Footplate for subframes

Footplate – fold-up, knee-angle and height-adjustable
Price / piece
<input type="checkbox"/> for size 1 (2801023) 482 € <input type="checkbox"/> for size 2 (2802023) 482 € <input type="checkbox"/> for size 3 (2803023) 482 €

Adapter

Trapezoidal adapter lower part size 1 for mounting on the subframe 	Trapezoidal adapter top part size 1 for mounting on the seatpan 																
Price / piece	Price / piece																
<table border="1"> <thead> <tr> <th></th> <th>Length</th> <th>Front width</th> <th>Rear width</th> </tr> </thead> <tbody> <tr> <td>Size 1</td> <td>26cm</td> <td>26cm</td> <td>17.5cm</td> </tr> </tbody> </table>		Length	Front width	Rear width	Size 1	26cm	26cm	17.5cm	<table border="1"> <thead> <tr> <th></th> <th>Length</th> <th>Front width</th> <th>Rear width</th> </tr> </thead> <tbody> <tr> <td>Size 1</td> <td>25cm</td> <td>21.5cm</td> <td>12.7cm</td> </tr> </tbody> </table>		Length	Front width	Rear width	Size 1	25cm	21.5cm	12.7cm
	Length	Front width	Rear width														
Size 1	26cm	26cm	17.5cm														
	Length	Front width	Rear width														
Size 1	25cm	21.5cm	12.7cm														
<input type="checkbox"/> 2801501 179 €	<input type="checkbox"/> 2801502 117 €																

corzo xcountry.

Invoice address:

- Order**
- Cost estimate**

Customer No.: _____

Orderer: _____

Date: _____

Signature: _____

Dispatch address: See invoice address

Commission:

I am your foldable rehab buggy.

- Tested according to the requirements of EN ISO 7176/19
- Steel / aluminum frame with footbrake
- Steerable and puncture-resistant front wheels
- Handles (height adjustable only for sizes 1+2)
- Adjustable seat depth and back height
- Height adjustable, foldable and removable footplate
- 5-point harness with padded crotch strap
- Cover: black
- Frame: anthracite



HMV-No.: 18.99.01.1032



Basic model			
corzo xcountry. size 1	corzo xcountry. size 2	corzo xcountry. size 3	corzo xcountry. size 4
Price / piece	Price / piece	Price / piece	Price / piece
<input type="checkbox"/> 29 01 000 / 1 1.529 €	<input type="checkbox"/> 29 02 000 / 1 1.529 €	<input type="checkbox"/> 29 03 000 / 1 1.696 €	<input type="checkbox"/> 29 04 000 / 1 1.696 €

Dimensions - basic model

		Size 1	Size 2	Size 3	Size 4
A	Backrest height	54 - 57 cm	58 - 67 cm	67 - 93 cm	67 - 93 cm
B	Seat depth	26 - 34 cm	30 - 37 cm	32 - 39 cm	32 - 40 cm
	Seat width	30 cm	34 cm	38 cm	42 cm
C	Lower leg length	24 - 37 cm	28 - 45 cm	29 - 47 cm	33 - 50 cm
	Backrest angle	106° / 111°	110° / 114°	110° / 114°	108° / 112°
	Seat angle	17°	22°	21°	19°
D	Total length	98 cm	103 cm	115 cm	115 cm
	Total width	53 cm	58 cm	63 cm	65 cm
E	Total height (with adjustable handles over for sizes 1+2)	101 - 112 cm	98 - 108 cm	102 - 118 cm	121 - 132 cm
	Weight	12.5 kg	13 kg	14 kg	14.7 kg
	Max. load	45 kg	55 kg	75 kg	75 kg
	Length (folded)	117 cm	117 cm	120 cm	126 cm
	Width (folded)	32 cm	32 cm	35 cm	37 cm
	Height (folded)	35 cm	37 cm	38 cm	35 cm

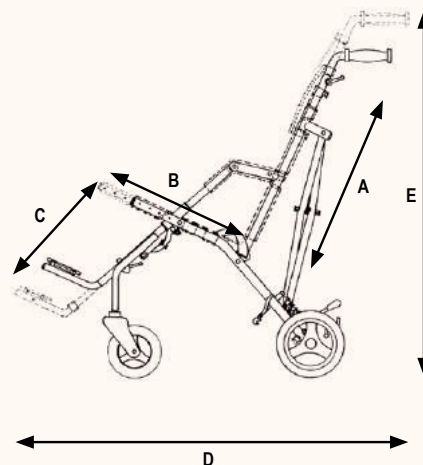



Accessories

Footplate – height adjustable, foldable and removable (standard configuration, if nothing else stated)	Split footplates – height adjustable, foldable and removable	Headrest	Seat padding
			
Please choose either footplate or split footplates.			
Price / piece	Price / piece	Price / piece	Price / piece
<input type="checkbox"/> for size 1 (29 01 001) incl. <input type="checkbox"/> for size 2 (29 02 001) incl. <input type="checkbox"/> for size 3 (29 03 001) incl. <input type="checkbox"/> for size 4 (29 04 001) incl.	<input type="checkbox"/> for size 1 (29 01 002) incl. <input type="checkbox"/> for size 2-4 (29 02 002) incl.	<input type="checkbox"/> 29 00 003 135 €	<input type="checkbox"/> for size 1+2 (29 01 004/1) 208 € <input type="checkbox"/> for size 3+4 (29 02 004/1) 208 €

Accessories

Lateral guide	Chest-shoulder strap	Positioning jacket	Pelvic harness
			
Price / pair	Price / piece	Price / piece	Price / piece
<input type="checkbox"/> for size 1 (29 01 005) 64 € <input type="checkbox"/> for size 2-4 (29 02 005) 64 €	<input type="checkbox"/> 29 00 006 115 €	<input type="checkbox"/> 29 00 007 140 €	<input type="checkbox"/> Size 1 (29 01 008) 74 € <input type="checkbox"/> Size 2 (29 02 008) 74 €

Accessories

Soft top – with window for accompanying person	Rain cape – can only be used in conjunction with the soft top	Basket
		
Price / piece	Price / piece	Price / piece
<input type="checkbox"/> 29 00 009 176 €	<input type="checkbox"/> for size 1+2 (29 01 010) 60 € <input type="checkbox"/> for size 3+4 (29 02 010) 60 €	<input type="checkbox"/> for size 1+2 (29 01 011) 86 € <input type="checkbox"/> for size 3+4 (29 02 011) 86 €

pip.

Invoice address:

Dispatch address: See invoice address

Order
 Cost estimate

Customer No.: _____
 Orderer: _____
 Date: _____
 Signature: _____

Commission:

The comfortable, foldable rehab buggy.

- Light aluminium frame, rear wheels can be locked with a centrally operated brake
- Detachable wheels, front wheels with directional lock can be steered
- Angle-adjustable backrest (90° - 135°)
- Height-adjustable and detachable foot support
- 5-point strap with padded shoulder and crotch strap
- Incl. canopy and storage basket
- Removable covers
- Frame colour: black



HMV-No.: 18.99.01.1052

new
 now
 also in
 black



Basic model		
<p>pip. with black covers</p> 	<p>pip. with blue covers</p> 	<p>pip. with pink covers</p> 
Price / piece	Price / piece	Price / piece
<input type="checkbox"/> 2001000 / 0 1.550 €	<input type="checkbox"/> 2001000 / 1 1.550 €	<input type="checkbox"/> 2001000 / 2 1.550 €

Dimensions - basic model

		piper.
A	Backrest height	68 cm
B	Seat depth	29 cm
C	Seat width	24 - 35 cm
D	Lower leg length	25 - 37,5 cm
	Backrest angle	90° - 135°
	Seat angle	26°
E	Total length	108 cm
F	Total width	59 cm
G	Total height	100 cm
	Weight	14,5 kg
	Max. load	40 kg
	Length (folded)	100 cm
	Width (folded)	31 cm
	Height (folded)	30 cm

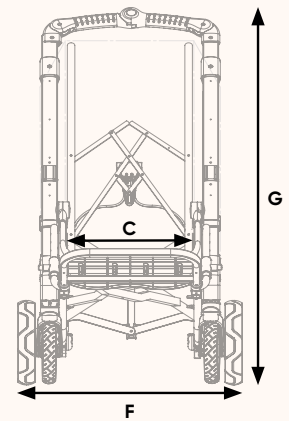
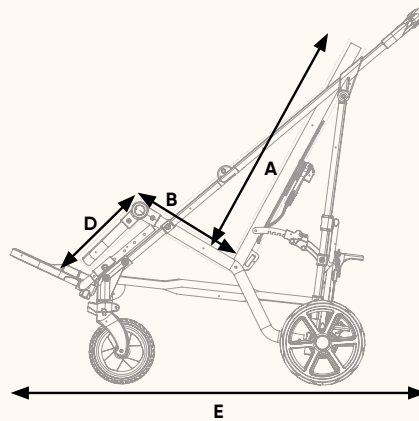
Accessories
Headrest

Price / piece

 20 00 001

135 €

Flexipads set – to be fastened by Velcro

Price / set

 20 00 002

160 €

Seat padding – incl. 4 side padding (velcro) and one back cushion (seat depth is reduced to 23 cm)

Price / set

- Black (20 00 003/0)** 208 €
- Blue (20 00 003/1)** 208 €
- Pink (20 00 003/2)** 208 €

Foot positioner

Price / pair

 20 00 004

67 €

Accessories
Footmuff (summer)

Price / piece

 20 00 005

144 €

Footmuff (winter)

Price / piece

 20 00 006

253 €

Rain cape

Price / piece

 20 00 007

60 €

Invoice address: **Order** **Cost estimate**

Customer No.: _____

Orderer: _____

Date: _____

Signature: _____

Dispatch address: See invoice address**Commission:****The compact and versatile posterior-walker.**



- Lightweight and folding aluminium frame (size 0 cannot be folded)
- Individual height and width adjustable handles
- EVA rear wheels with integrated backwards stop function in the hub, can be switched off
- EVA front wheels with direction locks

HMV-No.: 10.46.02.3029**Dimensions - basic model**

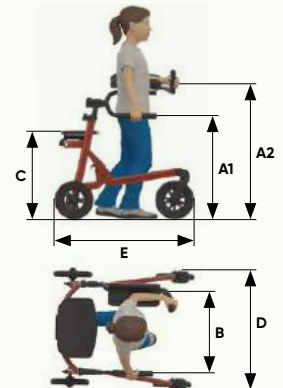

		Size 0 frame cannot be folded	Size 1	Size 2	Size 3	Size 4
A1	Handle height	29 - 53 cm	34 - 58 cm	51 - 75 cm	68 - 94 cm	87 - 113 cm
A2	Height of forearm supports	-	46 - 70 cm	63 - 87 cm	79 - 103 cm	98 - 124 cm
B	Handle spacing	22 - 36 cm	22 - 36 cm	30 - 44 cm	38 - 52 cm	43 - 57 cm
C	Seat height	-	33 cm	45 cm	60 cm	70 cm
D	Total width	52 cm	51 cm	61 cm	68 cm	75 cm
E	Total length	58 cm	58 cm	70 cm	77 cm	87 cm
	Frame height (folded)	37 cm	25 cm	32 cm	34 cm	37 cm
	Transport dimensions (L x W x H)	58x52x37 cm	58x51x25 cm	70x61x32 cm	77x68x34 cm	87x75x37 cm
	Max. load	20 kg	30 kg	50 kg	75 kg	100 kg
	Weight	39 kg	71 kg	8.3 kg	8.5 kg	10.2 kg



Basic model				
malte mini. size 0 Frame colour: Lasurit blue metallic (frame cannot be folded)	malte. size 1	malte. size 2	malte. size 3	malte. size 4
Price / piece	Price / piece	Price / piece	Price / piece	Price / piece
<input type="checkbox"/> 35 00 100 703 €	<input type="checkbox"/> 75 01 000 735 €	<input type="checkbox"/> 75 02 000 746 €	<input type="checkbox"/> 75 03 000 835 €	<input type="checkbox"/> 75 04 000 1.014 €

Frame colours			
Colour selection for size 1	Colour selection for size 2	Colour selection for size 3+4	Coated with an individual colour (on request) Please provide the requested colour here: RAL _____
			
Price	Price	Price	Price
<input type="checkbox"/> Telemagenta (Pink) (92 00 012) incl. <input type="checkbox"/> Sky blue (92 00 013) incl.	<input type="checkbox"/> Lasurit blue metallic (92 00 010) incl. <input type="checkbox"/> Traffic red (92 00 007) incl.	<input type="checkbox"/> Anthracit metallic (92 00 014) incl. <input type="checkbox"/> Pure white (92 00 100) incl.	<input type="checkbox"/> 75 00 090 104 €





Accessories					
Forearm armrests with handles adjustable in depth, height and angle, handles adjustable in depth and angle (for size 0 on request)		Forearm armrests with grip balls adjustable in depth, height and angle, handles adjustable in depth and angle (for size 0 on request)		Grip bar – pivoting, as a cross-bar between the handles (for sizes 0+4 and in combination with adjacent forearm armrests not possible)	
					
	Length	Width		Length	Width
Size 1	18 cm	6.5 cm	Size 1	18 cm	6.5 cm
Size 2	25 cm	8 cm	Size 2	25 cm	8 cm
Price / set		Price / set		Price / piece	
<input type="checkbox"/> Size 1 (75 01 001)	295 €	<input type="checkbox"/> Size 1 (75 01 002)	295 €	<input type="checkbox"/> for size 1 (75 01 003)	242 €
<input type="checkbox"/> Size 2 (75 02 001)	295 €	<input type="checkbox"/> Size 2 (75 02 002)	295 €	<input type="checkbox"/> for size 2 (75 02 003)	242 €
				<input type="checkbox"/> for size 3 (75 03 003)	242 €

Accessories			
Stops for the hand		Combined pelvic and buttock support pad for sizes 1-4 height, width and depth adjustable, PU padded	
			
		Width	
		Size 1	20 - 28 cm
		Size 2	25 - 33 cm
		Size 3	30 - 36 cm
Price / set		Price / set	
<input type="checkbox"/> 75 00 004	115 €	<input type="checkbox"/> Size 1 (75 01 005)	342 €
		<input type="checkbox"/> Size 2 (75 02 005)	342 €
		<input type="checkbox"/> Size 3 (75 03 005)	342 €
		Combined pelvic and buttock support pad for size 0 height, width and depth adjustable, PU padded	
			
		Width	
		for size 0	20 - 28 cm
Price / set		Price / set	
		<input type="checkbox"/> for size 0 (35 01 103)	342 €
		Folding seat – padded and covered (not possible for size 0)	
			
		Price / piece	
		<input type="checkbox"/> for size 1 (75 01 007)	273 €
		<input type="checkbox"/> for size 2 (75 02 007)	273 €
		<input type="checkbox"/> for size 3+4 (75 03 007)	273 €

Accessories

<p>Parking handbrake (not possible for size 0)</p>  <p>Assembly in combination with a forearm rest (not possible in combination with the grip ball)</p> 	<p>Handbrake – with extra small brake handles at reduced grip width with separate locking function</p> 	<p>Friction brake</p> 	<p>Push bar for attendant</p>  <p>new</p>
<p>Price / set</p> <p><input type="checkbox"/> for size 1 (75 01008) 210 €</p> <p><input type="checkbox"/> for size 2 (75 02008) 210 €</p> <p><input type="checkbox"/> for size 3 (75 03008) 210 €</p> <p><input type="checkbox"/> for size 4 (75 04008) 210 €</p>	<p>Price / set</p> <p><input type="checkbox"/> for size 1 (75 01015) 349 €</p> <p><input type="checkbox"/> for size 2 (75 02015) 349 €</p> <p><input type="checkbox"/> for size 3 (75 03015) 349 €</p> <p><input type="checkbox"/> for size 4 (75 04015) 349 €</p>	<p>Price / set</p> <p><input type="checkbox"/> for size 0+1 (75 00009) 68 €</p> <p><input type="checkbox"/> for size 2-4 (75 01009) 68 €</p>	<p>Price / piece</p> <p><input type="checkbox"/> for right (75 00017) 159 €</p> <p><input type="checkbox"/> for left (75 01017) 159 €</p>

Accessories

<p>Anti tip – incl. support roller (for size 0 without support roller)</p> 	<p>Deflector set (not possible for size 0)</p> 	<p>Bumper wheels – for size 0</p> 	<p>Storage basket</p> 
<p>Price / set</p> <p><input type="checkbox"/> for size 0 (35 00005) 115 €</p> <p><input type="checkbox"/> for size 1 (75 01010) 115 €</p> <p><input type="checkbox"/> for size 2-4 (75 02010) 115 €</p>	<p>Price / set</p> <p><input type="checkbox"/> 75 00012 168 €</p>	<p>Price / set</p> <p><input type="checkbox"/> 35 00010 168 €</p>	<p>Price / piece</p> <p><input type="checkbox"/> for size 0 (35 00011) 58 €</p> <p><input type="checkbox"/> for size 1-4 (75 00011) 58 €</p>



smilla.

The convenient seating aid for everyday use.

Further information can be found from page 4.



malte outdoor.

Invoice address:
Dispatch address:
 See invoice address

 Order
 Cost estimate

Customer No.: _____

Orderer: _____

Date: _____

Signature: _____

Commission:
The compact and versatile posterior-walker for outdoor use.

- Lightweight and folding aluminium frame
- Individual height and width adjustable handles
- Drum brake incl. parking handbrake
- EVA back wheels
- EVA front wheels with direction locks



HMV-No.: 10.46.02.3052

Dimensions - basic model

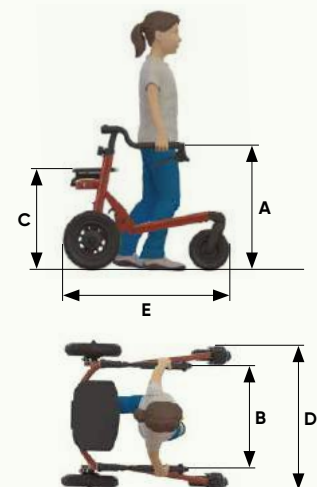
		Size 1	Size 2	Size 3
A	Handle height	34 - 58cm	51 - 75cm	68 - 94 cm
B	Handle spacing	22 - 36cm	30 - 44cm	38 - 52cm
C	Seat height	33cm	45cm	60cm
D	Total width	56cm	66cm	73cm
E	Total length	66cm	75cm	82cm
	Frame height (folded)	25cm	32cm	34cm
	Transport dimensions (LxWxH)	66x56x25cm	75x66x32cm	82x73x34cm
	Max. load	30kg	50kg	70kg
	Weight	71kg	8.3kg	9.8kg



Basic model		
malte outdoor. size 1 6" tyres (front) and 8" (rear)	malte outdoor. size 2 8" tyres (front) and 10" (rear)	malte outdoor. size 3 8" tyres (front) and 10" (rear)
Price / piece	Price / piece	Price / piece
<input type="checkbox"/> 75 01 100 861 €	<input type="checkbox"/> 75 02 100 872 €	<input type="checkbox"/> 75 03 100 961 €

Frame colours			
Colour selection for size 1	Colour selection for size 2	Colour selection for size 3	Coated with an individual colour (on request) Please provide the requested colour here: RAL _____
			
Price	Price	Price	Price
<input type="checkbox"/> Telemagenta (Pink) (92 00 012) incl. <input type="checkbox"/> Sky blue (92 00 013) incl.	<input type="checkbox"/> Lasurit blue metallic (92 00 010) incl. <input type="checkbox"/> Traffic red (92 00 007) incl.	<input type="checkbox"/> Anthracit metallic (92 00 014) incl. <input type="checkbox"/> Pure white (92 00 100) incl.	<input type="checkbox"/> 75 00 090 104 €

Accessories			
Stops for the handles	Combined pelvic and buttock support pad – height, width and depth adjustable, PU padded	Folding seat – padded and covered	Handbrake – with extra small brake handles at reduced grip width with separate locking function
			
	Width		
	Size 1 20 - 28cm		
	Size 2 25 - 33cm		
	Size 3 30 - 36cm		
Price / set	Price / set	Price / piece	Upcharge / set
<input type="checkbox"/> 75 00 004 115 €	<input type="checkbox"/> Size 1 (75 01 005) 342 € <input type="checkbox"/> Size 2 (75 02 005) 342 € <input type="checkbox"/> Size 3 (75 03 005) 342 €	<input type="checkbox"/> for size 1 (75 01 007) 273 € <input type="checkbox"/> for size 2 (75 02 007) 273 € <input type="checkbox"/> for size 3 (75 03 007) 273 €	<input type="checkbox"/> for size 1 (75 01 016) 139 € <input type="checkbox"/> for size 2 (75 02 016) 139 € <input type="checkbox"/> for size 3 (75 03 016) 139 €

Accessories				
Forearm armrests with handles adjustable in depth, height and angle, handles adjustable in depth and angle	Anti tip – incl. support roller	Backwards stop (retrofitting not possible)	Push bar for attendant 	Storage basket
				
Length				
Width				
Size 1 18cm				
Size 2 25cm				
Price / set	Price / set	Upcharge / pair	Price / piece	Price / piece
<input type="checkbox"/> Size 1 (75 01 001) 295 € <input type="checkbox"/> Size 2 (75 02 001) 295 €	<input type="checkbox"/> 75 00 010 115 €	<input type="checkbox"/> for size 1 (75 01 013) 210 € <input type="checkbox"/> for size 2+3 (75 02 013) 210 €	<input type="checkbox"/> for right (75 00 017) 159 € <input type="checkbox"/> for left (75 01 017) 159 €	<input type="checkbox"/> 75 00 011 58 €

marcy.

-
- Order**
-
-
- Cost estimate**

Customer No.: _____

Orderer: _____

Date: _____

Signature: _____

Invoice address:**Dispatch address:** See invoice address**Commission:****The anterior-walker for more independence and mobility.**

- Lightweight aluminium frame (sizes 2+3 can be folded)
- Individual height and width adjustable handles
- EVA tyres (150 mm for sizes 0+1, 200 mm for sizes 2+3)



HMV-No.: 10.46.02.3049

**Dimensions - basic model**

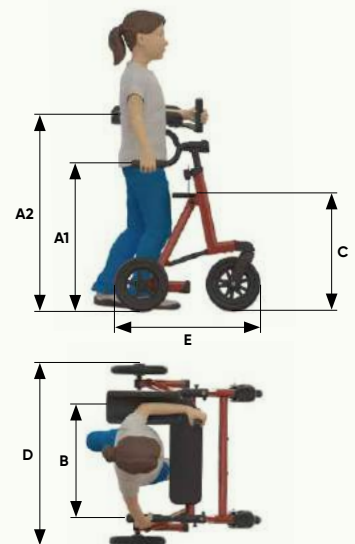
		Size 0	Size 1	Size 2	Size 3
A1	Handle height	30 - 47cm	38 - 59cm	53 - 75cm	63 - 88cm
A2	Height of forearm supports	41 - 58cm	49 - 70cm	63 - 85cm	73 - 98cm
B	Handle spacing	18 - 32cm	22 - 36cm	30 - 44cm	36 - 50cm
C	Seat height	25cm	30cm	45cm	45cm
D	Total width	44cm	48cm	62cm	71cm
E	Total length	36.5cm	42.5cm	57.5cm	61cm
E	Total length (telescopic wheelbase)	39 - 47cm	45 - 55cm	60 - 74cm	65 - 79cm
	Max. load	20kg	30kg	50kg	65kg
	Weight	4.2kg	5kg	7.4kg	9.1kg



Basic model					
marcy. size 0 - 3			marcy. size 0 - 3 (telescopic) Basic features with additional, adjustable wheelbase		
Price / piece			Price / piece		
<input type="checkbox"/> Size 0 (76 00 000)	604 €	<input type="checkbox"/> Size 0 (76 00 100)	786 €	<input type="checkbox"/> Size 1 (76 01 100)	786 €
<input type="checkbox"/> Size 1 (76 01 000)	604 €	<input type="checkbox"/> Size 2 (76 02 100)	786 €	<input type="checkbox"/> Size 3 (76 03 100)	851 €
<input type="checkbox"/> Size 2 (76 02 000)	604 €				
<input type="checkbox"/> Size 3 (76 03 000)	636 €				

Frame colours			
Colour selection for size 0+1 	Colour selection for size 2 	Colour selection for size 3 	Coated with an individual colour (on request) Please provide the requested colour here: RAL _____
Price	Price	Price	Price
<input type="checkbox"/> Telemagenta (Pink) (92 00 012) incl.	<input type="checkbox"/> Lasurit blue metallic (92 00 010) incl.	<input type="checkbox"/> Anthracit metallic (92 00 014) incl.	<input type="checkbox"/> 76 00 090 104 €
<input type="checkbox"/> Sky blue (92 00 013) incl.	<input type="checkbox"/> Traffic red (92 00 007) incl.	<input type="checkbox"/> Pure white (92 00 100) incl.	

Accessories														
Forearm armrests with handles adjustable in depth, height and angle - handles adjustable in depth and angle		Forearm armrests with grip balls adjustable in depth, height and angle - handles adjustable in depth and angle		Seat – fixed, padded and covered incl. back strap										
														
	<table border="1"> <thead> <tr> <th></th> <th>Length</th> <th>Width</th> </tr> </thead> <tbody> <tr> <td>Size 1</td> <td>18cm</td> <td>6,5cm</td> </tr> <tr> <td>Size 2</td> <td>25cm</td> <td>8cm</td> </tr> </tbody> </table>		Length	Width	Size 1	18cm	6,5cm	Size 2	25cm	8cm			Parking handbrake 	
	Length	Width												
Size 1	18cm	6,5cm												
Size 2	25cm	8cm												
	<table border="1"> <thead> <tr> <th></th> <th>Length</th> <th>Width</th> </tr> </thead> <tbody> <tr> <td>Size 1</td> <td>18cm</td> <td>6,5cm</td> </tr> <tr> <td>Size 2</td> <td>25cm</td> <td>8cm</td> </tr> </tbody> </table>		Length	Width	Size 1	18cm	6,5cm	Size 2	25cm	8cm			Assembly in combination with the forearm armrest (not possible in combination with grip balls) 	
	Length	Width												
Size 1	18cm	6,5cm												
Size 2	25cm	8cm												
Price / set		Price / set		Price / piece										
<input type="checkbox"/> Size 1 (76 01 001)	295 €	<input type="checkbox"/> Size 1 (76 01 002)	295 €	<input type="checkbox"/> for size 0 (76 00 004)	147 €									
<input type="checkbox"/> Size 2 (76 02 001)	295 €	<input type="checkbox"/> Size 2 (76 02 002)	295 €	<input type="checkbox"/> for size 1 (76 01 004)	147 €									
				<input type="checkbox"/> for size 2 (76 02 004)	147 €									
				<input type="checkbox"/> for size 3 (76 03 004)	147 €									
				<input type="checkbox"/> for size 0 (76 00 005)	210 €									
				<input type="checkbox"/> for size 1 (76 01 005)	210 €									
				<input type="checkbox"/> for size 2 (76 02 005)	210 €									
				<input type="checkbox"/> for size 3 (76 03 005)	210 €									

Accessories		
	Handbrake – with extra small brake handles at reduced grip width with separate locking function Upcharge / set <input type="checkbox"/> for size 0 (76 00 010) 349 € <input type="checkbox"/> for size 1 (76 01 010) 349 € <input type="checkbox"/> for size 2 (76 02 010) 349 € <input type="checkbox"/> for size 3 (76 03 010) 349 €	
		Friction brake Price / set <input type="checkbox"/> for size 0+1 (76 00 006) 72 € <input type="checkbox"/> for size 2+3 (76 02 006) 72 €
		
		Backwards stop Upcharge / pair <input type="checkbox"/> for size 0+1 (76 00 009) 237 € <input type="checkbox"/> for size 2+3 (76 02 009) 237 €

Accessories		
	Direction locks Price / pair <input type="checkbox"/> for size 0+1 (76 00 008) 80 € <input type="checkbox"/> for size 2+3 (76 02 008) 80 €	
		Storage basket Price / piece <input type="checkbox"/> for size 0 (76 00 007) 62 € <input type="checkbox"/> for size 1 (76 01 007) 62 € <input type="checkbox"/> for size 2+3 (76 02 007) 62 €
		
		Push bar for attendant Price / piece <input type="checkbox"/> for right (76 00 011) 159 € <input type="checkbox"/> for left (76 01 011) 159 €

dynamic pacer.

Invoice address:

- Order**
- Cost estimate**

Customer No.: _____

Orderer: _____

Date: _____

Signature: _____

Dispatch address: See invoice address

Commission:

The dynamic gait trainer.

- Modular set with various options to combine different bases and upper frames (except size 4)
- Upper frame to accommodate accessories, continuous height adjustment via gas spring support



HMV-No.: 10.46.02.3005
 (Size 0)

HMV-No.: 10.46.02.3044
 (with standard base)



HMV-No.: 10.46.02.3046
 (with utility base)



Basic model - Upper frames (sizes 1-4)

Standard upper frames		Dynamic Upper frames	
			
		Additionally, with integrated and separately adjustable vertical and horizontal dynamic for a physiological natural gait.	
Price / piece		Price / piece	
<input type="checkbox"/> Size 1 (33 01 200) (K622)	930 €	<input type="checkbox"/> Size 1 (33 01 202) (K621)	1.575 €
<input type="checkbox"/> Size 2 (33 02 200) (K632)	1.277 €	<input type="checkbox"/> Size 2 (33 02 202) (K631)	2.162 €
<input type="checkbox"/> Size 3 (33 03 200) (K642)	1.552 €	<input type="checkbox"/> Size 3 (33 03 202) (K641)	2.437 €
<input type="checkbox"/> Size 4 (33 04 200) (K652)	2.164 €	<input type="checkbox"/> Size 4 (33 04 202) (K651)	3.070 €



Basic model - Bases (sizes 1-4)

Standard base	Utility base	Treadmill/stability base
incl. four 5½" (140mm) castors with parking brake, friction brake, backwards stop and direction lock	incl. two 8" (200mm) front wheels with direction lock and two 11 ½" (290mm) rear wheels with parking brake, friction brake and backwards stop, for indoor and outdoor use (for outdoor use the function and parking handbrake must be ordered)	only for size 1 + 3, including four 5½" (140mm) castors with parking brake, friction brake, backwards stop and direction lock (only available in gray)
		
Price / piece	Price / piece	Price / piece
<input type="checkbox"/> Size 1 without odometer (33 01 204) (K624) 600 €	<input type="checkbox"/> Size 2 without odometer (33 02 206) (K636) 1.188 €	<input type="checkbox"/> standard (33 00 208) (K676) 1.508 €
<input type="checkbox"/> Size 1 with odometer (33 01 205) (K623) 837 €	<input type="checkbox"/> Size 2 with odometer (33 02 207) (K635) 1.456 €	<input type="checkbox"/> wide (33 01 208) (K678) 1.686 €
<input type="checkbox"/> Size 2 without odometer (33 02 204) (K634) 789 €	<input type="checkbox"/> Size 3 without odometer (33 03 206) (K646) 1.461 €	
<input type="checkbox"/> Size 2 with odometer (33 02 205) (K633) 1.057 €	<input type="checkbox"/> Size 3 with odometer (33 03 207) (K645) 1.729 €	
<input type="checkbox"/> Size 3 without odometer (33 03 204) (K644) 1.063 €		
<input type="checkbox"/> Size 3 with odometer (33 03 205) (K643) 1.331 €		
<input type="checkbox"/> Size 4 without odometer (33 04 204) (K654) 1.875 €		
<input type="checkbox"/> Size 4 with odometer (33 04 205) (K653) 2.102 €		

Basic model pacer mini. (size 0)

pacer mini. (size 0)	
one-piece base frame with gripping frame, 4 swivel castors with grinding brake, recoil stop, parking brake and directional fixed spring	
	
Price / piece	
<input type="checkbox"/> Size 0 without odometer (33 00 200) (K614)	1.154 €
<input type="checkbox"/> Size 0 with odometer (33 00 201) (K613)	1.413 €

Frame colours

Colour selection for size 0 (available from stock)	Colour selection for size 1 (available from stock)	Colour selection for size 2 (available from stock)	Colour selection for size 3 (available from stock)	Colour selection for size 4 (available from stock)
				
Price	Price	Price	Price	Price
<input type="checkbox"/> Lime (92 00 153) incl.	<input type="checkbox"/> Lime (92 00 153) incl. <input type="checkbox"/> White (92 00 155)	<input type="checkbox"/> Red (92 00 150) incl. <input type="checkbox"/> White (92 00 155)	<input type="checkbox"/> Blue (92 00 152) incl. <input type="checkbox"/> Anthrazit (92 00 151)	<input type="checkbox"/> Anthrazit (92 00 151) incl.

Frame colours

These frame colors are also available for all sizes with a delivery time of 6 - 8 weeks:	Price
	
<input type="checkbox"/> White (92 00 155)	incl.
<input type="checkbox"/> Anthrazit (92 00 151)	incl.
<input type="checkbox"/> Red (92 00 150)	incl.
<input type="checkbox"/> Blue (92 00 152)	incl.
<input type="checkbox"/> Lime (92 00 153)	incl.
<input type="checkbox"/> Pink (92 00 154)	incl.

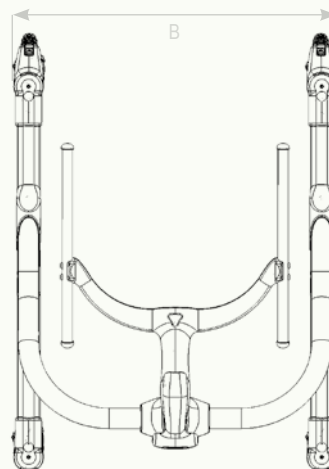
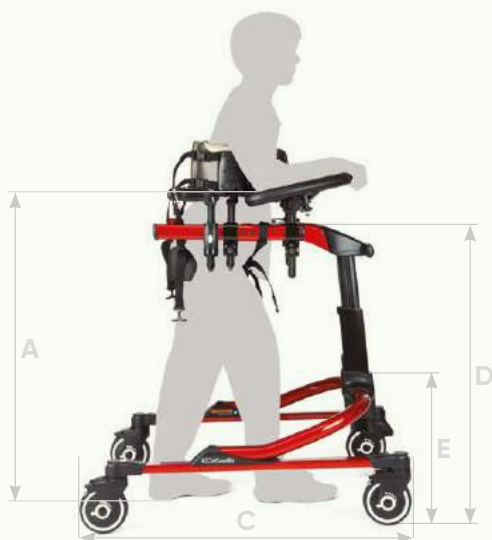
Dimensions - basic model

		Size 0	Size 1	Size 2	Size 3	Size 4	
A	Elbow height	39 – 52 cm	47 – 70 cm	61 – 89 cm	81 – 119 cm	86 – 124 cm	
B	Total width	Standard base	52 cm	58 cm	66 cm	71 cm	80 cm
		Utility base	-	-	76 cm	81 cm	-
		Narrow treadmill/stability base	-	89 cm	89 cm	89 cm	-
		Wide treadmill/stability base	-	102 cm	102 cm	102 cm	-
C	Total length	Standard base	57 cm	66 cm	76 cm	91 cm	101 cm
		Utility base	-	-	91 cm	103 cm	-
		Wide treadmill/stability base	-	104 cm	104 cm	104 cm	-
D	Frame height	Standard-/ Utility base	32 cm	41 – 53 cm	55 – 69 cm	72 – 98 cm	79 – 104 cm
		Wide treadmill/stability base	-	58 – 89 cm	60 – 93 cm	76 – 119 cm	-
E	Base height (without upper frame)	Standard-/ Utility base	-	28 cm	37 cm	41 cm	47 cm
		Wide treadmill/stability base	-	53 cm	53 cm	53 cm	-
	Weight	Standard base	4.6 kg	5.2 kg	6.8 kg	7 kg	10.2 kg
		Utility base	-	-	8.4 kg	8.7 kg	-
		Narrow treadmill/stability base	-	12.5 kg	12.5 kg	12.5 kg	-
		Wide treadmill/stability base	-	12.7 kg	12.7 kg	12.7 kg	-
		Standard upper frames	-	2.7 kg	3.4 kg	4.4 kg	4.9 kg
		Dynamischer Upper frames	-	3.4 kg	5.2 kg	6.1 kg	6.8 kg
	Dynamic upper frame movement	Vertical	-	3.5 cm	8 cm	8 cm	8 cm
		Horizontal	-	4 cm	5 cm	5 cm	5 cm
	Maximum treadmill width	Narrow treadmill/stability base	-	74 cm	74 cm	74 cm	-
		Wide treadmill/stability base	-	86 cm	86 cm	86 cm	-
	Maximum treadmill height	Wide treadmill/stability base	-	28 cm	28 cm	28 cm	-
	Max. load	23 kg	34 kg	68 kg	91 kg	113 kg	

Accessories
Multi-position saddle (MPS)

The multi-position saddle (MPS) is the ultimate positioning accessory for gait. It quickly fine tunes pelvis positioning for anterior or posterior use.

Adjustable in five directions to accommodate each client's posture, the MPS easily attaches to both the dynamic and standard upper frames.



Seat pad Dimensions	Size 1+2	Size 3
Front width (a)	7.5 cm	11.5 cm
middle width (b)	4.5 cm	6.5 cm
Rear width (c)	9 cm	13.5 cm
Length (d)	24 cm	27.5 cm

Saddle depth – adjusts to optimally position the pelvis in relation to the upper body to encourage forward motion during ambulation.

Adjustment range: 13 cm



Saddle angle – is adjustable to position the pelvis in anterior or posterior tilt for the most effective gait pattern.

Forward: 7,5° und 15°
Back: 7,5° und 15°



Saddle height – adjusts to finetune the position of the pelvis during gait.

Adjustment range: 22 cm



Hip corral – depth and height adjustments provide cushioning and support for the pelvis at the level of ASIS.

Adjustment range depth: 8 cm
Adjustment range height: 8 cm



Price / piece

<input type="checkbox"/> Size 1 for size 1	(33 01 012) (K672)	1.341 €
<input type="checkbox"/> Size 2 for size 2-4	(33 02 012) (K673)	1.388 €
<input type="checkbox"/> Size 3 for size 2-4	(33 03 012) (K674)	1.508 €

Accessories

Pelvic support – incl. bracket and a pair of handholds

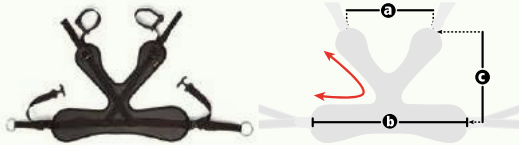

Key user dimension*	Size 0	Size 1	Size 2
a	15-20 cm	15-25 cm	20-36 cm
b	17 cm	22 cm	30 cm
c	30 cm	41 cm	51 cm

* half of thigh circumference

Hip positioner – adjustable, incl. bracket and a pair of handholds

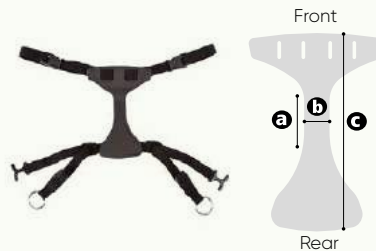

	Size 1	Size 2
Crotch length (a)	6 cm	9 cm
Width (b)	3 cm	4,5 cm
Length (c)	23 cm	28 cm

Pad – for hip positioner



	Price / Set	Price / Set	Price / piece
<input type="checkbox"/> Size 0 (33 00 015) (K556)	606 €	<input type="checkbox"/> Size 1 (33 01 003) (K513)	191 €
<input type="checkbox"/> Size 1 (33 01 015) (K557)	661 €	<input type="checkbox"/> Size 2 (33 02 003) (K533)	191 €
<input type="checkbox"/> Size 2 (33 02 015) (K558)	717 €		

Accessories
Chest prompt – incl. bracket

	Range of circumference	Height
Size 1	36 - 71cm	11cm
Size 2	56 - 102cm	17cm
Size 3	71 - 127cm	20cm
Price / piece		
<input type="checkbox"/> Size 1 (33 01 002) (K514)		705 €
<input type="checkbox"/> Size 2 (33 02 002) (K524)		762 €
<input type="checkbox"/> Size 3 (33 03 002) (K534)		762 €

Accessories
Chest unit – with back strap and holder

	Height	Range of circumference
for size 0	10cm	36 - 71cm
for size 1	10cm	36 - 71cm
for size 2	12.5cm	56 - 102cm
for size 3	15cm	71 - 127cm
Price / piece		
<input type="checkbox"/> for size 0 (33 00 020)		440 €
<input type="checkbox"/> for size 1 (33 01 020) (K629)		440 €
<input type="checkbox"/> for size 2 (33 02 020) (K639)		480 €
<input type="checkbox"/> for size 3 (33 03 020) (K649)		504 €

Handles – with bracket

	Height	Width
Size 1	12.5cm	9cm
Size 2	18cm	9cm
Price / pair		
<input type="checkbox"/> Size 1 (33 01 019) (K625)		288 €
<input type="checkbox"/> Size 2 (33 02 019) (K675)		306 €

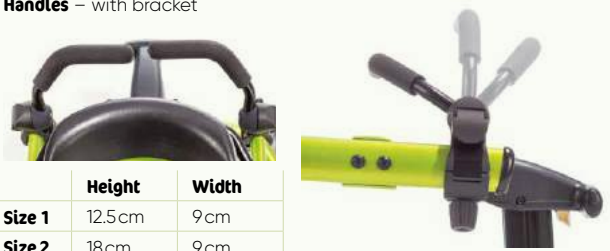
Accessories
Arm prompts – incl. handles and bracket

	Padded surface	Adjustment range (elbow to fist)
Size 1	11x18cm	20 - 32cm
Size 2	13x22cm	27 - 41cm
Price / pair		
<input type="checkbox"/> Size 1 (33 01 001) (K512)		603 €
<input type="checkbox"/> Size 2 (33 02 001) (K532)		603 €

Arm platforms – incl. bracket (recommended for sizes 2-4)

	Padded surface
without handles	34x14cm
with handles	34x14cm
Price / pair	
<input type="checkbox"/> without handles (33 00 010) (K697)	566 €
<input type="checkbox"/> with handles (33 01 010) (K696)	670 €

Accessories

	Price / pair
<input type="checkbox"/> for size 2 (33 02 011) (K687)	443 €
<input type="checkbox"/> for size 3 (33 03 011) (K688)	487 €

Functional and parking handbrake
 only for use with the utility base
 in conjunction with arm prompts





	Price / pair
<input type="checkbox"/> 33 00 008 (K579)	278 €

Grip rings – incl. bracket

Accessories

<p>Additional handholds for all sizes</p> 	<p>Therapy tray – with hollow and transparent cover</p> 	<p>Thigh prompts – incl. bracket</p> 														
	<table border="1"> <tr> <td>Inner dimensions</td> <td>22x28cm</td> </tr> <tr> <td>Max. load</td> <td>5kg</td> </tr> </table>	Inner dimensions	22x28cm	Max. load	5kg	<table border="1"> <tr> <td></td> <td>Length</td> <td>Max. leg circumference</td> </tr> <tr> <td>Size 1</td> <td>13 – 20 cm</td> <td>38 cm</td> </tr> <tr> <td>Size 2</td> <td>13 – 28 cm</td> <td>51 cm</td> </tr> </table>		Length	Max. leg circumference	Size 1	13 – 20 cm	38 cm	Size 2	13 – 28 cm	51 cm	
Inner dimensions	22x28cm															
Max. load	5kg															
	Length	Max. leg circumference														
Size 1	13 – 20 cm	38 cm														
Size 2	13 – 28 cm	51 cm														
<p>Price / pair</p>	<p>Price / piece</p>		<p>Price / pair</p>													
<p><input type="checkbox"/> 33 00 002 (K519) 170 €</p>	<p><input type="checkbox"/> for size 0 (33 00 001) (K518) 576 € <input type="checkbox"/> for size 1-4 (33 00 013) (K698) 576 €</p>		<p><input type="checkbox"/> Size 1 (33 01 005) (K515) 526 € <input type="checkbox"/> Size 2 (33 02 005) (K535) 626 €</p>													

Accessories

<p>Ankle prompts for size 0</p> 	<p>Ankle prompts for standard base</p> 	<p>Ankle prompts for utility base</p> 	<p>Ankle prompts for treadmill/stability base</p> 
<p>Price / set</p>	<p>Price / set</p>		<p>Price / set</p>
<p><input type="checkbox"/> 33 00 016 (K681) 284 €</p>	<p><input type="checkbox"/> for size 1 (33 01 016) (K682) 284 € <input type="checkbox"/> for size 2 (33 02 016) (K683) 284 € <input type="checkbox"/> for size 3+4 (33 03 016) (K684) 320 €</p>		<p><input type="checkbox"/> 33 00 018 (K664) 320 €</p>

Accessories

	<p>Attendant guide bar</p> <p>Price / piece</p> <p><input type="checkbox"/> for size 0 (33 00 009) (K589) 231 € <input type="checkbox"/> for size 1 (33 01 022) (K679) 231 € <input type="checkbox"/> for size 2-4 (33 02 022) (K689) 231 €</p>		<p>Accessories tote 35 cm x 40 cm x 23 cm</p> <p>Price / piece</p> <p><input type="checkbox"/> 33 00 014 (K522) 131 €</p>
---	---	--	---

momo tricycle.

Invoice address:
Dispatch address:
 See invoice address

 Order
 Cost estimate

Customer No.: _____

Orderer: _____

Date: _____

Signature: _____

Commission:
The tricycle as therapy aid for children, teenagers and adults.

- Aluminium frame with extra-low access point
- Rim brake with separate parking brake
- Angle adjustable handlebar stem
- Steering damper for stabilisation when moving straight on
- Drum brake in front wheel
- incl. guard plates and basket

Dimensions - basic model



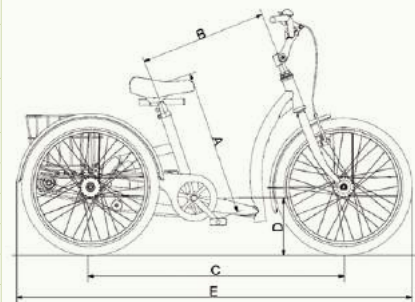



		12"	16"	20"	24"	26"	26" (XL)
A*	Pedal to upper edge of saddle	30 - 38 cm	42 - 57.5 cm	50 - 64.5 cm	56.5 - 73.5 cm	66.5 - 83 cm	74 - 90.5 cm
A**	Pedal to upper edge of saddle	33 - 41 cm	45 - 60 cm	52 - 68 cm	58 - 81.5 cm	67.5 - 91 cm	75 - 98.5 cm
B	Saddle support tube to front tube	33 cm	39 cm	45 cm	52 cm	58 cm	58 cm
C	Wheelbase	68 cm	80 cm	91 cm	104 cm	112 cm	112 cm
D	Access point height	16 cm	18 cm	20 cm	22 cm	23 cm	23 cm
E	Total length	102 cm	120 cm	140 cm	165 cm	178 cm	178 cm
	Total width	58 cm	65 cm	69 cm	75 cm	75 cm	75 cm
	Max. load	40 kg	60 kg	80 kg	100 kg	120 kg	120 kg
	Weight	12 kg	14.5 kg	17 kg	19.5 kg	21.5 kg	21.7 kg



* Dimensions with standard saddle post / ** Dimensions with T-saddle post

Basic model

momo tricycle. 12" (HMV-No.: 22.51.02.0053)	momo tricycle. 16" (HMV-No.: 22.51.02.0054)	momo tricycle. 20" (HMV-No.: 22.51.02.0055)	momo tricycle. 24" (HMV-No.: 22.51.02.0051)	momo tricycle. 26" (HMV-No.: 22.51.02.0052)	momo tricycle. 26" (XL) (HMV-No.: 22.51.02.0052)
Basic features, without drum brake and rear guard plate	Basic features	Basic features	Basic features, additional lighting system according to StVZO	Basic features, additional lighting system according to StVZO	Basic features, additional lighting system according to StVZO
Price / piece	Price / piece	Price / piece	Price / piece	Price / piece	Price / piece
<input type="checkbox"/> 37 01 000 765 €	<input type="checkbox"/> 37 02 000 1.148 €	<input type="checkbox"/> 37 03 000 1.252 €	<input type="checkbox"/> 37 04 000 1.455 €	<input type="checkbox"/> 37 05 000 1.564 €	<input type="checkbox"/> 37 06 000 1.711 €

Frame colours		
Colour selection for 12"	  	Colour selection for 16" + 20"
		  
	Price	
<input type="checkbox"/> Telemagenta (Pink) (92 00 012) <input type="checkbox"/> Sky blue (92 00 013) <input type="checkbox"/> Pure white (92 00 100)	incl.	<input type="checkbox"/> Melon yellow (92 00 006) <input type="checkbox"/> Marine blue (92 00 008) <input type="checkbox"/> Pure white (92 00 100)
		Price
		Price
		<input type="checkbox"/> Anthracit metallic (92 00 014) <input type="checkbox"/> Pure white (92 00 100)

Configuration possibilities - drive			
	Art.-No.	Drive	Upcharge / piece
	<input type="checkbox"/> 37 00 001	Rigid sprocket (Standard configuration, if nothing else stated)	incl.
	<input type="checkbox"/> 37 00 004	Freewheel brake hub (with back pedal brake)	151 €
	<input type="checkbox"/> 37 00 403	Change from rigid sprocket to neutral hub	293 €
	<input type="checkbox"/> 37 00 002	Extra light transmission (only for above drive types)	incl.
	<input type="checkbox"/> 37 00 303	Switchover from rigid sprocket, neutral hub and 3-gears-freewheel brake hub with reverse option	472 €
	<input type="checkbox"/> 37 00 005	3-gear freewheel brake hub (with back pedal brake)	199 €
	<input type="checkbox"/> 37 00 007	3-gear freewheel brake hub with reverse option	334 €
	<input type="checkbox"/> 37 00 008	7-gear freewheel brake hub (with back pedal brake)	378 €
	<input type="checkbox"/> 37 00 202	7-gear-freewheel hub with roll brake (Brake lever mounted on the handlebar, without back pedal brake)	475 €

Saddle											
Standard saddle (standard configuration, if nothing else stated)			Gel saddle				Saddle seat with leg hollows				
											
	Width	Length		Rear width	Front width	Length		Rear width	Front width	Rear length	Total length
Size 1	15cm	21cm	Size 1	19cm	4cm	24cm	Size 1	20.5cm	4cm	9.5cm	14.5cm
Size 2	15cm	24cm	Size 2	24cm	7cm	27cm	Size 2	24cm	4cm	9.5cm	14.5cm
Size 3	18cm	26cm									
	Price / piece			Upcharge / piece				Upcharge / piece			
<input type="checkbox"/> Size 1 (37 01 001)	incl.		<input type="checkbox"/> Size 1 (37 01 024)	50 €			<input type="checkbox"/> Size 1 (37 01 003)	191 €			
<input type="checkbox"/> Size 2 (37 02 001)	incl.		<input type="checkbox"/> Size 2 (37 02 024)	50 €			<input type="checkbox"/> Size 2 (37 02 003)	191 €			
<input type="checkbox"/> Size 3 (37 03 001)	incl.										

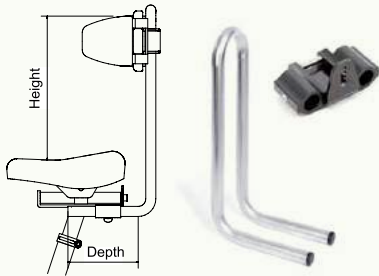

Saddle				Saddle supports											
Unicycle saddle – Banana shape (caution: min. inside leg length increases by 2 cm)				Moped saddle (caution: min. inside leg length increases by 2 cm)											
															
Rear width	Middle width	Front width	Length	Rear width	Front width	Rear length	Total length								
11cm	6cm	8cm	25cm	26cm	9.5cm	12cm	25cm								
Upcharge / piece				Upcharge / piece											
<input type="checkbox"/> 37 00 010				<input type="checkbox"/> 37 00 023											
93 €				139 €											
				Standard saddle support (standard configuration, if nothing else stated)											
															
				T-saddle support – for horizontal saddle adjustment											
															
				<table border="1" style="width: 100%; border-collapse: collapse;"> <thead> <tr> <th colspan="2" style="text-align: center;">for</th> </tr> </thead> <tbody> <tr> <td style="text-align: center;">Size 1</td> <td style="text-align: center;">12"</td> </tr> <tr> <td style="text-align: center;">Size 2</td> <td style="text-align: center;">16"</td> </tr> <tr> <td style="text-align: center;">Size 3</td> <td style="text-align: center;">20" – 26"</td> </tr> </tbody> </table>				for		Size 1	12"	Size 2	16"	Size 3	20" – 26"
for															
Size 1	12"														
Size 2	16"														
Size 3	20" – 26"														
				Price / piece											
				Upcharge / piece											
				<input type="checkbox"/> Size 1 (37 01 004) incl. <input type="checkbox"/> Size 2 (37 02 004) incl. <input type="checkbox"/> Size 3 (37 03 004) incl.											
				<input type="checkbox"/> Size 1 (37 01 005) 73 € <input type="checkbox"/> Size 2 (37 02 005) 73 € <input type="checkbox"/> Size 3 (37 03 005) 73 €											

Holding brackets			Headrest			
Holding brackets incl. holder – only for use together with the T-saddle support			Headrest – only for use together with a holding bracket			
	Max. height*	Depth				
Size 1	20 cm	12 cm				
Size 2	30 cm	12 cm				
Size 3	37 cm	12 cm				
Size 4	53 cm	12 cm				
Tailored	___ cm (max. 85 cm)	___ cm (max. 30 cm)				
			Width	Height		
			Size 1	20 cm	15 cm	
			Size 2	23 cm	18 cm	
* Max. height: measured from the standard saddle to the top edge of the respective support pad						
			Price / set		Price / piece	
<input type="checkbox"/> Size 1	(37 01007)		114 €		<input type="checkbox"/> Size 1 (37 01 029)	303 €
<input type="checkbox"/> Size 2	(37 02007)		114 €		<input type="checkbox"/> Size 2 (37 02 029)	303 €
<input type="checkbox"/> Size 3	(37 03007)		114 €			
<input type="checkbox"/> Size 4	(37 04007)		114 €			
<input type="checkbox"/> Tailored	(37 09007)		240 €			

Torso supports		Pelvic supports	
Dynamic back support pad padded with strap and bracket (only for use together with a holding bracket)		Width adjustable back support pad padded, incl. bracket (only for use together with a holding bracket)	
			
Width		Width	
Size 1	20 - 30 cm	Size 1	20 - 28 cm
Size 2	25 - 35 cm	Size 2	25 - 33 cm
Size 3	30 - 40 cm	Size 3	30 - 36 cm
Price / piece		Price / piece	
<input type="checkbox"/> Size 1 (37 01008)	213 €	<input type="checkbox"/> Size 1 (37 01025)	286 €
<input type="checkbox"/> Size 2 (37 02008)	213 €	<input type="checkbox"/> Size 2 (37 02025)	286 €
<input type="checkbox"/> Size 3 (37 03008)	213 €	<input type="checkbox"/> Size 3 (37 03025)	286 €
		Dynamic pelvic guide support pad padded with strap and bracket (only for use together with a holding bracket)	
			
		Width	
Size 1	20 - 30 cm	Size 1	20 - 28 cm
Size 2	25 - 35 cm	Size 2	25 - 33 cm
Size 3	30 - 40 cm	Size 3	30 - 36 cm
Price / piece		Price / piece	
<input type="checkbox"/> Size 1 (37 01009)	213 €	<input type="checkbox"/> Size 1 (37 01026)	286 €
<input type="checkbox"/> Size 2 (37 02009)	213 €	<input type="checkbox"/> Size 2 (37 02026)	286 €
<input type="checkbox"/> Size 3 (37 03009)	213 €	<input type="checkbox"/> Size 3 (37 03026)	286 €
		Width adjustable pelvic guide support pad – padded, incl. bracket (only for use together with a holding bracket)	
			
		Width	
Size 1	20 - 30 cm	Size 1	20 - 28 cm
Size 2	25 - 35 cm	Size 2	25 - 33 cm
Size 3	30 - 40 cm	Size 3	30 - 36 cm
Price / piece		Price / piece	
<input type="checkbox"/> Size 1 (37 01029)	303 €	<input type="checkbox"/> Size 1 (37 01026)	286 €
<input type="checkbox"/> Size 2 (37 02029)	303 €	<input type="checkbox"/> Size 2 (37 02026)	286 €
<input type="checkbox"/> Size 3 (37 03029)	240 €	<input type="checkbox"/> Size 3 (37 03026)	286 €

Harness system			
Chest strap – for width adjustable back support pad		Positioning jacket – for width adjustable back support pad	
			
	Width	Length	
Size 1	5 cm	18.5 cm	
Size 2	6.5 cm	25.5 cm	
Size 3	7 cm	30.5 cm	
Price / piece		Price / piece	
<input type="checkbox"/> Size 1 (37 01050)	86 €	<input type="checkbox"/> Size 1 (37 01051)	213 €
<input type="checkbox"/> Size 2 (37 02050)	86 €	<input type="checkbox"/> Size 2 (37 02051)	213 €
<input type="checkbox"/> Size 3 (37 03050)	86 €	<input type="checkbox"/> Size 3 (37 03051)	213 €
		Inside width	Total width
		Side height	Total height
Size 1		8 cm	25 cm
Size 2		9 cm	30 cm
Size 3		12 cm	34 cm
Size 1		10 cm	28 cm
Size 2		12 cm	30 cm
Size 3		16 cm	35 cm
Price / piece		Price / piece	
<input type="checkbox"/> Size 1 (37 01051)	213 €	<input type="checkbox"/> Size 1 (37 01051)	213 €
<input type="checkbox"/> Size 2 (37 02051)	213 €	<input type="checkbox"/> Size 2 (37 02051)	213 €
<input type="checkbox"/> Size 3 (37 03051)	213 €	<input type="checkbox"/> Size 3 (37 03051)	213 €

Lenkung

Push bar height adjustable and removable with integrated twist lock 	Parking brake for attendant (can only be used in connection with a push bar) 	Steering for attendant – via deflection bar, incl. steering stop, in this case the steering damper is omitted, (can only be used in connection with a push bar) 	<table border="1"> <tr> <td colspan="2">Price / piece</td> </tr> <tr> <td><input type="checkbox"/> for 12" (3701010)</td> <td>400 €</td> </tr> <tr> <td><input type="checkbox"/> for 16" (3702010)</td> <td>400 €</td> </tr> <tr> <td><input type="checkbox"/> for 20" (3703010)</td> <td>400 €</td> </tr> <tr> <td><input type="checkbox"/> for 24" (3704010)</td> <td>400 €</td> </tr> <tr> <td><input type="checkbox"/> for 26" (3705010)</td> <td>400 €</td> </tr> </table>	Price / piece		<input type="checkbox"/> for 12" (3701010)	400 €	<input type="checkbox"/> for 16" (3702010)	400 €	<input type="checkbox"/> for 20" (3703010)	400 €	<input type="checkbox"/> for 24" (3704010)	400 €	<input type="checkbox"/> for 26" (3705010)	400 €
Price / piece															
<input type="checkbox"/> for 12" (3701010)	400 €														
<input type="checkbox"/> for 16" (3702010)	400 €														
<input type="checkbox"/> for 20" (3703010)	400 €														
<input type="checkbox"/> for 24" (3704010)	400 €														
<input type="checkbox"/> for 26" (3705010)	400 €														
<table border="1"> <tr> <td>Price / piece</td> <td></td> </tr> <tr> <td><input type="checkbox"/> 3700011</td> <td>158 €</td> </tr> </table>	Price / piece		<input type="checkbox"/> 3700011	158 €	<table border="1"> <tr> <td>Price / piece</td> <td></td> </tr> <tr> <td><input type="checkbox"/> 3700012</td> <td>105 €</td> </tr> </table>	Price / piece		<input type="checkbox"/> 3700012	105 €						
Price / piece															
<input type="checkbox"/> 3700011	158 €														
Price / piece															
<input type="checkbox"/> 3700012	105 €														

Crank

Progressively adjustable crank reducer without widening the pedal distance 	Crank reducer – minimal pedal distance widening – reduction in size by 2.5 or 5 cm respectively 	Special crank for knee contracture for 20" – 26" 																		
<table border="1"> <tr> <td>Price / pair</td> <td></td> </tr> <tr> <td><input type="checkbox"/> for 12"-20" (3700016)</td> <td>156 €</td> </tr> <tr> <td><input type="checkbox"/> for 24"+26" (3704016)</td> <td>156 €</td> </tr> </table>	Price / pair		<input type="checkbox"/> for 12"-20" (3700016)	156 €	<input type="checkbox"/> for 24"+26" (3704016)	156 €	<table border="1"> <tr> <td>Price / pair</td> <td></td> </tr> <tr> <td><input type="checkbox"/> for 16"+20" (3702015)</td> <td>80 €</td> </tr> <tr> <td><input type="checkbox"/> for 24"+26" (3705015)</td> <td>80 €</td> </tr> </table>	Price / pair		<input type="checkbox"/> for 16"+20" (3702015)	80 €	<input type="checkbox"/> for 24"+26" (3705015)	80 €	<table border="1"> <tr> <td>Price / piece</td> <td></td> </tr> <tr> <td><input type="checkbox"/> mounted on right (3703015)</td> <td>332 €</td> </tr> <tr> <td><input type="checkbox"/> mounted on left (3704015)</td> <td>332 €</td> </tr> </table>	Price / piece		<input type="checkbox"/> mounted on right (3703015)	332 €	<input type="checkbox"/> mounted on left (3704015)	332 €
Price / pair																				
<input type="checkbox"/> for 12"-20" (3700016)	156 €																			
<input type="checkbox"/> for 24"+26" (3704016)	156 €																			
Price / pair																				
<input type="checkbox"/> for 16"+20" (3702015)	80 €																			
<input type="checkbox"/> for 24"+26" (3705015)	80 €																			
Price / piece																				
<input type="checkbox"/> mounted on right (3703015)	332 €																			
<input type="checkbox"/> mounted on left (3704015)	332 €																			

Pedals

Foot fixing pedals – with racing hooks and compensation weights 	Home exerciser pedals 	Foot cups – width adjustable, with fixing straps  <table border="1"> <tr> <td></td> <td>Min. front width</td> <td>Max. front width</td> <td>Min. rear width</td> <td>Max. rear width</td> <td>Length</td> </tr> <tr> <td>Size 1</td> <td>8.7 cm</td> <td>10.4 cm</td> <td>5.7 cm</td> <td>7.4 cm</td> <td>17.4 cm</td> </tr> <tr> <td>Size 2</td> <td>9.5 cm</td> <td>12 cm</td> <td>6.7 cm</td> <td>9.2 cm</td> <td>20.1 cm</td> </tr> <tr> <td>Size 3</td> <td>11.5 cm</td> <td>14 cm</td> <td>8.1 cm</td> <td>10.6 cm</td> <td>23.8 cm</td> </tr> </table>		Min. front width	Max. front width	Min. rear width	Max. rear width	Length	Size 1	8.7 cm	10.4 cm	5.7 cm	7.4 cm	17.4 cm	Size 2	9.5 cm	12 cm	6.7 cm	9.2 cm	20.1 cm	Size 3	11.5 cm	14 cm	8.1 cm	10.6 cm	23.8 cm
	Min. front width	Max. front width	Min. rear width	Max. rear width	Length																					
Size 1	8.7 cm	10.4 cm	5.7 cm	7.4 cm	17.4 cm																					
Size 2	9.5 cm	12 cm	6.7 cm	9.2 cm	20.1 cm																					
Size 3	11.5 cm	14 cm	8.1 cm	10.6 cm	23.8 cm																					
<table border="1"> <tr> <td>Upcharge / pair</td> <td></td> </tr> <tr> <td><input type="checkbox"/> 3700013</td> <td>84 €</td> </tr> </table>	Upcharge / pair		<input type="checkbox"/> 3700013	84 €	<table border="1"> <tr> <td>Upcharge / pair</td> <td></td> </tr> <tr> <td><input type="checkbox"/> 3700014</td> <td>58 €</td> </tr> </table>	Upcharge / pair		<input type="checkbox"/> 3700014	58 €	<table border="1"> <tr> <td>Price / pair</td> <td></td> </tr> <tr> <td><input type="checkbox"/> Size 1 (3701017)</td> <td>197 €</td> </tr> <tr> <td><input type="checkbox"/> Size 2 (3702017)</td> <td>197 €</td> </tr> <tr> <td><input type="checkbox"/> Size 3 (3704017)</td> <td>197 €</td> </tr> </table>	Price / pair		<input type="checkbox"/> Size 1 (3701017)	197 €	<input type="checkbox"/> Size 2 (3702017)	197 €	<input type="checkbox"/> Size 3 (3704017)	197 €								
Upcharge / pair																										
<input type="checkbox"/> 3700013	84 €																									
Upcharge / pair																										
<input type="checkbox"/> 3700014	58 €																									
Price / pair																										
<input type="checkbox"/> Size 1 (3701017)	197 €																									
<input type="checkbox"/> Size 2 (3702017)	197 €																									
<input type="checkbox"/> Size 3 (3704017)	197 €																									

Foot cups with leg guidance

Foot cups with leg guidance – width adjustable and with fixing straps								
	Min. front width	Max. front width	Min. rear width	Max. rear width	Length	Min. leg guide height	Max. leg guide height	
Size 1	8.7 cm	10.4 cm	5.7 cm	7.4 cm	17.4 cm	15 cm	18.5 cm	
Size 2	9.5 cm	12 cm	6.7 cm	9.2 cm	20.1 cm	18 cm	22 cm	
Size 3	11.5 cm	14 cm	8.1 cm	10.6 cm	23.8 cm	21 cm	26 cm	
Size 4	11.5 cm	14 cm	8.1 cm	10.6 cm	23.8 cm	28 cm	36 cm	
	Price / pair							
<input type="checkbox"/> Size 1 (3701018)								334 €
<input type="checkbox"/> Size 2 (3702018)								334 €
<input type="checkbox"/> Size 3 (3703018)								334 €
<input type="checkbox"/> Size 4 (3704018)								334 €

Foot cups with dynamic leg guidance
Foot cups with dynamic leg guidance

width adjustable and with fixing straps

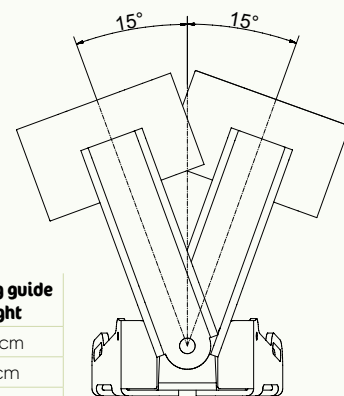



	Min. front width	Max. front width	Min. rear width	Max. rear width	Length	Min. leg guide Height	Max. leg guide Height
Size 1	8.7 cm	10.4 cm	5.7 cm	7.4 cm	17.4 cm	15 cm	18.5 cm
Size 2	9.5 cm	12 cm	6.7 cm	9.2 cm	20.1 cm	18 cm	22 cm
Size 3	12 cm	15 cm	8.8 cm	11.8 cm	24 cm	20.5 cm	25.5 cm

Price / pair

<input type="checkbox"/> Size 1 (37 01 035)	437 €
<input type="checkbox"/> Size 2 (37 02 035)	437 €
<input type="checkbox"/> Size 3 (37 03 035)	437 €

Configuration possibilities - lighting system

 	Art.-No.	Lighting system	for	Upcharge / set
	<input type="checkbox"/> 37 03 021		Upgrade with a lighting system with side runners and reflectors according to StVZO (mounted on the rear wheel)	12"
<input type="checkbox"/> 37 02 021		Upgrade with a lighting system with side runners and reflectors according to StVZO	16"+20"	171 €
<input type="checkbox"/> 37 01 021		Upgrade with a lighting system with hub dynamo and reflectors according to StVZO	16"+20"	288 €
<input type="checkbox"/> 37 04 021		Lighting system with hub dynamo	24"+26"	122 €

Axle arm
Removable axle arm – not possible for switchover drives

	Price / set
<input type="checkbox"/> for 20" (37 03 023)	478 €
<input type="checkbox"/> for 24" (37 04 023)	478 €
<input type="checkbox"/> for 26" (37 05 023)	478 €

momo motion. - The tricycle with E-drive

A motor support when using a tricycle is useful for many users and necessary due to the indication. Thus, for some users, the starting situation is often the only obstacle to independent use of the bike. With clinical pictures such as dystrophies, permanent support is required to compensate the relative loss of muscle strength.

In order to make the medical benefits of riding a tricycle accessible to these people, we have developed our **momo motion.**

The corresponding order form for our **momo motion.** as well as further information on the possibilities of motor support can be found on page 100 or on our homepage at www.schuchmann.de/en/momo-motion.



Invoice address:

Order

Cost estimate

Customer No.: _____

Orderer: _____

Date: _____

Signature: _____

Dispatch address: See invoice address

Commission:





The clever parent-child tandem coupling for momo tricycles.

- To suit all **Schuchmann tricycles** with free wheeling and / or switchover to free wheeling
- For all 26" and 28" adult's bicycles with and without rear suspension with quick release wheel fixation
- Wheels with full axle or wheel hub gears can be prepared using optionally available adaptors
- The child's seat, luggage carrier and bags can still be fully used on the leading bicycle
- It is possible to attach and remove the tricycle within seconds
- Incl. special axle nuts



Dimensions - basic model			
	Size 1	Size 2	Size 3
Required size of the leading bicycle	26"-28"	26"-28"	26"-28"
Max. tricycle size	12" (to be used also for 16" + 20")	16"+20"	24"+26"
Max. traction weight	40 kg	60 kg	80 kg
Weight	5.1kg	5.1kg	8.7 kg

Basic model					
follow-me momo. size 1 for 12"		follow-me momo. size 2 for 16"+20"		follow-me momo. size 3 for 24"+26"	
Price / piece		Price / piece		Price / piece	
<input type="checkbox"/> 39 00 100	439 €	<input type="checkbox"/> 39 01 100	439 €	<input type="checkbox"/> 39 02 100	648 €

Adapter for rear axle of the leading bicycle					
Hub or chain gears and quick release with a max. frame width of 150 mm	Hub or chain gears and quick release with a max. frame width of 150 mm bis 175 mm	Hub or chain gears with full axle and nuts	Hub gears and Clickbox	Hub or chain gears and thru axle	
					
One of these four adapters is included. Each additional adapter will be charged at 79 € / set.					
Price / set		Price / set		Price / set	
<input type="checkbox"/> 39 01 101	incl.	<input type="checkbox"/> 39 02 101	incl.	<input type="checkbox"/> 39 01 102	incl.
				<input type="checkbox"/> 39 01 103	incl.
				<input type="checkbox"/> 39 01 104	on request

Accessories	
<p>Suspension bracket – for luggage carrier with „Top-Light“, incl. carabiner hooks and assembly instructions (incl. for size 3)</p> 	<p>Preparation of the follow-me momo. – adjustment of the follow-me momo. to wheel size of the tricycle (at Schuchmann)</p>
Price / piece	Net price (not discountable)
<input type="checkbox"/> 39 01 109	23 €
<input type="checkbox"/> 39 01 110	34 €

Note	
<p>Adult bike with rear engine – if the adult bike on which the follow-me momo. is to be mounted is equipped with a rear engine, then an adapter other than described above is needed. Please contact us in such case and we will work with you to develop an adapter solution.</p>	<p>momo motion. or momo tricycle. with electric drive in combination with the follow-me momo. Generally we do not recommend to pair a momo motion. or momo tricycle. which is equipped with an electric drive, via follow-me momo. with an adult bike. This can lead to dangerous situations due to the support that comes from the electric drive. Please contact us if you still require this combination. We will gladly try to find a solution together with you.</p>

momo motion.

Invoice address:

Dispatch address: See invoice address

Order

Cost estimate

Customer No.: _____

Orderer: _____

Date: _____

Signature: _____

Commission:

The tried-and-tested tricycle with E-drive.

- With Heinzmann Direct Power Motor (36 V, 250 W, impulse torque 60 Nm)
- Aluminium frame with extra-low access point
- Rim brake with separate parking brake
- Angle adjustable handlebar stem
- Handlebar damper for stabilisation when moving straight on
- Lighting system according to StVZO, which is powered by the Li-ion high-power battery (14.25 Ah)
- Incl. mudguards and basket

HMV-No.: 22.51.04.0005



Dimensions - basic model						
		16"	20"	24"	26"	26" (XL)
A*	Pedal to upper edge of saddle	42 - 57.5 cm	50 - 64.5 cm	56.5 - 73.5 cm	66.5 - 83 cm	74 - 90.5 cm
A**	Pedal to upper edge of saddle	45 - 60 cm	52 - 68 cm	58 - 81.5 cm	67.5 - 91 cm	75 - 98.5 cm
B	Saddle support tube to front tube	39 cm	45 cm	52 cm	58 cm	58 cm
C	Wheelbase	80 cm	91 cm	104 cm	112 cm	112 cm
D	Access point height	18 cm	20 cm	22 cm	23 cm	23 cm
E	Total length	120 cm	140 cm	165 cm	178 cm	178 cm
	Total width	65 cm	69 cm	75 cm	75 cm	75 cm
	Max. load	60 kg	80 kg	100 kg	120 kg	120 kg
	Weight	24.5 kg	27 kg	29.5 kg	31.5 kg	31.7 kg

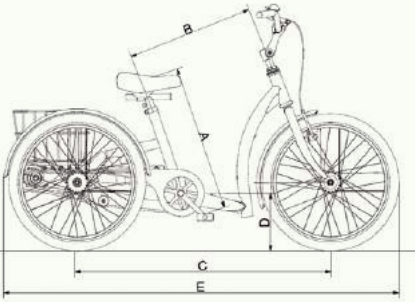

* Dimensions with standard saddle post / ** Dimensions with T-saddle post

Basic model				
momo motion. 16"	momo motion. 20"	momo motion. 24"	momo motion. 26"	momo motion. 26" (XL)
Price / piece	Price / piece	Price / piece	Price / piece	Price / piece
<input type="checkbox"/> 36 02 000 3.833 €	<input type="checkbox"/> 36 03 000 3.938 €	<input type="checkbox"/> 36 04 000 4.022 €	<input type="checkbox"/> 36 05 000 4.138 €	<input type="checkbox"/> 36 06 000 4.285 €

Frame colours			
Colour selection for 16" + 20"		Colour selection for 24" + 26" + 26" XL	
<input type="checkbox"/> Melon yellow (92 00 006)	<input type="checkbox"/> Marine blue (92 00 008)	<input type="checkbox"/> Anthracit metallic (92 00 014)	<input type="checkbox"/> Pure white (92 00 100)
	Price		Price
<input type="checkbox"/> Pure white (92 00 100)	incl.	<input type="checkbox"/> Anthracit metallic (92 00 014)	incl.
	incl.	<input type="checkbox"/> Pure white (92 00 100)	incl.
	incl.		

E - drive
DirectPower E-drive from Heinzmann

The new **momo motion** is equipped with the DirectPower E-drive from Heinzmann. This allows us to offer you a wear-free and silent direct drive. The motor is designed to be brushless and without gears. This minimises maintenance and wear and eliminates motor noise. The recuperative system automatically recharges when driving downhill or braking. This means that the range can be increased by up to 15 %. The existing force of the user is measured by a force sensor integrated in the bottom bracket, and the assistance from the electric drive is adjusted.

Choose the suitable E-drive for the **momo motion**, from the following configurations. You can choose whether the drive should be equipped **with or without start-up assistance**. In addition, you can choose between a **beginner version** and an **advanced version**. The difference here is the **start-up** and the **top speed** of the various modes **Eco**, **Standard** and **Power**, which can be selected via the display. An analysis cable can be used to change the selected version at a later date.

E - drive configuration
DirectPower E-drive from Heinzmann – without start-up assistance

for size	Version	Start-up handling / top speed			Price / piece
		Eco	Standard	Power	
16"	<input type="checkbox"/> Beginner (3602 070)	gentle / 4 km/h	medium / 4 km/h	strong / 6 km/h	incl.
	<input type="checkbox"/> Advanced (3602 071)	medium / 6 km/h	strong / 8 km/h	strong / 10 km/h	incl.
20"	<input type="checkbox"/> Beginner (3603 070)	gentle / 4 km/h	medium / 4 km/h	strong / 6 km/h	incl.
	<input type="checkbox"/> Advanced (3603 071)	medium / 6 km/h	strong / 8 km/h	strong / 12 km/h	incl.
24"	<input type="checkbox"/> Beginner (3604 070)	gentle / 6 km/h	medium / 8 km/h	strong / 12 km/h	incl.
	<input type="checkbox"/> Advanced (3604 071)	gentle / 10 km/h	medium / 15 km/h	strong / 20 km/h	incl.
26"	<input type="checkbox"/> Beginner (3605 070)	gentle / 6 km/h	medium / 8 km/h	strong / 12 km/h	incl.
	<input type="checkbox"/> Advanced (3605 071)	gentle / 10 km/h	medium / 15 km/h	strong / 20 km/h	incl.

E - drive configuration
DirectPower E-drive from Heinzmann – with start-up assistance

Select whether the start-up assistance should be activated by pressing the button **(Fig. 1)** or by twist handle **(Fig. 2)**



for size	Version	Start-up assistance	Start-up handling / top speed			Upcharge / piece
			Eco	Standard	Power	
16"	<input type="checkbox"/> Beginner with twist handle (3602 072)	4 km/h	gentle / 4 km/h	medium / 4 km/h	strong / 6 km/h	103 €
	<input type="checkbox"/> Beginner with button (3602 073)					103 €
	<input type="checkbox"/> Advanced with twist handle (3602 074)	6 km/h	medium / 6 km/h	strong / 8 km/h	strong / 10 km/h	103 €
	<input type="checkbox"/> Advanced with button (3602 075)					103 €
20"	<input type="checkbox"/> Beginner with twist handle (3603 072)	4 km/h	gentle / 4 km/h	medium / 4 km/h	strong / 6 km/h	103 €
	<input type="checkbox"/> Beginner with button (3603 073)					103 €
	<input type="checkbox"/> Advanced with twist handle (3603 074)	6 km/h	medium / 6 km/h	strong / 8 km/h	strong / 12 km/h	103 €
	<input type="checkbox"/> Advanced with button (3603 075)					103 €
24"	<input type="checkbox"/> Beginner with twist handle (3604 072)	6 km/h	gentle / 6 km/h	medium / 8 km/h	strong / 12 km/h	103 €
	<input type="checkbox"/> Beginner with button (3604 073)					103 €
	<input type="checkbox"/> Advanced with twist handle (3604 074)	6 km/h	gentle / 10 km/h	medium / 15 km/h	strong / 20 km/h	103 €
	<input type="checkbox"/> Advanced with button (3604 075)					103 €
26"	<input type="checkbox"/> Beginner with twist handle (3605 072)	6 km/h	gentle / 6 km/h	medium / 8 km/h	strong / 12 km/h	103 €
	<input type="checkbox"/> Beginner with button (3605 073)					103 €
	<input type="checkbox"/> Advanced with twist handle (3605 074)	6 km/h	gentle / 10 km/h	medium / 15 km/h	strong / 20 km/h	103 €
	<input type="checkbox"/> Advanced with button (3605 075)					103 €

Software

Subsequent conversion/adjustment of the software on the delivered product by our sales force



Net price (not discountable) / piece

36 00 090 134 €

Configuration possibilities - drive			
	Art.-No.	Drive	Upcharge / piece
	<input type="checkbox"/> 3600001	Freewheel brake hub (with back pedal brake)	incl.
	<input type="checkbox"/> 3601001	3-gear freewheel brake hub (with back pedal brake)	199 €
	<input type="checkbox"/> 3602001	3-gear freewheel brake hub with reverse option	334 €
	<input type="checkbox"/> 3603001	7-gear freewheel brake hub (with back pedal brake)	378 €
<input type="checkbox"/> 3604001	7-gear-freewheel hub with roll brake (Brake lever mounted on the handlebar, without back pedal brake)	475 €	

Saddle											
Standard saddle (standard configuration, if nothing else stated)			Gel saddle				Saddle seat with leg hollows				
											
	Width	Length		Rear width	Front width	Length		Rear width	Front width	Rear length	Total length
Size 1	15 cm	21 cm									
Size 2	15 cm	24 cm	Size 1	19 cm	4 cm	24 cm	Size 1	20.5 cm	4 cm	9.5 cm	14.5 cm
Size 3	18 cm	26 cm	Size 2	24 cm	7 cm	27 cm	Size 2	24 cm	4 cm	9.5 cm	14.5 cm
Price / piece			Upcharge / piece				Upcharge / piece				
<input type="checkbox"/> Size 1 (3701001) <input type="checkbox"/> Size 2 (3702001) <input type="checkbox"/> Size 3 (3703001)			<input type="checkbox"/> Size 1 (3701024) 50 € <input type="checkbox"/> Size 2 (3702024) 50 €				<input type="checkbox"/> Size 1 (3701003) 191 € <input type="checkbox"/> Size 2 (3702003) 191 €				

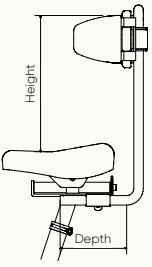
Saddle								Saddle supports			
Unicycle saddle – Banana shape (caution: min. inside leg length increases by 2 cm)				Moped saddle (caution: min. inside leg length increases by 2 cm)				Standard saddle support (standard configuration, if nothing else stated)		T-saddle support – for horizontal saddle adjustment	
											
Rear width	Middle width	Front width	Length	Rear width	Front width	Rear length	Total length		for		for
11 cm	6 cm	8 cm	25 cm	26 cm	9.5 cm	12 cm	25 cm		Size 2 16"		Size 2 16"+20"
									Size 3 20"-26"		Size 3 24"+26"
Upcharge / piece				Upcharge / piece				Price / piece		Upcharge / piece	
<input type="checkbox"/> 3700010 93 €				<input type="checkbox"/> 3700023 139 €				<input type="checkbox"/> Size 2 (3702004) incl. <input type="checkbox"/> Size 3 (3703004) incl.		<input type="checkbox"/> Size 2 (3702005) 73 € <input type="checkbox"/> Size 3 (3703005) 73 €	

Holding brackets			Headrest		
Holding brackets incl. holder – only for use together with the T-saddle support			Headrest – only for use together with a holding bracket		
	Max. height*	Depth	 		
Size 1	20 cm	12 cm			
Size 2	30 cm	12 cm			
Size 3	37 cm	12 cm			
Size 4	53 cm	12 cm			
Tailored	___ cm (Max. 85 cm)	___ cm (Max. 30 cm)			
* Max. height: measured from the standard saddle to the top edge of the respective support pad			Width	Height	
			Size 1	20 cm	15 cm
			Size 2	23 cm	18 cm
			Price / set		
<input type="checkbox"/> Size 1	(37 01 007)		114 €		
<input type="checkbox"/> Size 2	(37 02 007)		114 €		
<input type="checkbox"/> Size 3	(37 03 007)		114 €		
<input type="checkbox"/> Size 4	(37 04 007)		114 €		
<input type="checkbox"/> Tailored	(37 09 007)		240 €		
			Price / piece		
			<input type="checkbox"/> Size 1	(37 01 029)	303 €
			<input type="checkbox"/> Size 2	(37 02 029)	303 €

Torso supports		Pelvic supports			
Dynamic back support pad padded with strap and bracket (only for use together with a holding bracket)	Width adjustable back support pad padded, incl. bracket (only for use together with a holding bracket)	Dynamic pelvic guide support pad padded with strap and bracket (only for use together with a holding bracket)	Width adjustable pelvic guide support pad – padded, incl. bracket (only for use together with a holding bracket)		
					
Width	Width	Width	Width		
Size 1	20 – 30 cm	Size 1	20 – 28 cm		
Size 2	25 – 35 cm	Size 2	25 – 33 cm		
Size 3	30 – 40 cm	Size 3	30 – 36 cm		
Price / piece		Price / piece			
<input type="checkbox"/> Size 1	(37 01 008)	213 €	<input type="checkbox"/> Size 1	(37 01 025)	286 €
<input type="checkbox"/> Size 2	(37 02 008)	213 €	<input type="checkbox"/> Size 2	(37 02 025)	286 €
<input type="checkbox"/> Size 3	(37 03 008)	213 €	<input type="checkbox"/> Size 3	(37 03 025)	286 €
<input type="checkbox"/> Size 1	(37 01 009)	213 €	<input type="checkbox"/> Size 1	(37 01 026)	286 €
<input type="checkbox"/> Size 2	(37 02 009)	213 €	<input type="checkbox"/> Size 2	(37 02 026)	286 €
<input type="checkbox"/> Size 3	(37 03 009)	213 €	<input type="checkbox"/> Size 3	(37 03 026)	286 €

Harness system					
Chest strap – for width adjustable back support pad			Positioning jacket – for width adjustable back support pad, incl. universal bracket		
	Width	Length			
Size 1	5 cm	18.5 cm			
Size 2	6.5 cm	25.5 cm			
Size 3	7 cm	30.5 cm			
Price / piece			Price / piece		
<input type="checkbox"/> Size 1	(37 01 050)	86 €	<input type="checkbox"/> Size 1	(37 01 051)	213 €
<input type="checkbox"/> Size 2	(37 02 050)	86 €	<input type="checkbox"/> Size 2	(37 02 051)	213 €
<input type="checkbox"/> Size 3	(37 03 050)	86 €	<input type="checkbox"/> Size 3	(37 03 051)	213 €

Harness system

T-shape groin harness – for width adjustable pelvic support pad					4-point pelvic harness – for width adjustable pelvic support pad						
	Width of seat	Front width	Length of seat	Total length		Width of outer parts	Width of centre section	Outer part length	Centre section length		
Size 1	24 cm	23 cm	15 cm	32 cm		Size 1	7 cm	7 cm	12 cm	12 cm	
Size 2	26 cm	26 cm	17 cm	34 cm		Size 2	9 cm	8.5 cm	13 cm	14 cm	
Size 3	28 cm	28 cm	19 cm	38 cm		Size 3	11.5 cm	11 cm	15 cm	16 cm	
Price / piece					Price / piece						
<input type="checkbox"/> Size 1 (37 01 052) 146 € <input type="checkbox"/> Size 2 (37 02 052) 146 € <input type="checkbox"/> Size 3 (37 03 052) 146 €					<input type="checkbox"/> Size 1 (37 01 053) 150 € <input type="checkbox"/> Size 2 (37 02 053) 150 € <input type="checkbox"/> Size 3 (37 03 053) 150 €						

Accessories

Universal bracket for harness used without support pads (width = 275 cm)		Steering stop – adjustable up to direction lock (incl. for steering for attendant)		Handlebar extension	
	for		for		Length
	16"-26"		16"-26"		10 cm
	Price / piece		Price / piece		Price / piece
<input type="checkbox"/> 37 02 055	97 €	<input type="checkbox"/> 37 03 006	114 €	<input type="checkbox"/> 37 02 022	25 €

Handlebar

Classic-Handlebar – Black (standard configuration, if nothing else stated)			Touring handlebar			Round handlebar			Multifunctional handlebar suitable for 20" – 26"		
	Standard for	Width		Width	Depth		Width	Depth		Width	Depth
Size 2	16"	49 cm	Size 1	55 cm	17 cm	Size 1	40 cm	17 cm	Size 1	61.5 cm	16.5 cm
Size 3	20"	52 cm	Size 2	58 cm	17 cm	Size 2	43 cm	21 cm	Size 2		
Size 4	24"+26"	58 cm				Size 3	48 cm	25 cm	Size 3		
Price / piece			Upcharge / piece			Upcharge / piece			Upcharge / piece		
<input type="checkbox"/> Size 2 (37 02 011) incl. <input type="checkbox"/> Size 3 (37 03 011) incl. <input type="checkbox"/> Size 4 (37 04 011) incl.			<input type="checkbox"/> Size 1 (37 01 012) 98 € <input type="checkbox"/> Size 2 (37 02 012) 98 €			<input type="checkbox"/> Size 1 (37 01 013) 98 € <input type="checkbox"/> Size 2 (37 02 013) 98 € <input type="checkbox"/> Size 3 (37 03 013) 98 €			<input type="checkbox"/> 37 02 014 150 €		

Accessories

Push bar for attendant height adjustable and removable with integrated twist lock		Brake for attendant – incl. motor switch-off (can only be used in connection with push bar)	
	Price / piece		Price / piece
<input type="checkbox"/> for all sizes (36 00 012)	158 €	<input type="checkbox"/> 36 08 012	105 €

Crank

Progressively adjustable crank reducer without widening the pedal distance 	Crank reducer – minimal pedal distance widening, reduction in size by 2.5 or 5 cm respectively 	Special crank for knee contracture for 20° – 26° 
Price / pair	Price / pair	Price / piece
<input type="checkbox"/> for 16"+20" (37 00 016) 156 € <input type="checkbox"/> for 24"+26" (37 04 016) 156 €	<input type="checkbox"/> for 16"+20" (37 02 015) 80 € <input type="checkbox"/> for 24"+26" (37 05 015) 80 €	<input type="checkbox"/> mounted on right (37 03 015) 332 € <input type="checkbox"/> mounted on left (37 04 015) 332 €

Pedals
Foot cups

Foot fixing pedals – with racing hooks and compensation weights 	Home exerciser pedals 	Foot cups – width adjustable, with fixing straps 																								
Depth	Width	<table border="1"> <thead> <tr> <th></th> <th>Min. front width</th> <th>Max. front width</th> <th>Min. rear width</th> <th>Max. rear width</th> <th>Length</th> </tr> </thead> <tbody> <tr> <td>Size 1</td> <td>8.7 cm</td> <td>10.4 cm</td> <td>5.7 cm</td> <td>7.4 cm</td> <td>17.4 cm</td> </tr> <tr> <td>Size 2</td> <td>9.5 cm</td> <td>12 cm</td> <td>6.7 cm</td> <td>9.2 cm</td> <td>20.1 cm</td> </tr> <tr> <td>Size 3</td> <td>11.5 cm</td> <td>14 cm</td> <td>8.1 cm</td> <td>10.6 cm</td> <td>23.8 cm</td> </tr> </tbody> </table>		Min. front width	Max. front width	Min. rear width	Max. rear width	Length	Size 1	8.7 cm	10.4 cm	5.7 cm	7.4 cm	17.4 cm	Size 2	9.5 cm	12 cm	6.7 cm	9.2 cm	20.1 cm	Size 3	11.5 cm	14 cm	8.1 cm	10.6 cm	23.8 cm
	Min. front width	Max. front width	Min. rear width	Max. rear width	Length																					
Size 1	8.7 cm	10.4 cm	5.7 cm	7.4 cm	17.4 cm																					
Size 2	9.5 cm	12 cm	6.7 cm	9.2 cm	20.1 cm																					
Size 3	11.5 cm	14 cm	8.1 cm	10.6 cm	23.8 cm																					
13 cm	12 cm																									
Upcharge / pair	Upcharge / pair	Price / pair																								
<input type="checkbox"/> 37 00 013 84 €	<input type="checkbox"/> 37 00 014 58 €	<input type="checkbox"/> Size 1 (37 01 017) 197 € <input type="checkbox"/> Size 2 (37 02 017) 197 € <input type="checkbox"/> Size 3 (37 04 017) 197 €																								

Foot cups with leg guidance

Foot cups with leg guidance – width adjustable and with fixing straps									
	Min. front width	Max. front width	Min. rear width	Max. rear width	Length	Min. height guide height	Max. height guide height		
Size 1	8.7 cm	10.4 cm	5.7 cm	7.4 cm	17.4 cm	15 cm	18.5 cm		
Size 2	9.5 cm	12 cm	6.7 cm	9.2 cm	20.1 cm	18 cm	22 cm		
Size 3	11.5 cm	14 cm	8.1 cm	10.6 cm	23.8 cm	21 cm	26 cm		
Size 4	11.5 cm	14 cm	8.1 cm	10.6 cm	23.8 cm	28 cm	36 cm		
								Price / pair	
<input type="checkbox"/> Size 1 (37 01 018) <input type="checkbox"/> Size 2 (37 02 018) <input type="checkbox"/> Size 3 (37 03 018) <input type="checkbox"/> Size 4 (37 04 018)								334 €	
								334 €	
								334 €	
								334 €	

Foot cups with dynamic leg guidance

Foot cups with dynamic leg guidance width adjustable and with fixing straps									
	Min. front width	Max. front width	Min. rear width	Max. rear width	Length	Min. height guide height	Max. height guide height		
Size 1	8.7 cm	10.4 cm	5.7 cm	7.4 cm	17.4 cm	15 cm	18.5 cm		
Size 2	9.5 cm	12 cm	6.7 cm	9.2 cm	20.1 cm	18 cm	22 cm		
Size 3	12 cm	15 cm	8.8 cm	11.8 cm	24 cm	20.5 cm	25.5 cm		
								Price / pair	
<input type="checkbox"/> Size 1 (37 01 035) <input type="checkbox"/> Size 2 (37 02 035) <input type="checkbox"/> Size 3 (37 03 035)								437 €	
								437 €	
								437 €	



wave.

The bathing and shower cradle.

Further information can be found from page 146.



momo therapy bike.

Invoice address:**Dispatch address:**
 See invoice address

 Order
 Cost estimate

Customer No.: _____

Orderer: _____

Date: _____

Signature: _____

Commission:**The therapy bike for more balance.**

- Aluminium frame with extra-low access point
- Rim brake with separate parking brake
- Angle adjustable handlebar stem
- Steering damper for stabilisation when moving straight on
- Drum brake in front wheel
- Stabiliser frame with dynamic supports and adjustable spring strength
- Incl. luggage carrier

HMV-No.: 22.51.01.0014

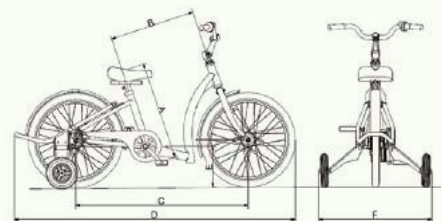

Dimensions - basic model

		12"	16"	20"	24"	26"
A*	Pedal to upper edge of saddle	30 - 38 cm	42 - 57.5 cm	50 - 64.5 cm	59 - 76.5 cm	71.5 - 87.5 cm
A**	Pedal to upper edge of saddle	33 - 41 cm	45 - 60 cm	52 - 68 cm	61 - 84 cm	73 - 95 cm
B	Saddle support tube to front tube	33 cm	39 cm	45 cm	53 cm	58 cm
C	Wheelbase	64 cm	76 cm	89 cm	104 cm	112 cm
D	Total length	99 cm	122 cm	148 cm	168 cm	178 cm
E	Access point height	16 cm	18 cm	20 cm	22 cm	23 cm
F	Total width	43 cm	52 cm	62 cm	71 cm	76 cm
	Max. load	35 kg	50 kg	65 kg	100 kg	100 kg
	Weight	10.5 kg	13 kg	15 kg	18 kg	20 kg



* Dimensions with standard saddle post / ** Dimensions with T-saddle post



Basic model									
momo therapy bike. 12"		momo therapy bike. 16"		momo therapy bike. 20"		momo therapy bike. 24"		momo therapy bike. 26"	
Basic features, without drum brake		Basic features		Basic features		Basic features, additional lighting system according to StVZO		Basic features, additional lighting system according to StVZO	
Price / piece		Price / piece		Price / piece		Price / piece		Price / piece	
<input type="checkbox"/> 38 01 000	1.018 €	<input type="checkbox"/> 38 02 000	1.142 €	<input type="checkbox"/> 38 03 000	1.245 €	<input type="checkbox"/> 38 04 000	1.490 €	<input type="checkbox"/> 38 05 000	1.490 €

Frame colours					
Colour selection for 12"		Colour selection for 16"+20"		Colour selection for 24"+26"	
					
Price		Price		Price	
<input type="checkbox"/> Telemagenta (Pink) (92 00 012)	incl.	<input type="checkbox"/> Melon yellow (92 00 006)	incl.	<input type="checkbox"/> Anthracit metallic (92 00 014)	incl.
<input type="checkbox"/> Sky blue (92 00 013)	incl.	<input type="checkbox"/> Marine blue (92 00 008)	incl.	<input type="checkbox"/> Pure white (92 00 100)	incl.
<input type="checkbox"/> Pure white (92 00 100)	incl.	<input type="checkbox"/> Pure white (92 00 100)	incl.		

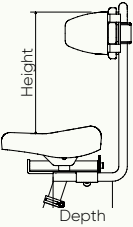

Configuration possibilities - drive			
	Art.-No.	Drive	Upcharge / piece
	<input type="checkbox"/> 38 00 001	Rigid sprocket (Standard configuration, if nothing else stated)	incl.
	<input type="checkbox"/> 38 00 101	Freewheel brake hub (with back pedal brake)	incl.
	<input type="checkbox"/> 38 00 002	Extra light transmission (only for above drive types)	incl.
	<input type="checkbox"/> 38 00 003	3-gear freewheel brake hub (with back pedal brake)	199 €
	<input type="checkbox"/> 38 00 007	3-gear freewheel brake hub with reverse option	286 €
	<input type="checkbox"/> 38 00 005	7-Gang-Freewheel brake hub (with back pedal brake)	330 €
	<input type="checkbox"/> 38 00 008	7-gear-freewheel hub with roll brake (Brake lever mounted on the handlebar, without back pedal brake)	475 €

Saddle																						
Standard saddle (standard configuration, if nothing else stated)							Gel saddle								Saddle seat with leg hollows							
	Width	Length		Rear width	Front width	Length		Rear width	Front width	Rear length	Total length		Rear width	Front width	Rear length	Total length						
Size 1	15cm	21cm					Size 1	19cm	4cm	24cm		Size 1	20.5cm	4cm	9.5cm	14.5cm						
Size 2	15cm	24cm		Size 1			Size 2	24cm	7cm	27cm		Size 2	24cm	4cm	9.5cm	14.5cm						
Size 3	18cm	26cm																				
Price / piece			Upcharge / piece				Upcharge / piece				Upcharge / piece											
<input type="checkbox"/> Size 1 (37 01 001)		incl.	<input type="checkbox"/> Size 1 (37 01 024)			50 €	<input type="checkbox"/> Size 1 (37 01 003)					191 €	<input type="checkbox"/> Size 1 (37 01 003)				191 €					
<input type="checkbox"/> Size 2 (37 02 001)		incl.	<input type="checkbox"/> Size 2 (37 02 024)			50 €	<input type="checkbox"/> Size 2 (37 02 003)					191 €	<input type="checkbox"/> Size 2 (37 02 003)				191 €					
<input type="checkbox"/> Size 3 (37 03 001)		incl.																				

Saddle								Saddle supports																							
Unicycle saddle – Banana shape (caution: min. inside leg length increases by 2 cm)								Moped saddle (caution: min. inside leg length increases by 2 cm)								Standard saddle support (standard configuration, if nothing else stated)								T-saddle support – for horizontal saddle adjustment							
Rear width	Middle width	Front width	Length	Rear width	Front width	Rear length	Total length		for				for																		
11cm	6cm	8cm	25cm	26cm	9.5cm	12cm	25cm		Size 1	12"			Size 1	12"																	
									Size 2	16"			Size 2	16"+20"																	
									Size 3	20"-26"			Size 3	24"+26"																	
Upcharge / piece				Upcharge / piece				Price / piece				Upcharge / piece																			
<input type="checkbox"/> 37 00 010			93 €	<input type="checkbox"/> 37 00 023			139 €	<input type="checkbox"/> Size 1 (37 01 004)			incl.	<input type="checkbox"/> Size 1 (37 01 005)				73 €															
								<input type="checkbox"/> Size 2 (37 02 004)			incl.	<input type="checkbox"/> Size 2 (37 02 005)				73 €															
								<input type="checkbox"/> Size 3 (37 03 004)			incl.	<input type="checkbox"/> Size 3 (37 03 005)				73 €															

Holding brackets				Headrest		
Holding brackets incl. holder – only for use together with the T-saddle support				Headrest – only for use together with a holding bracket		
	max. Height*	Depth	 		Width	Height
Size 1	20 cm	12 cm				
Size 2	30 cm	12 cm				
Size 3	37 cm	12 cm				
Size 4	53 cm	12 cm				
Tailored	___ cm (Max. 85 cm)	___ cm (Max. 30 cm)				
* Max. height: measured from the standard saddle to the top edge of the respective support pad						
				Price / set		Price / piece
<input type="checkbox"/> Size 1	(37 01 007)		114 €	<input type="checkbox"/> Size 1	(37 01 029)	303 €
<input type="checkbox"/> Size 2	(37 02 007)		114 €	<input type="checkbox"/> Size 2	(37 02 029)	303 €
<input type="checkbox"/> Size 3	(37 03 007)		114 €			
<input type="checkbox"/> Size 4	(37 04 007)		114 €			
<input type="checkbox"/> Tailored	(37 09 007)		240 €			

Torso supports				Pelvic supports				
Dynamic back support pad padded with strap and bracket (only for use together with a holding bracket)		Width adjustable back support pad padded. incl. bracket (only for use together with a holding bracket)		Dynamic pelvic guide support pad padded with strap and bracket (only for use together with a holding bracket)		Width adjustable pelvic guide support pad – padded. incl. bracket (only for use together with a holding bracket)		
								
	Width		Width		Width		Width	
Size 1	20 - 30 cm	Size 1	20 - 28 cm	Size 1	20 - 30 cm	Size 1	20 - 28 cm	
Size 2	25 - 35 cm	Size 2	25 - 33 cm	Size 2	25 - 35 cm	Size 2	25 - 33 cm	
Size 3	30 - 40 cm	Size 3	30 - 36 cm	Size 3	30 - 40 cm	Size 3	30 - 36 cm	
Price / piece		Price / piece		Price / piece		Price / piece		
<input type="checkbox"/> Size 1	(37 01 008)	213 €	<input type="checkbox"/> Size 1	(37 01 025)	286 €	<input type="checkbox"/> Size 1	(37 01 026)	286 €
<input type="checkbox"/> Size 2	(37 02 008)	213 €	<input type="checkbox"/> Size 2	(37 02 025)	286 €	<input type="checkbox"/> Size 2	(37 02 026)	286 €
<input type="checkbox"/> Size 3	(37 03 008)	213 €	<input type="checkbox"/> Size 3	(37 03 025)	286 €	<input type="checkbox"/> Size 3	(37 03 026)	286 €

Harness system								
Chest strap – for width adjustable back support pad				Positioning jacket – for width adjustable back support pad, incl. Universal bracket				
								
	Width	Length		Inside width	Total width	Side height	Total height	
Size 1	5 cm	18.5 cm		Size 1	8 cm	25 cm	10 cm	28 cm
Size 2	6.5 cm	25.5 cm		Size 2	9 cm	30 cm	12 cm	30 cm
Size 3	7 cm	30.5 cm		Size 3	12 cm	34 cm	16 cm	35 cm
Price / piece				Price / piece				
<input type="checkbox"/> Size 1	(37 01 050)		86 €	<input type="checkbox"/> Size 1	(37 01 051)		213 €	
<input type="checkbox"/> Size 2	(37 02 050)		86 €	<input type="checkbox"/> Size 2	(37 02 051)		213 €	
<input type="checkbox"/> Size 3	(37 03 050)		86 €	<input type="checkbox"/> Size 3	(37 03 051)		213 €	

Harness system

T-shape groin harness – for width adjustable pelvic support pad					4-point pelvic harness – for width adjustable pelvic support pad						
	Width of seat	Front width	Length of seat	Total length			Width of outer parts	Width of centre section	Outer part length	Centre section length	
Size 1	24 cm	23 cm	15 cm	32 cm		Size 1	7 cm	7 cm	12 cm	12 cm	
Size 2	26 cm	26 cm	17 cm	34 cm		Size 2	9 cm	8,5 cm	13 cm	14 cm	
Size 3	28 cm	28 cm	19 cm	38 cm		Size 3	11,5 cm	11 cm	15 cm	16 cm	
Price / piece					Price / piece						
<input type="checkbox"/> Size 1 (37 01 052) 146 € <input type="checkbox"/> Size 2 (37 02 052) 146 € <input type="checkbox"/> Size 3 (37 03 052) 146 €					<input type="checkbox"/> Size 1 (37 01 053) 150 € <input type="checkbox"/> Size 2 (37 02 053) 150 € <input type="checkbox"/> Size 3 (37 03 053) 150 €						

Accessories

Universal bracket for harness used without support pads (width = 27,5 cm)		Hand positioner – for all handlebars (if no quantity was specified: standard = 1 piece)		Steering stop – adjustable up to direction lock (incl. for steering for attendant)		Handlebar extension				
	Front width		Menge		for		Length			
	Size 0							8,5 cm	Size 1	12"
	Size 1							10 cm	Size 2	16"–26"
	Size 2							12 cm		
Size 3	14 cm									
Price / piece		Price / piece		Price / piece		Price / piece				
<input type="checkbox"/> 37 02 055 97 €		<input type="checkbox"/> Size 0 (37 00 054) 62 € <input type="checkbox"/> Size 1 (37 01 054) 62 € <input type="checkbox"/> Size 2 (37 02 054) 62 € <input type="checkbox"/> Size 3 (37 03 054) 62 €		<input type="checkbox"/> Size 1 (37 01 006) 114 € <input type="checkbox"/> Size 2 (37 03 006) 114 €		<input type="checkbox"/> Size 1 (37 01 022) 25 € <input type="checkbox"/> Size 2 (37 02 022) 25 €				



Handlebar

Classic handlebar – black (standard configuration, if nothing else stated)			Touring handlebar			Round handlebar			Multifunctional handlebar suitable for 20" – 26"												
	Standard for	Width		Width	Depth		Width	Depth		Width	Depth										
	Size 1	12"										47 cm	Size 1	55 cm	17 cm	Size 1	40 cm	17 cm	Size 1	61,5 cm	16,5 cm
	Size 2	16"										49 cm	Size 2	58 cm	17 cm	Size 2	43 cm	21 cm			
	Size 3	20"										52 cm				Size 3	48 cm	25 cm			
Size 4	24"+26"	58 cm																			
Price / piece			Upcharge / piece			Upcharge / piece			Upcharge / piece												
<input type="checkbox"/> Size 1 (37 01 011) incl. <input type="checkbox"/> Size 2 (37 02 011) incl. <input type="checkbox"/> Size 3 (37 03 011) incl. <input type="checkbox"/> Size 4 (37 04 011) incl.			<input type="checkbox"/> Size 1 (37 01 012) 98 € <input type="checkbox"/> Size 2 (37 02 012) 98 €			<input type="checkbox"/> Size 1 (37 01 013) 98 € <input type="checkbox"/> Size 2 (37 02 013) 98 € <input type="checkbox"/> Size 3 (37 03 013) 98 €			<input type="checkbox"/> 37 02 014 150 €												

Handlebar brake

Round handlebar with brake lever ring			Round handlebar with brake function – the brake function is simply activated by pressing down the round handlebars				
	Width	Depth		Width	Depth		
	Size 1	40 cm		17 cm	Size 1	40 cm	17 cm
	Size 2	43 cm		21 cm	Size 2	43 cm	21 cm
	Size 3	48 cm		25 cm	Size 3	48 cm	25 cm
Price / piece			Price / piece				
<input type="checkbox"/> Size 1 (37 01 028) 276 € <input type="checkbox"/> Size 2 (37 02 028) 276 € <input type="checkbox"/> Size 3 (37 03 028) 276 €			<input type="checkbox"/> Size 1 (37 01 031) 276 € <input type="checkbox"/> Size 2 (37 02 031) 276 € <input type="checkbox"/> Size 3 (37 03 031) 276 €				

Accessories

<p>Push bar height adjustable and removable, with integrated twist lock</p> 	<p>Parking brake for attendant (can only be used in connection with a push bar)</p> 	<p>Parking brake for attendant incl. motor switch-off when using the e-drive (can only be used in conjunction with Push bar)</p>	<p>Steering for attendant via deflection bar, incl. steering stop (can only be used in connection with a push bar)</p>
Price / piece	Price / piece	Price / piece	Price / piece
<input type="checkbox"/> for 12" (38 01 009) 158 € <input type="checkbox"/> for 16" (38 02 009) 158 € <input type="checkbox"/> for 20"-26" (38 03 009) 158 €	<input type="checkbox"/> 38 00 011 105 €	<input type="checkbox"/> 38 01 011 105 €	<input type="checkbox"/> for 12" (38 01 010) 398 € <input type="checkbox"/> for 16" (38 02 010) 398 € <input type="checkbox"/> for 20" (38 03 010) 398 €

Crank

<p>Progressively adjustable crank reducer without widening the pedal distance</p> 	<p>Crank reducer – minimal pedal distance widening, reduction in size by 2.5 or 5 cm respectively</p> 	<p>Special crank for knee contracture for 20" - 26"</p> 
Price / pair	Price / pair	Price / piece
<input type="checkbox"/> for 12"-20" (37 00 016) 156 € <input type="checkbox"/> for 24"+26" (37 04 016) 156 €	<input type="checkbox"/> for 16"+20" (37 02 015) 80 € <input type="checkbox"/> for 24"+26" (37 05 015) 80 €	<input type="checkbox"/> mounted on right (37 03 015) 332 € <input type="checkbox"/> mounted on left (37 04 015) 332 €

Pedals

<p>Foot fixing pedals – with racing hooks and compensation weights</p> 	<p>Home exerciser pedals</p> 	<p>Foot cups – width adjustable, with fixing straps</p> 
Upcharge / pair	Upcharge / pair	Price / pair
<input type="checkbox"/> 37 00 013 84 €	<input type="checkbox"/> 37 00 014 58 €	<input type="checkbox"/> Size 1 (37 01 017) 197 € <input type="checkbox"/> Size 2 (37 02 017) 197 € <input type="checkbox"/> Size 3 (37 04 017) 197 €

Foot cups with leg guidance								
Foot cups with leg guidance – width adjustable and with fixing straps								
	Min. front width	Max. front width	Min. rear width	Max. rear width	Length	Min. leg guide height	Max. leg guide height	
Size 1	8.7 cm	10.4 cm	5.7 cm	7.4 cm	17.4 cm	15 cm	18.5 cm	
Size 2	9.5 cm	12 cm	6.7 cm	9.2 cm	20.1 cm	18 cm	22 cm	
Size 3	11.5 cm	14 cm	8.1 cm	10.6 cm	23.8 cm	21 cm	26 cm	
Size 4	11.5 cm	14 cm	8.1 cm	10.6 cm	23.8 cm	28 cm	36 cm	
<input type="checkbox"/> Size 1 (37 01 018) <input type="checkbox"/> Size 2 (37 02 018) <input type="checkbox"/> Size 3 (37 03 018) <input type="checkbox"/> Size 4 (37 04 018)								334 € 334 € 334 € 334 €

Foot cups with dynamic leg guidance
Foot cups with dynamic leg guidance

width adjustable and with fixing straps

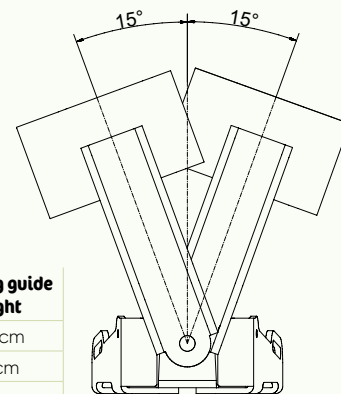

	Min. front width	Max. front width	Min. rear width	Max. rear width	Length	Min. leg guide height	Max. leg guide height
Size 1	8.7 cm	10.4 cm	5.7 cm	7.4 cm	17.4 cm	15 cm	18.5 cm
Size 2	9.5 cm	12 cm	6.7 cm	9.2 cm	20.1 cm	18 cm	22 cm
Size 3	12 cm	15 cm	8.8 cm	11.8 cm	24 cm	20.5 cm	25.5 cm

Price / pair

<input type="checkbox"/> Size 1 (37 01 035)	437 €
<input type="checkbox"/> Size 2 (37 02 035)	437 €
<input type="checkbox"/> Size 3 (37 03 035)	437 €

Configuration possibilities - lighting system

	Art.-No.	Lighting system	for	Upcharge / set
	<input type="checkbox"/> 38 01 021	Upgrade with a lighting system with side runners and reflectors according to StVZO	16"+20"	170 €
	<input type="checkbox"/> 38 02 021	Upgrade with a lighting system with hub dynamo and reflectors according to StVZO (not possible in conjunction with an electric drive)	16"+20"	286 €
	<input type="checkbox"/> 38 05 021	Lighting system in conjunction with an electric drive (this lighting system is already included on 24" + 26"-tricycles, which are ordered with an electric drive)	16"+20"	170 €
	<input type="checkbox"/> 38 03 021	Lighting system with hub dynamo (not possible in conjunction with an electric drive)	24"+26"	122 €

Accessories
Basket

Price / piece

<input type="checkbox"/> for 12"+16" (38 01 019)	50 €
<input type="checkbox"/> for 20"+24" (38 03 019)	50 €
<input type="checkbox"/> for 26" (38 05 019)	50 €

Quick connection of stabiliser frame – for simple disassembly for transport

Price / set

<input type="checkbox"/> for 12" (38 01 026)	118 €
<input type="checkbox"/> for 16" (38 02 026)	118 €
<input type="checkbox"/> for 20" (38 03 026)	118 €
<input type="checkbox"/> for 24" (38 04 026)	118 €
<input type="checkbox"/> for 26" (38 05 026)	118 €

Upgrade set
Stabiliser frame for third-party bicycles – with dynamic supports and adjustable spring strength

Price / set

<input type="checkbox"/> for 12" (38 01 101)	606 €
<input type="checkbox"/> for 16" (38 02 101)	606 €
<input type="checkbox"/> for 20" (38 03 101)	606 €
<input type="checkbox"/> for 24" (38 04 101)	663 €
<input type="checkbox"/> for 26" (38 05 101)	663 €
<input type="checkbox"/> Assembly at Schuchmann (38 00 025)	Net 145 €

E - drive
DirectPower E-drive from Heinzmann

The new **momo therapy bike** is equipped with the DirectPower E-drive from Heinzmann. This allows us to offer you a wear-free and silent direct drive. The motor is designed to be brushless and without gears. This minimises maintenance and wear and eliminates motor noise. The recuperative system automatically recharges when driving downhill or braking. This means that the range can be increased by up to 15 %. The existing force of the user is measured by a force sensor integrated in the bottom bracket, and the assistance from the electric drive is adjusted.

Choose the suitable E-drive for the **momo therapy bike** from the following configurations. You can choose whether the drive should be equipped **with or without start-up assistance**. In addition, you can choose between a **beginner version** and an **advanced version**. The difference here is the **start-up** and the **top speed** of the various modes **Eco**, **Standard** and **Power**, which can be selected via the display. An analysis cable can be used to change the selected version at a later date.



The e-drive excludes a rigid gear rim and brings with it an additional weight of approx. 10 kg.

E - drive configuration
DirectPower E-drive from Heinzmann – without start-up assistance

for size	Version	Start-up handling / top speed			Price / piece
		Eco	Standard	Power	
16"	<input type="checkbox"/> Beginner (38 02 085)	gentle / 4 km/h	medium / 4 km/h	strong / 6 km/h	2.540 €
	<input type="checkbox"/> Advanced (38 02 086)	medium / 6 km/h	strong / 8 km/h	strong / 10 km/h	2.540 €
20"	<input type="checkbox"/> Beginner (38 03 085)	gentle / 4 km/h	medium / 4 km/h	strong / 6 km/h	2.540 €
	<input type="checkbox"/> Advanced (38 03 086)	medium / 6 km/h	strong / 8 km/h	strong / 12 km/h	2.540 €
24"	<input type="checkbox"/> Beginner (38 04 085)	gentle / 6 km/h	medium / 8 km/h	strong / 12 km/h	2.540 €
	<input type="checkbox"/> Advanced (38 04 086)	gentle / 10 km/h	medium / 15 km/h	strong / 20 km/h	2.540 €
26"	<input type="checkbox"/> Beginner (38 05 085)	gentle / 6 km/h	medium / 8 km/h	strong / 12 km/h	2.540 €
	<input type="checkbox"/> Advanced (38 05 086)	gentle / 10 km/h	medium / 15 km/h	strong / 20 km/h	2.540 €

E - drive configuration
DirectPower E-drive from Heinzmann – with start-up assistance

Select whether the start-up assistance should be activated by pressing the button (**Fig. 1**) or by twist handle (**Fig. 2**).



for size	Version	Start-up assistance	Start-up handling / top speed			Price / piece
			Eco	Standard	Power	
16"	<input type="checkbox"/> Beginner with twist handle (38 02 087)	4 km/h	gentle / 4 km/h	medium / 4 km/h	strong / 6 km/h	2.643 €
	<input type="checkbox"/> Beginner with button (38 02 088)		2.643 €			
	<input type="checkbox"/> Advanced with twist handle (38 02 089)	6 km/h	medium / 6 km/h	strong / 8 km/h	strong / 10 km/h	2.643 €
	<input type="checkbox"/> Advanced with button (38 02 090)		2.643 €			
20"	<input type="checkbox"/> Beginner with twist handle (38 03 087)	4 km/h	gentle / 4 km/h	medium / 4 km/h	strong / 6 km/h	2.643 €
	<input type="checkbox"/> Beginner with button (38 03 088)		2.643 €			
	<input type="checkbox"/> Advanced with twist handle (38 03 089)	6 km/h	medium / 6 km/h	strong / 8 km/h	strong / 12 km/h	2.643 €
	<input type="checkbox"/> Advanced with button (38 03 090)		2.643 €			
24"	<input type="checkbox"/> Beginner with twist handle (38 04 087)	6 km/h	gentle / 6 km/h	medium / 8 km/h	strong / 12 km/h	2.643 €
	<input type="checkbox"/> Beginner with button (38 04 088)		2.643 €			
	<input type="checkbox"/> Advanced with twist handle (38 04 089)	6 km/h	gentle / 10 km/h	medium / 15 km/h	strong / 20 km/h	2.643 €
	<input type="checkbox"/> Advanced with button (38 04 090)		2.643 €			
26"	<input type="checkbox"/> Beginner with twist handle (38 05 087)	6 km/h	gentle / 6 km/h	medium / 8 km/h	strong / 12 km/h	2.643 €
	<input type="checkbox"/> Beginner with button (38 05 088)		2.643 €			
	<input type="checkbox"/> Advanced with twist handle (38 05 089)	6 km/h	gentle / 10 km/h	medium / 15 km/h	strong / 20 km/h	2.643 €
	<input type="checkbox"/> Advanced with button (38 05 090)		2.643 €			

Software
Subsequent conversion/adjustment of the software on the delivered product by our sales force

Net price (not discountable) / piece

 38 00 091 134 €

pipe.

The comfortable, foldable rehab buggy.

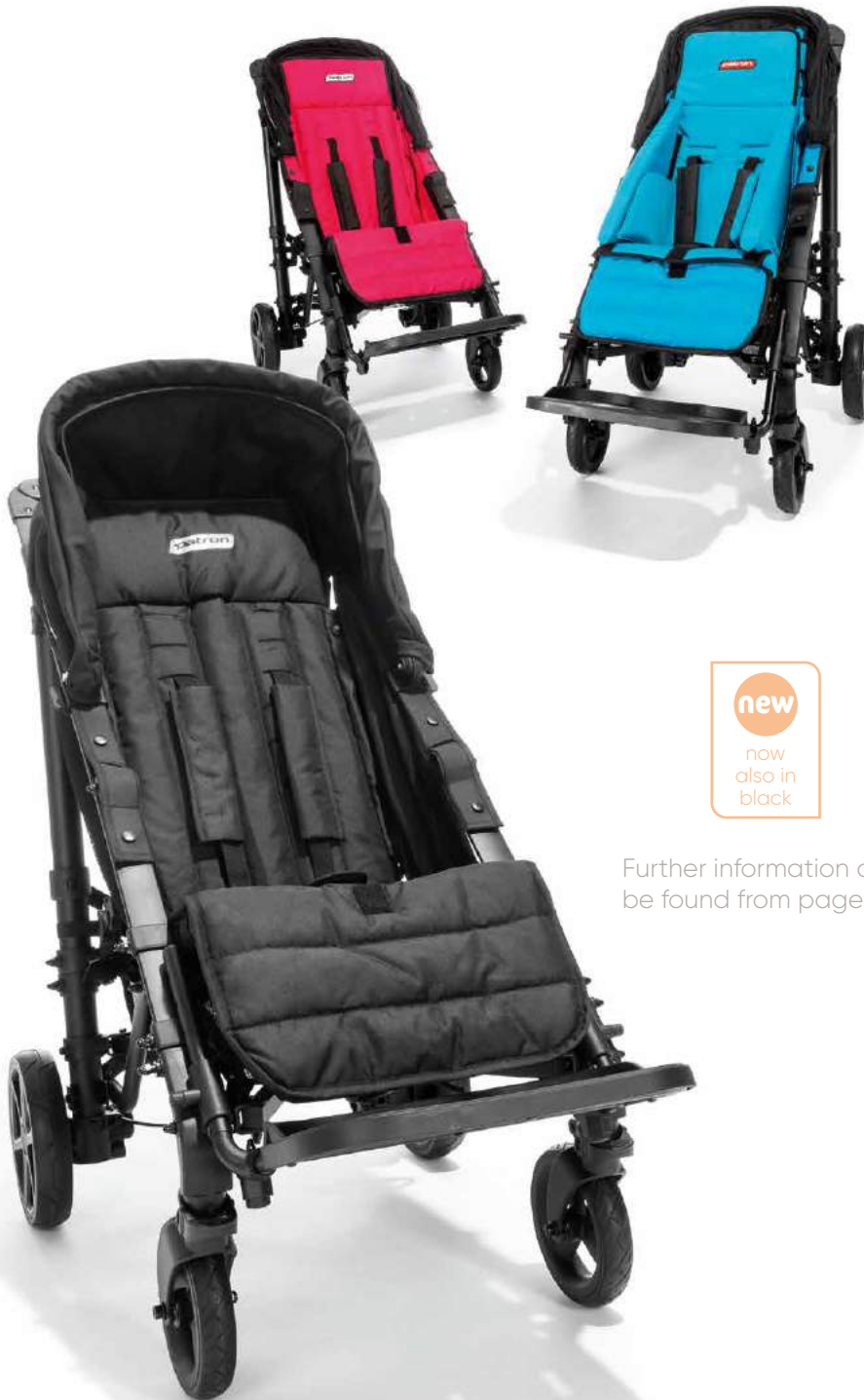

new
now
also in
black

Further information can
be found from page 80.

Invoice address:

Dispatch address: See invoice address

Order

Cost estimate

Customer No.: _____

Orderer: _____

Date: _____

Signature: _____

Commission:

The height adjustable supine standing frame.

- Height and angle adjustment (0-90°) via gas pressure spring for sizes 1+2
- Height and angle adjustment (0-90°) via electric power for sizes 3+4 (incl. safety shut-off and manual operation)
- Frame shaped to work with mobile hoists
- Upper body support adjustable in length, incl. padding elements to adjust the length of the upper body support
- Incl. chest strap and pelvic harness
- Adapter for leg rests (standard)
- Leg rests (standard), adjustable in length, with up to 5 cm pelvic rotation adjustment
- Split footrests (standard), which can be lowered to the floor via height adjustment of the center column
- Base frame with 5 (for size 1-3) or 6 (for size 4) castors (75 mm) with total locking devices, one of them with directional lock
- Frame colour: Telegrey 4 (white grey), attachment parts: black
- Incl. tool for all settings (adjustments can be made without tools)
- incl. push handles (size 3+4)

HMV-No.: 28.29.02.1xxx
(requested)

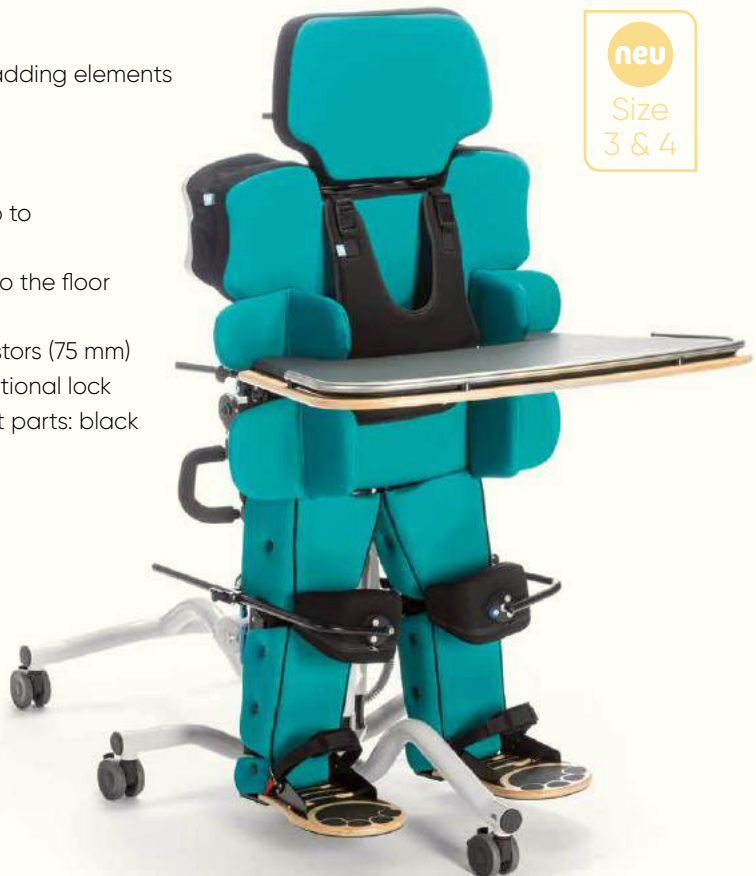

neu
Size
3 & 4

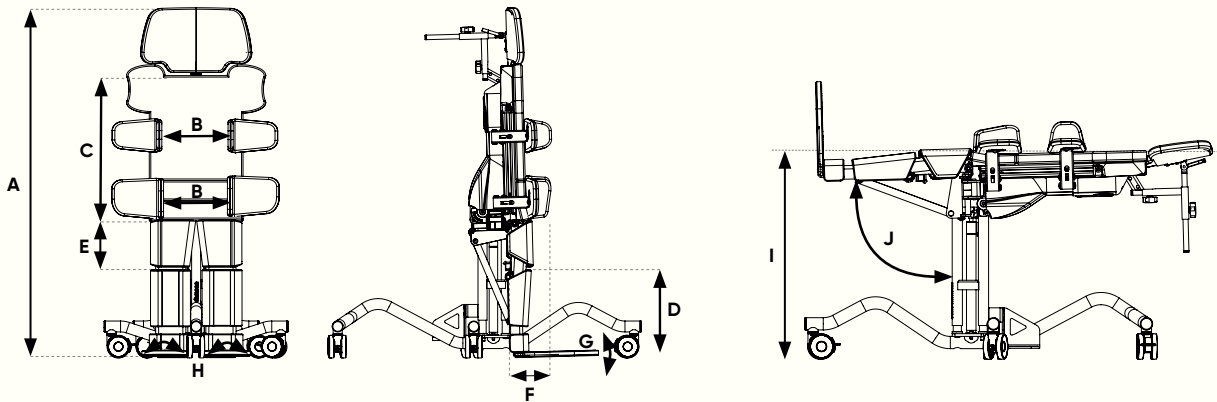
Dimensions

		Size 1	Size 2	Size 3	Size 4	
A	Body size	75 - 115cm	100 - 135cm	120 - 160cm	145 - 185cm	
B	Upper body support	Hip/thorax width	14 - 27cm	17 - 31cm	20 - 37cm	
C		Length	30.5 - 43cm	38 - 48cm	49 - 61cm	
D	Leg rests	Foot to knee	20.5 - 30.5cm	27.5 - 37cm	32.5 - 45cm	
E		Inside leg to knee	12 - 18.5cm	16.5 - 24cm	20 - 29.5cm	
		Knee angle	0° - 65°			
		Hip angle	0° - 45°			
		Abduction (each leg)	0° - 30°			
F		Pelvic rotation adjustment	0 - 5cm			
G	Feet	Dorsiflexion	0° - 20°			
G		Plantarflexion	0° - 15°			
H		Inversion/Eversion	0° - 15° each direction			
I	Height of lying surface (for transfer)	53.5 - 73.5cm	60 - 85cm	71.5 - 93.5cm	82.5 - 104.5cm	
J	Tilt	0° - 90°				
	Transport dimensions (LxWxH)	95x51x75cm	105x61x85cm	125x76x97cm	152x77x110cm	
	Max. load	30kg	60kg	80kg	100kg	
	Weight	30kg	35kg	80kg	90kg	

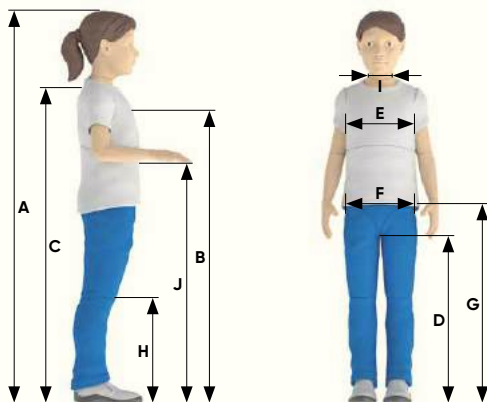
Settings

The following measurements should be pre-set on the standing frame:

A Body size	_____	F Pelvis width	_____
B Axilla height	_____	G Hip height	_____
C Shoulder height	_____	H Knee height	_____
D Inside leg height	_____	I Neck width	_____
E Chest width	_____	J Table height	_____

 42 00 020

Price

incl.

Basic model			
till. size 1 for users with a body size of 75 – 115 cm		till. size 2 for users with a body size of 100 – 135 cm	
with gas spring supported height and angle adjustment	with gas spring supported angle adjustment and power supported height adjustment (mains supply)	with gas spring supported height and angle adjustment	with gas spring supported angle adjustment and power supported height adjustment (mains supply)
Price / piece	Price / piece	Price / piece	Price / piece
<input type="checkbox"/> 42 01 000 2.240 €	<input type="checkbox"/> 42 01 100 3.890 €	<input type="checkbox"/> 42 02 000 2.430 €	<input type="checkbox"/> 42 02 100 4.080 €

Basic model			
till. size 3 for users with a body size of 120 – 160 cm		till. size 4 for users with a body size of 145 – 185 cm	
with power supported height and angle adjustment	with power supported height and angle adjustment and contourable upper body support (divided into shoulder, trunk and pelvis areas – areas can be individually fixed in the desired position with locking levers)	with power supported height and angle adjustment	with power supported height and angle adjustment and contourable upper body support (divided into shoulder, trunk and pelvis areas – areas can be individually fixed in the desired position with locking levers)
Price / piece	Price / piece	Price / piece	Price / piece
<input type="checkbox"/> 42 03 000 4.100 €	<input type="checkbox"/> 42 03 100 4.900 €	<input type="checkbox"/> 42 04 000 4.300 €	<input type="checkbox"/> 42 04 100 5.200 €

Covers for size 1+2		Covers for size 3+4		Fabric choice	
Black/Azur (No. 105 + 110)	Black/Pink 2 (No. 105 + 115)	Black/Petrol (No. 105 + 112)	Black/Dark grey (No. 105 + 92)	Fabric choice Please enter here the desired fabric out of our fabric collection: Art. No. (see page 156)	
				<hr/>	
Price	Price	Price	Price	Price	Price
<input type="checkbox"/> 91 00 233 incl.	<input type="checkbox"/> 91 00 234 incl.	<input type="checkbox"/> 91 00 237 incl.	<input type="checkbox"/> 91 00 236 incl.	<input type="checkbox"/> 91 00 999 incl.	

Headrests		
Headrest (standard) padded, incl. cover, height, depth and angle adjustment	Headrest (shell-shaped) padded, incl. cover, height, depth and angle adjustment	Headrest (lateral guide) padded, incl. cover, height, depth and angle adjustment
		
Price / piece	Price / piece	Price / piece
<input type="checkbox"/> for size 1 (42 01 001) 235 € <input type="checkbox"/> for size 2 (42 02 001) 235 € <input type="checkbox"/> for size 3+4 (42 03 001) 235 €	<input type="checkbox"/> for size 1 (42 01 003) 320 € <input type="checkbox"/> for size 2 (42 02 003) 320 € <input type="checkbox"/> for size 3+4 (42 03 003) 320 €	<input type="checkbox"/> for size 1 (42 01 002) 320 € <input type="checkbox"/> for size 2 (42 02 002) 320 € <input type="checkbox"/> for size 3+4 (42 03 002) 320 €

Headrests

Headrest (lateral guide, angle adjustable) – padded, incl. cover, height, depth and angle adjustable, side guides are each angle adjustable

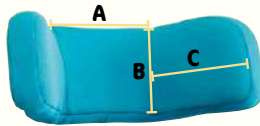

A = Width contact surface
B = Height headrest
C = Width lateral guide

	A	B	C
Size 1	13.5cm	10.5cm	10cm
Size 2	15cm	10.5cm	13.5cm
Size 3	17cm	12.5cm	16.5cm

	Price / piece
<input type="checkbox"/> Size 1 (42 01 033)	528 €
<input type="checkbox"/> Size 2 (42 02 033)	528 €
<input type="checkbox"/> Size 3 (42 03 033)	528 €

Universal adapter for tailored headrests
15x15mm, height and depth adjustable



	Price / piece
<input type="checkbox"/> 42 01 004	180 €

Support pads

Lateral pads for lying surface (standard)
incl. upper arm support, flip away, stepless adjustment for height and width, adjustable for rotation

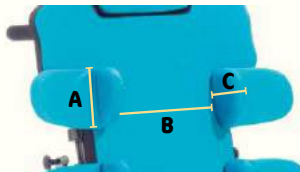

Pelvic pads for lying surface (standard)
incl. forearm rest, flip away, stepless adjustment for height and width, adjustable for rotation

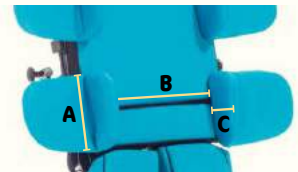

	Height (A)	Depth (C)	suitable for	Chest width (B)		Height (A)	Depth (C)	suitable for	Chest width (B)
Size 1	10.5cm	9cm	till. size 1	14 - 27cm	Size 1	12cm	9cm	till. size 1	14 - 27cm
			till. size 2	17 - 31cm				till. size 2	17 - 31cm
Size 2	11.5cm	11cm	till. size 2	17 - 31cm	Size 2	14cm	10.5cm	till. size 2	17 - 31cm
			till. size 3	20 - 37cm				till. size 3	20 - 37cm
Size 3	12.5cm	16cm	till. size 3	20 - 37cm	Size 3	17cm	15.5cm	till. size 3	20 - 37cm
			till. size 4	29 - 46cm				till. size 4	29 - 46cm
Size 4	13.5cm	18cm	till. size 3	20 - 37cm	Size 4	21cm	17.5cm	till. size 3	20 - 37cm
			till. size 4	27 - 46cm				till. size 4	27 - 46cm
					Price / pair				
<input type="checkbox"/> Size 1 (42 01 005)	265 €				<input type="checkbox"/> Size 1 (42 01 007)	265 €			
<input type="checkbox"/> Size 2 (42 02 005)	265 €				<input type="checkbox"/> Size 2 (42 02 007)	265 €			
<input type="checkbox"/> Size 3 (42 03 005)	265 €				<input type="checkbox"/> Size 3 (42 03 007)	265 €			
<input type="checkbox"/> Size 4 (42 04 005)	265 €				<input type="checkbox"/> Size 4 (42 04 007)	265 €			

Support pads



Knee support pads – individual three-dimensional adjustment, with patella recess and positioning aid



Knee support pads – individual three-dimensional adjustment, with adjustable padded support brackets and positioning aid

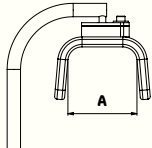
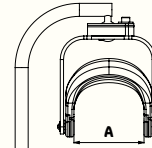

Padding – for additional support of the knee, to prevent hyperextension

	Inside width (A)		Inside width (A)		Length	Ø				
Size 1	8cm		Size 1	8cm			Size 1	8cm	4cm	
							Size 2	8cm	6cm	
							Size 3	10cm	8cm	
Size 4	12cm	10cm								
		Price / pair			Upcharge / pair			Price / piece		
<input type="checkbox"/> Size 1 (42 01 009)	470 €		<input type="checkbox"/> Size 1 (42 01 010)	530 €		<input type="checkbox"/> Size 1 (42 01 011)		145 €		
<input type="checkbox"/> Size 2 (42 02 009)	470 €		<input type="checkbox"/> Size 2 (42 02 010)	530 €		<input type="checkbox"/> Size 2 (42 02 011)		145 €		
<input type="checkbox"/> Size 3 (42 03 009)	470 €		<input type="checkbox"/> Size 3 (42 03 010)	530 €		<input type="checkbox"/> Size 3 (42 03 011)		145 €		
						<input type="checkbox"/> Size 4 (42 04 011)		145 €		

Accessories

for size 1+2



for size 3+4



Push bar

Safety bolt – for release lever, prevents unintentional release of height and angle adjustments (Note: only for size 1+2, not retrofittable!)



	Price / piece		Price / set
<input type="checkbox"/> for size 1+2 (42 01 012)	280 €	<input type="checkbox"/> 42 00 013	68 €
<input type="checkbox"/> for size 3+4 (42 03 012)	280 €		

Leg configuration

Adapter for leg rests (standard)
(standard configuration, if nothing else stated)



Adapter for leg rests (abduction)
enables individual and continuous abduction of each leg from 0° - 30° (Note: not retrofittable!)



Leg rests (standard) - length adjustable, with 5 cm pelvic rotation adjustment (standard configuration if nothing else stated)



Leg rests (flex) - adjustable in length and angle, with 5 cm pelvic rotation adjustment (Note: not retrofittable!)



Price		Upcharge		Price / pair		Upcharge / pair	
<input type="checkbox"/> for size 1+2 (42 01 014)	incl.	<input type="checkbox"/> for size 1+2 (42 01 015)	720 €	<input type="checkbox"/> for size 1 (42 01 016)	incl.	<input type="checkbox"/> for size 1 (42 01 017)	435 €
<input type="checkbox"/> for size 3+4 (42 03 014)	incl.	<input type="checkbox"/> for size 3+4 (42 03 015)	720 €	<input type="checkbox"/> for size 2 (42 02 016)	incl.	<input type="checkbox"/> for size 2 (42 02 017)	435 €
				<input type="checkbox"/> for size 3 (42 03 016)	incl.	<input type="checkbox"/> for size 3 (42 03 017)	435 €
				<input type="checkbox"/> for size 4 (42 04 016)	incl.	<input type="checkbox"/> for size 4 (42 04 017)	435 €

Foot configuration

Split footplates (standard)
(standard configuration if nothing else stated | Note: not retrofittable!)



Split footplates (flex) - individually adjustable, dorsiflex (20°), plantarflex (15°) and inversion/eversion (+/-15°) (Note: not retrofittable!)



Price / pair		Upcharge / pair	
<input type="checkbox"/> for size 1 (42 01 018)	incl.	<input type="checkbox"/> for size 1 (42 01 019)	220 €
<input type="checkbox"/> for size 2 (42 02 018)	incl.	<input type="checkbox"/> for size 2 (42 02 019)	220 €
<input type="checkbox"/> for size 3 (42 03 018)	incl.	<input type="checkbox"/> for size 3 (42 03 019)	220 €
<input type="checkbox"/> for size 4 (42 04 018)	incl.	<input type="checkbox"/> for size 4 (42 04 019)	220 €

Accessories

Heel edges - incl. belt + magnetic lock
(Note: cannot be combined with simple foot strap!)



Simple foot strap

Simple foot strap - with magnetic lock
(Note: cannot be combined with heel edges!)



Price / pair		Price / pair	
<input type="checkbox"/> for size 1 (42 01 021)	160 €	<input type="checkbox"/> for size 1 (42 01 022)	98 €
<input type="checkbox"/> for size 2 (42 02 021)	160 €	<input type="checkbox"/> for size 2 (42 02 022)	98 €
<input type="checkbox"/> for size 3 (42 03 021)	160 €	<input type="checkbox"/> for size 3 (42 03 022)	98 €
<input type="checkbox"/> for size 4 (42 04 021)	160 €	<input type="checkbox"/> for size 4 (42 04 022)	98 €

Therapy tray



Wood therapy tray with edge
removable, depth, height and angle adjustable

Price / piece	
<input type="checkbox"/> for size 1 (42 01 024)	680 €
<input type="checkbox"/> for size 2 (42 02 024)	680 €
<input type="checkbox"/> for size 3 (42 03 024)	680 €
<input type="checkbox"/> for size 4 (42 04 024)	680 €



Padded tray cover

covered with black wipe clean material, height: 1 cm

Price / piece	
<input type="checkbox"/> for size 1 (42 01 025)	142 €
<input type="checkbox"/> for size 2 (42 02 025)	142 €
<input type="checkbox"/> for size 3 (42 03 025)	142 €
<input type="checkbox"/> for size 4 (42 04 025)	142 €

Harness

Chest strap – with pad and adjustable clip on both sides (standard configuration if nothing else stated), colour: black



	Size 1	Size 2	Size 3
Pad width	4 cm	6 cm	6 cm
Pad length per side	18 cm	25 cm	30 cm
Strap length per side	25 cm	45 cm	65 cm
Strap width	2.5 cm	2.5 cm	2.5 cm

Price / piece

- Size 1 (**42 01 029**) incl.
 Size 2 (**42 02 029**) incl.
 Size 3 (**42 03 029**) incl.

Wide Chest strap – padded, colour: black



	Size 1	Size 2	Size 3
Pad width	8 cm	10 cm	12 cm
Polsterlänge	10 cm	25 cm	35 cm
Strap length per side	25 cm	45 cm	65 cm
Strap width	2.5 cm	2.5 cm	2.5 cm

Upcharge / piece

- Size 1 (**42 01 030**) 50 €
 Size 2 (**42 02 030**) 50 €
 Size 3 (**42 03 030**) 50 €

Harness

Positioning jacket – made of elastic, breathable and moisture repellent material, shoulder straps and pelvis straps (25 mm) with clips, colour: black

	A	B	C	D
Size 1	14 cm	26.5 cm	14 cm	33 cm
Size 2	15 cm	29.5 cm	16 cm	36 cm
Size 3	17 cm	35.5 cm	19 cm	41 cm
Size 4	18 cm	38.5 cm	21 cm	43.5 cm

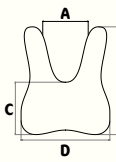

Extension for positioning jacket – for the belt attachment of the positioning jacket

recommended from a neck width of

for size 1	11 cm
for size 2	17 cm
for size 3	21 cm
for size 4	30 cm



Upcharge / piece

Price / set

- Size 1 (**42 01 027**) 206 €
 Size 2 (**42 02 027**) 206 €
 Size 3 (**42 03 027**) 206 €
 Size 4 (**42 04 027**) 206 €

- for size 1+2 **42 01 028** 48 €
 for size 3+4 **42 03 028** 48 €

Harness

Pelvic harness – with pad and adjustable clip on both sides (standard configuration if nothing else stated), colour: black



	Size 1	Size 2	Size 3
for pelvis width	16 – 25 cm	25 – 40 cm	38 – 46 cm
Pad width	4 cm	6 cm	6 cm
Pad length per side	18 cm	25 cm	30 cm
Strap length per side	25 cm	45 cm	65 cm
Strap width	2.5 cm	2.5 cm	2.5 cm

Price / piece

- Size 1 (**42 01 031**) incl.
 Size 2 (**42 02 031**) incl.
 Size 3 (**42 03 031**) incl.

Pelvic harness – by „Pelvi.Loc“, colour: black



	Size 1 (XS)	Size 2 (S)	Size 3 (M)	Size 4 (L)
for pelvis width	16 – 25 cm	25 – 34 cm	32 – 40 cm	38 – 46 cm
Pad width	6.5 cm	7 cm	7.5 cm	8.5 cm
Pad length per side	16 cm	19 cm	22 cm	24 cm
Strap length per side	25 cm	25 cm	45 cm	45 cm
Strap width	2.5 cm	2.5 cm	2.5 cm	2.5 cm

Upcharge / piece

- Size 1 (XS) (**42 01 032**) 265 €
 Size 2 (S) (**42 02 032**) 265 €
 Size 3 (M) (**42 03 032**) 265 €
 Size 4 (L) (**42 04 032**) 265 €

Accessories

Rechargeable battery (Li-Ion 2.25 Ah) – for basic models with power supported height adjustment (Note: can only be retrofitted by trained personnel)

Price / piece

- 42 01 026** 420 €



todd.

Invoice address:

Dispatch address: See invoice address

Order

Cost estimate

Customer No.: _____

Orderer: _____

Date: _____

Signature: _____

Commission:

The sporty and agile standing frame.

- **Basic frame (standard)** with height and depth adjustable footplate and four height adjustable support castors (75 mm), rear with springs and lock
- **Basic frame (with abduction)** with individual adjustable split footplate, two height adjustable support castors (75 mm) in the front and one support castor (30 mm) in the back
- Incl. chest support pad, rear support pad and three-dimensionally adjustable knee support pads with patella recess
- Mechanical angle adjustment of the central column from 0 - 15°
- Incl. drum brakes, easy operation via locking lever
- incl. table support and storage net (for size 3+4)
- Adjustable camber



HMV-No.: 28.29.01.3xxx

Please send us the following measurements for optimum presetting of the standing frame

Settings

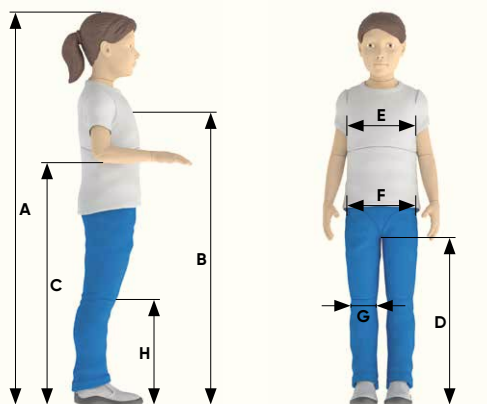

The following measurements should be pre-set on the standing frame:

A Body size	_____	H Knee height	_____
B Sternum height	_____	E Chest width	_____
C Elbow height	_____	F Pelvis width	_____
D Crotch height	_____	G Knee width	_____

49 00 020 Price incl.

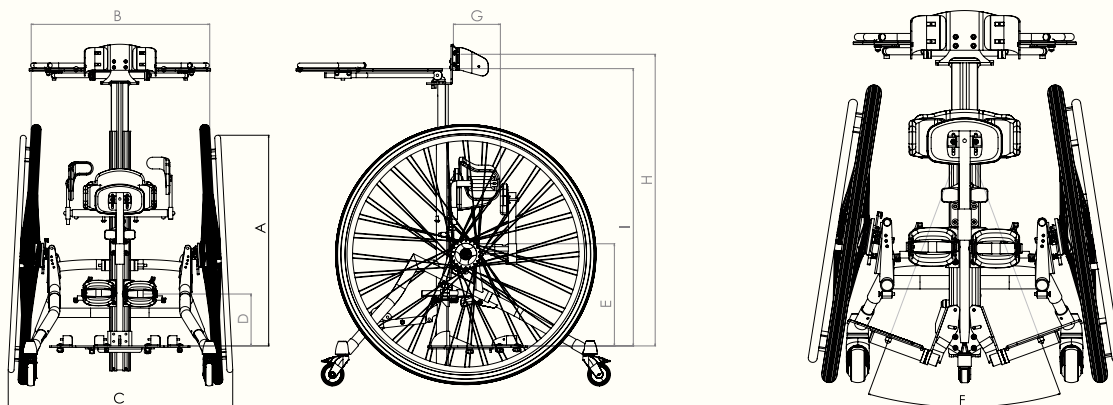
Dimensions







		Size 1		Size 2			Size 3		Size 4			
Body size		75 - 110 cm		100 - 130 cm			120 - 155 cm		150 - 175 cm			
Wheel size		24"	28"	30"	32"	36"	32"	36"	36"	40"	42"	
A	Grip height: footplate - hand rim at top	40 - 48 cm	50 - 58 cm	57 - 65 cm	64 - 69 cm	72 - 80 cm	60 - 68 cm	71 - 79 cm	82 - 90 cm	87 - 95 cm	87 - 95 cm	
	Recommended from elbow height	50 cm	60 cm	70 cm	80 cm	92 cm	82 cm	92 cm	92 cm	97 cm	99 cm	
B	Width of hand rim at top	0°	-	-	-	-	66 cm	66 cm	69 cm	69 cm	69 cm	
		3°	-	-	56 cm	55 cm	54 cm	62 cm	61 cm	65 cm	64 cm	63 cm
		6°	-	-	53 cm	51 cm	49 cm	58 cm	56 cm	61 cm	59 cm	58 cm
		9°	45 cm	44 cm	50 cm	47 cm	44 cm	55 cm	52 cm	57 cm	55 cm	53 cm
		12°	42 cm	41 cm	47 cm	43 cm	40 cm	-	-	-	-	-
		15°	40 cm	-	-	-	-	-	-	-	-	-
C	Width of hand rim at the bottom (min. - max.)	68 - 74 cm	70 - 73 cm	71 - 83 cm	71 - 83 cm	71 - 84 cm	73 - 83 cm	73 - 85 cm	76 - 86 cm	76 - 86 cm	76 - 90 cm	
D	Height from footplate to centre of knee support pads	19 - 30 cm		28 - 36 cm			34 - 44 cm		42 - 51 cm			
E	Height from footplate to support of buttocks support pad	26 - 42 cm		43 - 58 cm			53 - 69 cm		65 - 80 cm			
	Recommended for inside leg length	30 - 47 cm		48 - 63 cm			58 - 74 cm		70 - 84 cm			
F	Abduction split footplate	0° - 6°		0° - 6°			0° - 30°		0° - 30°			
F	Abduction split footplate (with abducted basic model)	0° - 40°		0° - 40°			-		-			
G	Pelvis dept*	11 - 24 cm		11 - 24 cm			15 - 28.5 cm		15 - 28.5 cm			
	Pelvis dept** (adjustment range of pelvis position via crank max. 6 cm)	11 - 20 cm (+6cm)		11 - 20 cm (+6cm)			15 - 27 cm (+6cm)		15 - 27 cm (+6cm)			
H	Sternum height (height from footplate to centre of chest support pad)	54 - 80 cm		68 - 101 cm			92 - 123 cm		111 - 140 cm			
I	Tray height from footplate	43 - 66 cm		61 - 79 cm			72 - 96 cm		92 - 110 cm			
	Max. load	30 kg		45 kg			65 kg		80 kg			

* with bracket for buttocks support pad (standard) ** with bracket for buttocks support pad (flip away)





Basic model





todd. size 1 For users with a body size 75 - 110 cm	todd. size 2 For users with a body size 110 - 130 cm	todd. size 3 For users with a body size 120 - 155 cm	todd. size 4 For users with a body size 150 - 175 cm
Price / piece	Price / piece	Price / piece	Price / piece
<input type="checkbox"/> Standard (4901000) 2.509 €	<input type="checkbox"/> Standard (4902000) 2.632 €	<input type="checkbox"/> Standard (4903000) 3.162 €	<input type="checkbox"/> Standard (4904000) 3.570 €
<input type="checkbox"/> Abductable (4901100) 2.815 €	<input type="checkbox"/> Abductable (4902100) 2.938 €		

Frame colours

Dormant red 	Melon yellow 	Turquoise blue 	Lasurit blue metallic 	Anthracit metallic 	Pure white 
Price	Price	neu Price	Price	Price	Price
<input type="checkbox"/> 9200003 incl.	<input type="checkbox"/> 9200006 incl.	<input type="checkbox"/> 9200016 incl.	<input type="checkbox"/> 9200010 incl.	<input type="checkbox"/> 9200014 incl.	<input type="checkbox"/> 9200100 incl.

Coated covers		Fabric choice	
Flexi Black		Flexi light grey	
<p>Fabric choice – please enter here the desired fabric out of our fabric collection: Art.-No. (see page 156) _____</p>			
	Price		Price
<input type="checkbox"/> 9100043	incl.	<input type="checkbox"/> 9100050	incl.
		<input type="checkbox"/> 9100999	incl.

Support pads				Accessories							
Chest system – adjustable in height			Chest support pad with lateral guide can be adjusted in height, width and depth			Chest support pad with lateral guide can be adjusted in height, width and depth, additionally angle adjustable			Back strap – with magnetic lock for chest support pad with lateral guide		
											
	Inside width	Height		Chest width					Pad width	Pad height	
Size 1	13 cm	27 cm	Size 1	16 – 24 cm	Size 1	16 – 24 cm	Size 1	17 cm	8.5 cm		
Size 2	16 cm	36 cm	Size 2	18 – 26 cm	Size 2	18 – 26 cm	Size 2	28 cm	10 cm		
Size 3	19 cm	43 cm	Size 3	24 – 34 cm	Size 3	24 – 34 cm	Size 3	39 cm	11.5 cm		
	Price / piece			Upcharge / piece			Upcharge / piece			Price / piece	
<input type="checkbox"/> Size 1 (4901001)	incl.		<input type="checkbox"/> Size 1 (4901002)	308 €		<input type="checkbox"/> Size 1 (4901003)	308 €		<input type="checkbox"/> Size 1 (4901024)	130 €	
<input type="checkbox"/> Size 2 (4902001)	incl.		<input type="checkbox"/> Size 2 (4902002)	308 €		<input type="checkbox"/> Size 2 (4902003)	308 €		<input type="checkbox"/> Size 2 (4902024)	130 €	
<input type="checkbox"/> Size 3 (4903001)	incl.		<input type="checkbox"/> Size 3 (4903002)	308 €		<input type="checkbox"/> Size 3 (4903003)	308 €		<input type="checkbox"/> Size 3 (4903024)	130 €	
			<input type="checkbox"/> Size 4 (4904002)	308 €		<input type="checkbox"/> Size 4 (4904003)	308 €				

Support pads				Accessories							
Knee support pads – individual three-dimensional adjustment, with patella recess			Knee support pads – individual three-dimensional adjustment, with adjustable attachment brackets (for knee bending and stretching)			Back support pad – only for use together with the buttocks support pad for the basic model size 1, 2 & 3			Headrest – can be adjusted in height, depth and angle, only for use together with the back support pad		
											
	Inside width			Inside width			Width	Height			
Size 1	8 cm		Size 1	8 cm	for size 1+2	20 cm	23 cm				
Size 2	10 cm		Size 2	10 cm	for size 3+4	25 cm	28 cm				
Size 3	12 cm		Size 3	12 cm							
	Price / pair			Upcharge / pair			Price / piece			Price / piece	
<input type="checkbox"/> Size 1 (4901011)	incl.		<input type="checkbox"/> Size 1 (4901012)	98 €		<input type="checkbox"/> for size 1 (4901025)	362 €		<input type="checkbox"/> for size 1 (4901026)	279 €	
<input type="checkbox"/> Size 2 (4902011)	incl.		<input type="checkbox"/> Size 2 (4902012)	98 €		<input type="checkbox"/> for size 2 (4902025)	362 €		<input type="checkbox"/> for size 2 (4902026)	279 €	
<input type="checkbox"/> Size 3 (4903011)	incl.		<input type="checkbox"/> Size 3 (4903012)	98 €		<input type="checkbox"/> for size 3+4 (4903025)	362 €		<input type="checkbox"/> for size 3 (4903026)	279 €	
									<input type="checkbox"/> for size 4 (4904026)	279 €	

Configuration possibilities - Bracket for buttock and pelvic positioning
Configuration 1:

Bracket for buttocks support pad (standard)
 depth adjustable via quick adjustment

	Depth adjustment Pelvic pad up to buttock pad	Standard configuration
Size 1	11 - 24 cm	for size 1+2
Size 2	15 - 28,5cm	for size 3+4
		Price / piece
<input type="checkbox"/> Size 1 (4901005)		incl.
<input type="checkbox"/> Size 2 (4903005)		incl.

Configuration 2:

Bracket for buttocks support pad (Flip away)

for step-by-step adjustment in the depth via hand crank and quick adjustment, fold-down mechanism for easier transfer (approx. 20 ° (10 cm) downwards)

	Depth adjustment Pelvic pad up to buttock pad	Depth adjustment via Crank	Standard configuration
Size 1	11 - 20 cm	6 cm	for size 1+2
Size 2	15 - 27 cm	6 cm	for size 3+4
			Upcharge / set
<input type="checkbox"/> Size 1 (4901004)			332 €
<input type="checkbox"/> Size 2 (4903004)			332 €

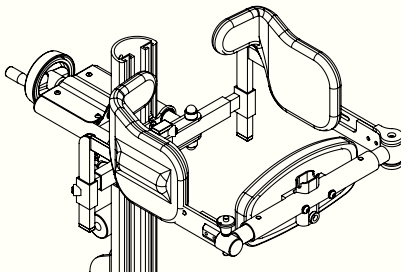
Configuration 3:

Pelvic frame (with swivel arm)

continuously adjustable in depth and width (depending on the configuration of the pads on page 130), additional depth adjustment by hand crank for gradual straightening of the user, incl. holder for buttocks support pad and back support pad



	Depth adjustment Pelvic pad up to buttock pad	Depth adjustment via Crank	
	11 - 24 cm	6 cm	
			Upcharge / set
<input type="checkbox"/> for size 1 (4901029)			440 €
<input type="checkbox"/> for size 2 (4902029)			440 €

Configuration possibilities - Pelvic positioning
Option 1:

Pelvis support pad with lateral guide (mounted at the front of the pelvis frame) + buttocks support pad (mounted at the back of the pelvis frame)

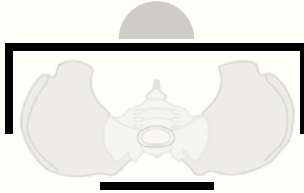
Pelvis support pad with lateral guide
width and depth adjustable



	Pelvis width	Depth adjustment
Size 1	16 - 24 cm	5 cm
Size 2	18 - 26 cm	5 cm
Size 3	24 - 34 cm	5 cm
Size 4	30 - 42 cm	5 cm
Price / piece		
<input type="checkbox"/> Size 1 (49 01 006)		342 €
<input type="checkbox"/> Size 2 (49 02 106)		342 €
<input type="checkbox"/> Size 3 (49 02 006)		342 €
<input type="checkbox"/> Size 4 (49 03 006)		342 €

Buttocks support pad

	Width x Height
Size 1	16 x 10 cm
Size 2	20 x 10 cm
Size 3	25 x 14 cm
Price / piece	
<input type="checkbox"/> Size 1 (49 01 007)	incl.
<input type="checkbox"/> Size 2 (49 02 007)	incl.
<input type="checkbox"/> Size 3 (49 03 007)	incl.

Option 2:

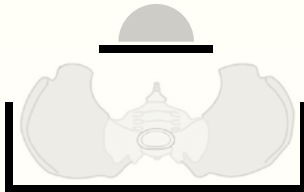
Pelvic positioner (mounted at the front of the pelvis frame) + pelvis support pad with lateral guide (mounted at the back of the pelvis frame)

Pelvic positioner – depth adjustable



	Width x Height	Depth adjustment
Size 1	16 x 10 cm	5 cm
Size 2	20 x 10 cm	5 cm
Size 3	25 x 14 cm	5 cm
Price / piece		
<input type="checkbox"/> Size 1 (49 01 008)		130 €
<input type="checkbox"/> Size 2 (49 02 008)		130 €
<input type="checkbox"/> Size 3 (49 03 008)		130 €

Pelvis support pad with lateral guide
width and depth adjustable

	Pelvis width
Size 1	16 - 24 cm
Size 2	18 - 26 cm
Size 3	24 - 34 cm
Size 4	30 - 42 cm
Upcharge / piece	
<input type="checkbox"/> Size 1 (49 01 010)	212 €
<input type="checkbox"/> Size 2 (49 02 110)	212 €
<input type="checkbox"/> Size 3 (49 02 010)	212 €
<input type="checkbox"/> Size 4 (49 03 010)	212 €

Option 3:

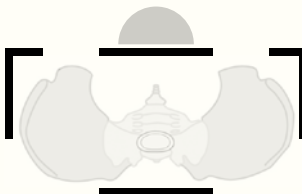
Pelvic positioner and combined spine and pelvic support pads (mounted at the front of the pelvis frame) + buttocks support pad (mounted at the back of the pelvis frame)

Pelvic positioner – depth adjustable

	Width x Height	Depth adjustment
Size 1	16 x 10 cm	5 cm
Size 2	20 x 10 cm	5 cm
Size 3	25 x 14 cm	5 cm
Price / piece		
<input type="checkbox"/> Size 1 (49 01 008)		130 €
<input type="checkbox"/> Size 2 (49 02 008)		130 €
<input type="checkbox"/> Size 3 (49 03 008)		130 €



Combined spine and pelvic support pads – width, depth and height adjustable

	Pelvis width	Depth adjustment
Size 1	16 - 26 cm	5 cm
Size 2	22 - 32 cm	5 cm
Size 3	32 - 42 cm	5 cm
Price / pair		
<input type="checkbox"/> Size 1 (49 01 009)		342 €
<input type="checkbox"/> Size 2 (49 02 009)		342 €
<input type="checkbox"/> Size 3 (49 03 009)		342 €

Buttocks support pad

	Width x Height
Size 1	16 x 10 cm
Size 2	20 x 10 cm
Size 3	25 x 14 cm
Price / piece	
<input type="checkbox"/> Size 1 (49 01 007)	incl.
<input type="checkbox"/> Size 2 (49 02 007)	incl.
<input type="checkbox"/> Size 3 (49 03 007)	incl.



Accessories

	Therapy tray – made of wood, with edge, incl. height adjustable attachment for chest support pad			Therapy tray with edge – made of Perspex, removable, not usable in combination with basket			
		Width		Depth		Width	Depth
	for size 3+4	70 cm		58 cm	for size 1+2	52 cm	40 cm
		Price / piece		for size 3+4	62 cm	50 cm	
<input type="checkbox"/> for size 3+4 (4903028)		332 €	<input type="checkbox"/> for size 1+2 (4901013)		332 €		
			<input type="checkbox"/> for size 3+4 (4903027)		332 €		



Accessories

	Basket – removable, not usable in combination with therapy tray			Mounting position of the brake – the brake lever can be mounted under the table on the left or right, as desired (standard configuration = under the table on the right)	
	Price / pair			Price	
<input type="checkbox"/> for size 1+2 4900014		145 €	<input type="checkbox"/> under table on left (4901015) incl.		332 €
			<input type="checkbox"/> under table on right (4902015) incl.		332 €



Rear wheels

Drive wheels – with drum brake, push rims and black PU tyres				Drive wheels with closed hand rim with drum brake and PU tyres			
		Price / pair for original equipment		Price / pair for original equipment		Price / pair for original equipment	
24" for size 1	<input type="checkbox"/> (4900016)	372 €	<input type="checkbox"/> (4900016 ET)	836 €	24" for size 1	<input type="checkbox"/> (4900017)	601 €
28" for size 1	<input type="checkbox"/> (4901016)	372 €	<input type="checkbox"/> (4901016 ET)	836 €	28" for size 1	<input type="checkbox"/> (4901017)	601 €
30" for Size 2	<input type="checkbox"/> (4902016)	445 €	<input type="checkbox"/> (4902016 ET)	1.265 €	30" for size 2	<input type="checkbox"/> (4902017)	668 €
32" for size 2+3	<input type="checkbox"/> (4903016)	445 €	<input type="checkbox"/> (4903016 ET)	1.265 €	32" for size 2+3	<input type="checkbox"/> (4903017)	668 €
36" for Size 2-4	<input type="checkbox"/> (4904016)	445 €	<input type="checkbox"/> (4904016 ET)	1.265 €	36" for size 2-4	<input type="checkbox"/> (4904017)	668 €
40" for size 4	<input type="checkbox"/> (4905016)	559 €	<input type="checkbox"/> (4905016 ET)	1.489 €	40" for size 4	<input type="checkbox"/> (4905017)	776 €
42" for size 4	<input type="checkbox"/> (4906016)	559 €	<input type="checkbox"/> (4906016 ET)	1.489 €			
		Price / pair for retrofitting		Price / pair for retrofitting		Price / pair for retrofitting	
						<input type="checkbox"/> (4900017 ET)	1.550 €
						<input type="checkbox"/> (4901017 ET)	1.550 €
						<input type="checkbox"/> (4902017 ET)	1.969 €
						<input type="checkbox"/> (4903017 ET)	1.969 €
						<input type="checkbox"/> (4904017 ET)	1.969 €
						<input type="checkbox"/> (4905017 ET)	2.285 €

Drive wheels

	Spoke guard – transparent			Wheel camber adjustment to set the hand rim width	
	Price / pair			Price	
<input type="checkbox"/> 24" for size 1 (4900018)		192 €	<input type="checkbox"/> 0° for size 3+4 (4900019)		incl.
<input type="checkbox"/> 28" for size 1 (4901018)		192 €	<input type="checkbox"/> 3° for size 2-4 (4901019)		incl.
<input type="checkbox"/> 30" for Size 2 (4902018)		192 €	<input type="checkbox"/> 6° for size 2-4 (4902019)		incl.
<input type="checkbox"/> 32" for size 2+3 (4903018)		279 €	<input type="checkbox"/> 9° for size 1-4 (4903019)		incl.
<input type="checkbox"/> 36" for size 3 (4904018)		279 €	<input type="checkbox"/> 12° for size 1+2 (4904019)		incl.
<input type="checkbox"/> 40" for size 4 (4905018)		342 €	<input type="checkbox"/> 15° for size 1 (4905019)		incl.

Accessories

Footplate – height and depth adjustable				Split footplate – individual height-, depth-, width- and angle adjustable				Heel edges with ankle straps – angle, width and depth adjustable, for mounting on the footrest(s) with magnetic locks	
		Price / piece				Upcharge / pair		Price / pair	
<input type="checkbox"/> for size 1 (4901020)		incl.	<input type="checkbox"/> for size 1 (4901021)		352 €	<input type="checkbox"/> Size 1 (4901027)		163 €	
<input type="checkbox"/> for size 2 (4902020)		incl.	<input type="checkbox"/> for size 2 (4902021)		352 €	<input type="checkbox"/> Size 2 (4902027)		163 €	
<input type="checkbox"/> for size 3 (4903020)		incl.	<input type="checkbox"/> for size 3+4 (4903021)		352 €				
<input type="checkbox"/> for size 4 (4904020)		incl.							

- Order**
- Cost estimate**

Customer No.: _____

Orderer: _____

Date: _____

Signature: _____

Invoice address:

Dispatch address: See invoice address

Commission:

The standing frame – from prone to supine.

- Basic frame with height and depth adjustable footplate
- Angular adjustment of the central column via gas pressure spring from (-) 15° - 30°
- Incl. chest support pad with lateral guide and buttocks support pad
- Height and depth adjustable pelvis frame, pelvis position adjustable via a crank
- Incl. three-dimensionally adjustable knee support pads with patella cutout
- Incl. therapy tray
- 4 castors with locking devices (75 mm) and total lock



HMV-No.: 28.29.02.1053

new Frame colour
Turquoise blue

Please send us the following measurements for optimum presetting of the standing frame

Settings

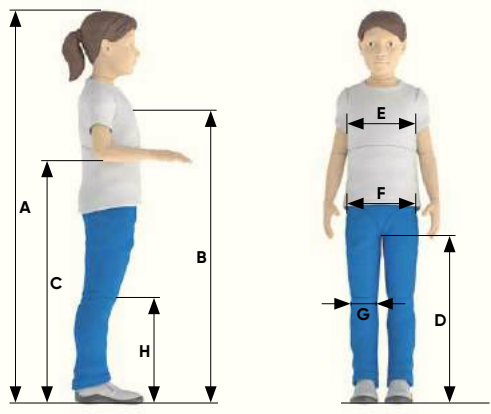

The following measurements should be pre-set on the standing frame:



A Body size _____	E Chest width _____
B Sternum height _____	F Pelvis width _____
C Elbow height _____	G Knee width _____
D Crotch height _____	H Knee height _____

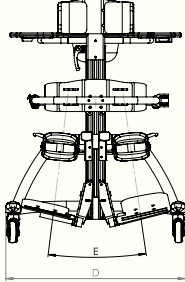
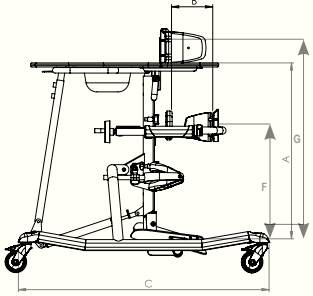

48 00 020 Price incl.

Dimensions				
		Size 1	Size 2	Size 3
	Body size	75 - 110 cm	100 - 140 cm	120 - 160 cm
A	Height from footplate to tray	48,5 - 80,5 cm	71 - 95 cm	80 - 112 cm
B	Pelvis depth	12 - 22 cm	16 - 28 cm	20 - 35 cm
	Depth adjustment of pelvis frame (via crank)	6 cm	6 cm	6 cm
C	Total length	84 cm	90 cm	100 cm
D	Total width	57 cm	65 cm	71 cm
E	Abduction divided footplate	0° - 27°	0° - 27°	0° - 27°
F	Pelvis height	45 - 60 cm	57 - 80 cm	65 - 90 cm
G	Sternum height	55 - 85 cm	75 - 110 cm	95 - 125 cm
	Max. load	40 kg	60 kg	80 kg

Basic model		
tim. size 1	tim. size 2	tim. size 3
For users with a body size 75 - 110 cm	For users with a body size 100 - 140 cm	For users with a body size 120 - 160 cm
Price / piece	Price / piece	Price / piece
<input type="checkbox"/> 48 01 100 2.964 €	<input type="checkbox"/> 48 02 100 2.964 €	<input type="checkbox"/> 48 03 100 3.207 €

Frame colours			
Colour selection for size 1	Colour selection for size 2	Colour selection for size 3	Coated with an individual colour (on request) Please provide the requested colour here: RAL _____
			
Price	Price	Price	Price
<input type="checkbox"/> Turquoise blue (92 00 016) incl. <input type="checkbox"/> Pure white (92 00 100) incl. <input type="checkbox"/> Melon yellow (92 00 006) incl.	<input type="checkbox"/> Turquoise blue (92 00 016) incl. <input type="checkbox"/> Pure white (92 00 100) incl. <input type="checkbox"/> Dormant Red (92 00 003) incl.	<input type="checkbox"/> Turquoise blue (92 00 016) incl. <input type="checkbox"/> Pure white (92 00 100) incl. <input type="checkbox"/> Lasurit blue metallic (92 00 010) incl.	<input type="checkbox"/> 48 00 090 incl.

Coated covers	Cover of choice
Flexi Black  Price <input type="checkbox"/> 91 00 043 incl.	Flexi Light grey  Price <input type="checkbox"/> 91 00 050 incl.
Fabric choice – please enter here the desired fabric out of our fabric collection: Art.-No. (see page 156) _____ Price <input type="checkbox"/> 91 00 999 incl.	

Lateral pads		Accessories	
Chest support pad with lateral guide can be adjusted in height, width and depth 	Chest support pad with lateral guide can be adjusted in height, width and depth, additionally angle adjustable 	Chin pad – height adjustable 	Back strap 
Chest width	Chest width	Inside width	Pad width Pad height
Size 1 16 - 24 cm	Size 1 16 - 24 cm	Size 1 6 cm	Size 1 17 cm 8.5 cm
Size 2 18 - 26 cm	Size 2 18 - 26 cm	Size 2 8 cm	Size 2 28 cm 10 cm
Size 3 24 - 34 cm	Size 3 24 - 34 cm	Size 3 10 cm	Size 3 39 cm 11.5 cm
Size 4 30 - 42 cm	Size 4 30 - 42 cm		
Price / piece	Upcharge / piece	Price / piece	Price / piece
<input type="checkbox"/> Size 1 (48 01 101) incl. <input type="checkbox"/> Size 2 (48 02 201) incl. <input type="checkbox"/> Size 3 (48 02 101) incl. <input type="checkbox"/> Size 4 (48 03 101) incl.	<input type="checkbox"/> Size 1 (48 01 102) 98 € <input type="checkbox"/> Size 2 (48 02 202) 98 € <input type="checkbox"/> Size 3 (48 02 102) 98 € <input type="checkbox"/> Size 4 (48 03 102) 98 €	<input type="checkbox"/> Size 1 (48 01 012) 217 € <input type="checkbox"/> Size 2 (48 02 012) 217 € <input type="checkbox"/> Size 3 (48 03 012) 217 €	<input type="checkbox"/> Size 1 (48 01 013) 130 € <input type="checkbox"/> Size 2 (48 02 013) 130 € <input type="checkbox"/> Size 3 (48 03 013) 130 €

Combinations - pelvic frame
Option 1:

Pelvis support pad with lateral guide (mounted at the front of the pelvis frame) + buttocks support pad (mounted at the back of the pelvis frame)

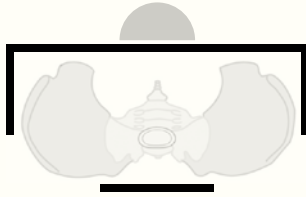
Pelvis support pad with lateral guide
width adjustable



	Pelvis width	Price / piece
Size 1	16 - 24 cm	342 €
Size 2	18 - 26 cm	342 €
Size 3	24 - 34 cm	342 €
Size 4	30 - 42 cm	342 €
		Price / piece
<input type="checkbox"/> Size 1 (48 01 005)		342 €
<input type="checkbox"/> Size 2 (48 02 105)		342 €
<input type="checkbox"/> Size 3 (48 02 005)		342 €
<input type="checkbox"/> Size 4 (48 03 005)		342 €

Buttocks support pad

	Width x Height	Price / piece
Size 1	16 x 10 cm	incl.
Size 2	20 x 10 cm	incl.
Size 3	25 x 14 cm	incl.
		Price / piece
<input type="checkbox"/> Size 1 (48 01 003)		incl.
<input type="checkbox"/> Size 2 (48 02 003)		incl.
<input type="checkbox"/> Size 3 (48 03 003)		incl.

Option 2:

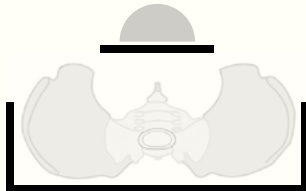
Pelvic positioner (mounted at the front of the pelvis frame) + pelvis support pad with lateral guide (mounted at the back of the pelvis frame)

Pelvic positioner



	Width x Height	Price / piece
Size 1	16 x 10 cm	130 €
Size 2	20 x 10 cm	130 €
Size 3	25 x 14 cm	130 €
		Price / piece
<input type="checkbox"/> Size 1 (48 01 004)		130 €
<input type="checkbox"/> Size 2 (48 02 004)		130 €
<input type="checkbox"/> Size 3 (48 03 004)		130 €

Pelvis support pad with lateral guide
width adjustable

	Pelvis width	Upcharge / piece
Size 1	16 - 24 cm	212 €
Size 2	18 - 26 cm	212 €
Size 3	24 - 34 cm	212 €
Size 4	30 - 42 cm	212 €
		Upcharge / piece
<input type="checkbox"/> Size 1 (48 01 006)		212 €
<input type="checkbox"/> Size 2 (48 02 106)		212 €
<input type="checkbox"/> Size 3 (48 02 006)		212 €
<input type="checkbox"/> Size 4 (48 03 006)		212 €

Option 3:

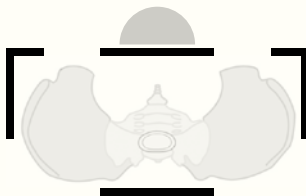
Pelvic positioner and combined spine and pelvic support pads (mounted at the front of the pelvis frame) + buttocks support pad (mounted at the back of the pelvis frame)

Pelvic positioner



	Width x Height	Price / piece
Size 1	16 x 10 cm	130 €
Size 2	20 x 10 cm	130 €
Size 3	25 x 14 cm	130 €
		Price / piece
<input type="checkbox"/> Size 1 (48 01 004)		130 €
<input type="checkbox"/> Size 2 (48 02 004)		130 €
<input type="checkbox"/> Size 3 (48 03 004)		130 €

Combined spine and pelvic support pads – width, depth and height adjustable





	Pelvis width	Price / pair
for size 1	16 - 26 cm	342 €
for size 2	22 - 32 cm	342 €
for size 3	32 - 42 cm	342 €
		Price / pair
<input type="checkbox"/> for size 1 (48 01 007)		342 €
<input type="checkbox"/> for size 2 (48 02 007)		342 €
<input type="checkbox"/> for size 3 (48 03 007)		342 €

Buttocks support pad

	Width x Height	Price / piece
Size 1	16 x 10 cm	incl.
Size 2	20 x 10 cm	incl.
Size 3	25 x 14 cm	incl.
		Price / piece
<input type="checkbox"/> Size 1 (48 01 003)		incl.
<input type="checkbox"/> Size 2 (48 02 003)		incl.
<input type="checkbox"/> Size 3 (48 03 003)		incl.

Support pads				Accessories			
Knee support pads – individual threedimensional adjustment, with patella recess		Knee support pads – individual threedimensional adjustment, with adjustable attachment brackets (for knee bending and stretching)		Back support pad – mounted at the back of the pelvis frame, height and angle adjustable		Headrest – height, depth and angle adjustable, only for use together with the back support pad	
	Inside width				Width	Height	
Size 1	8 cm		Size 1	8 cm	for size 1	20 cm	23 cm
Size 2	10 cm		Size 2	10 cm	for size 2	20 cm	23 cm
Size 3	12 cm		Size 3	12 cm	for size 3	25 cm	28 cm
Price / pair		Upcharge / pair		Price / piece		Price / piece	
<input type="checkbox"/> Size 1 (48 01 008)	incl.	<input type="checkbox"/> Size 1 (48 01 009)	98 €	<input type="checkbox"/> for size 1 (48 01 010)	362 €	<input type="checkbox"/> for size 1 (48 01 111)	279 €
<input type="checkbox"/> Size 2 (48 02 008)	incl.	<input type="checkbox"/> Size 2 (48 02 009)	98 €	<input type="checkbox"/> for size 2 (48 02 010)	362 €	<input type="checkbox"/> for size 2 (48 02 111)	279 €
<input type="checkbox"/> Size 3 (48 03 008)	incl.	<input type="checkbox"/> Size 3 (48 03 009)	98 €	<input type="checkbox"/> for size 3 (48 03 010)	362 €	<input type="checkbox"/> for size 3 (48 03 111)	279 €

Accessories							
Therapy tray	Therapy tray – with bowl (incl. cover)	Therapy tray – with adjustable armrests	Therapy tray – with adjustable armrests and bowl (incl. cover)				
							
Price / piece	Upcharge / piece	Upcharge / piece	Upcharge / piece				
<input type="checkbox"/> for size 1 (48 01 114)	incl.	<input type="checkbox"/> for size 1 (48 01 115)	217 €	<input type="checkbox"/> for size 1 (48 01 116)	187 €	<input type="checkbox"/> for size 1 (48 01 117)	404 €
<input type="checkbox"/> for size 2 (48 02 114)	incl.	<input type="checkbox"/> for size 2 (48 02 115)	217 €	<input type="checkbox"/> for size 2 (48 02 116)	187 €	<input type="checkbox"/> for size 2 (48 02 117)	404 €
<input type="checkbox"/> for size 3 (48 03 114)	incl.	<input type="checkbox"/> for size 3 (48 03 115)	217 €	<input type="checkbox"/> for size 3 (48 03 116)	187 €	<input type="checkbox"/> for size 3 (48 03 117)	404 €

Accessories			
Pad for therapy tray without armrests covered with black flexi cover, height: 1 cm	Pad for therapy tray with armrests covered with black flexi cover, height: 1 cm	Angular adjustment of the center column by gas spring from (-) 15° - 30° – (standard configuration = with foot pedal, if nothing else stated)	
			
Price / piece	Price / piece	Price / piece	
<input type="checkbox"/> for size 1 (48 01 018)	145 €	<input type="checkbox"/> by foot pedal on the base frame (48 00 025)	incl.
<input type="checkbox"/> for size 2 (48 02 018)	145 €	<input type="checkbox"/> by manual release under the table (48 01 025)	incl.
<input type="checkbox"/> for size 3 (48 03 018)	145 €		

Accessories			
Footplate – height and depth adjustable	Individual footplates – height, width and angle adjustable (abduction of legs)	Heel edges with ankle straps – angle, width and depth adjustable, for mounting on the footrest(s) with magnetic locks	
			
		Front width	
		Size 1	8.5 - 11 cm
		Size 2	10 - 12.5 cm
Price / piece	Upcharge / pair	Price / pair	
<input type="checkbox"/> for size 1 (48 01 120)	incl.	<input type="checkbox"/> Size 1 (48 01 024)	163 €
<input type="checkbox"/> for size 2 (48 02 120)	incl.	<input type="checkbox"/> Size 2 (48 02 024)	163 €
<input type="checkbox"/> for size 3 (48 03 120)	incl.		

hip.

 Order
 Cost estimate

Customer No.: _____

Orderer: _____

Date: _____

Signature: _____

Invoice address:
Dispatch address:
 See invoice address

Commission:
The comprehensive and hip standing trainer.

- Incl. support castors and individual adjustable split footplate
- Stepless height adjustable support pads
- Individually configurable
- Frame color: light ivory

HMV-No.: 28.29.01.1051

Dimensions		
	Size 1	Size 2
Body size	75 - 110cm	97 - 150cm
Height footplate – armpits	50 - 90cm	67 - 113cm
Height ground – footplate	9cm	10cm
Chest width	20 - 25cm	25 - 30cm
Tilt*	0° - 30°	0° - 30°
Total width	66cm	86cm
Total length	50cm	80cm
Max. load	40kg	60kg
Weight (without / with angular adjustment)	16kg / 18kg	22kg / 24kg

* only applies to the tilt-adjustable models

Please send us the following measurements for optimum presetting of the standing frame

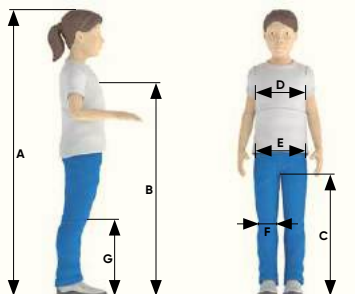
Settings

The following measurements should be pre-set on the standing frame:

A Body size	_____	E Pelvis width	_____
B Sternum height	_____	F Knee width	_____
C Crotch height	_____	G Knee height	_____
D Chest width	_____		

 46 00 020

Price

incl.

Basic model			
hip. size 1 fixed 	hip. size 2 fixed 	hip. size 1 tilt-adjustable 	hip. size 2 tilt-adjustable 
Price / piece	Price / piece	Price / piece	Price / piece
<input type="checkbox"/> 46 01 100 1.800 €	<input type="checkbox"/> 46 02 100 1.888 €	<input type="checkbox"/> 46 01 000 2.638 €	<input type="checkbox"/> 46 02 000 2.747 €

Support pads			
	Torso pelotte pad can be adjusted in height and width <div style="text-align: right;">Price / piece</div> <input type="checkbox"/> Size 1 - Black (46 01 002) 397 € <input type="checkbox"/> Size 1 - Red (46 01 102) 397 € <input type="checkbox"/> Size 2 - Black (46 02 002) 397 € <input type="checkbox"/> Size 2 - Red (46 02 102) 397 €		Torso pelotte pad with higher sternum surface can be adjusted in height and width <div style="text-align: right;">Price / piece</div> <input type="checkbox"/> Size 1 - Black (46 01 006) 493 € <input type="checkbox"/> Size 1 - Red (46 01 106) 493 € <input type="checkbox"/> Size 2 - Black (46 02 006) 493 € <input type="checkbox"/> Size 2 - Red (46 02 106) 493 €

Support pads			
Pelvic pelotte pad – can be adjusted in height and width  <div style="text-align: right;">Price / piece</div> <input type="checkbox"/> Size 1 - Black (46 01 003) 397 € <input type="checkbox"/> Size 1 - Red (46 01 103) 397 € <input type="checkbox"/> Size 2 - Black (46 02 003) 397 € <input type="checkbox"/> Size 2 - Red (46 02 103) 397 €	Height adjustment via quick release for torso and pelvic pelotte pad (consisting of 2 pieces)  <div style="text-align: right;">Price / set</div> <input type="checkbox"/> 46 00 011 163 €	Knee support pads – individual three-dimensional adjustment, with patella recess  <div style="text-align: right;">Price / pair</div> <input type="checkbox"/> Size 1 - Black (46 01 004) 264 € <input type="checkbox"/> Size 1 - Red (46 01 104) 264 € <input type="checkbox"/> Size 2 - Black (46 02 004) 264 € <input type="checkbox"/> Size 2 - Red (46 02 104) 264 €	Knee support pads – individual three-dimensional adjustment, with adjustable attachment brackets (for knee bending and stretching)  <div style="text-align: right;">Price / pair</div> <input type="checkbox"/> Size 1 (46 01 205) 300 € <input type="checkbox"/> Size 2 (46 02 205) 300 €

Cover		Accessories										
Cover made of Flexi (black) for pelvic support pad <div style="text-align: right;">Price / piece</div> <input type="checkbox"/> Size 1 (46 01 008) 97 € <input type="checkbox"/> Size 2 (46 02 008) 97 €	Cover made of Flexi (black) for pelvic support pad with higher sternum surface <div style="text-align: right;">Price / piece</div> <input type="checkbox"/> Size 1 (46 01 009) 129 € <input type="checkbox"/> Size 2 (46 02 009) 129 €	Therapy tray – with cover, height, depth and angle adjustable  <table border="1" style="float: right;"> <thead> <tr> <th></th> <th>Width</th> <th>Depth</th> </tr> </thead> <tbody> <tr> <td>Size 1</td> <td>50 cm</td> <td>21 cm</td> </tr> <tr> <td>Size 2</td> <td>70 cm</td> <td>30 cm</td> </tr> </tbody> </table> <div style="text-align: right;">Price / piece</div> <input type="checkbox"/> Size 1 with transparent cover (46 01 007) 434 € <input type="checkbox"/> Size 2 with transparent cover (46 02 007) 434 € <input type="checkbox"/> Size 2 with therapy well and white cover (46 02 107) 547 €		Width	Depth	Size 1	50 cm	21 cm	Size 2	70 cm	30 cm	
	Width	Depth										
Size 1	50 cm	21 cm										
Size 2	70 cm	30 cm										

Accessories		
Footplate  <div style="text-align: right;">Upcharge / piece</div> <input type="checkbox"/> Size 1 (46 01 010) 105 € <input type="checkbox"/> Size 2 (46 02 010) 105 €	Heel edges – angle, width and depth adjustable, for attachment on the (individual) footplate / split footplate  <div style="text-align: right;">Price / pair</div> <input type="checkbox"/> Size 1 (46 01 011) 84 € <input type="checkbox"/> Size 2 (46 02 011) 84 €	Ankle straps – with velcro and deflection roll (only possible together with the adjacent heel edges)  <div style="text-align: right;">Price / pair</div> <input type="checkbox"/> Size 1 (46 01 012) 38 € <input type="checkbox"/> Size 2 (46 02 012) 38 €

-
- Order**
-
-
- Cost estimate**

Customer No.: _____

Orderer: _____

Date: _____

Signature: _____

Invoice address:
Dispatch address:
 See invoice address

Commission:
The transfer and mobility device.

- Abductable frame
- Padded trunk support
- Electric height adjustment
- Push bar
- 2 leg straps
- Battery and charger
- 4 dual castors (2 with brakes)



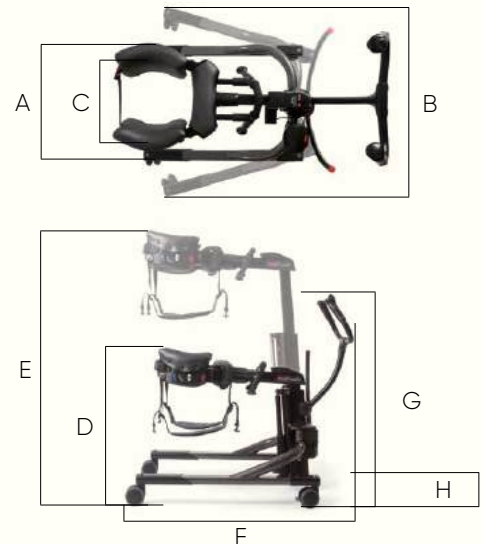

Dimensions

		tram.
A	Min. total width	70 cm
B	Max. total width	102 cm
C	Max. trunk support width	56 cm
D	Min. trunk support height	110 cm
E	Max. trunk support height	147 cm
F	Total length	116 cm
G	Push bar height	110 cm
H	Floor to top of base leg	low base 11 cm
		standard base 17.5 cm
	Girth	56 - 152 cm
	Turning diameter	127 cm
	Min. user armpit height	77 cm
	Max. user height	193 cm
	Weight	32 kg
	Max. load	158 kg

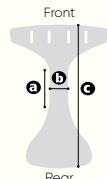

Basic model			
tram.		tram. with integrated scale	
		Price / piece	Price / piece
<input type="checkbox"/> Low base	(47 00 200) (K322+K304)	4.182 €	<input type="checkbox"/> Low base (47 00 300) (K321+K304) 4.998 €
<input type="checkbox"/> Standard base	(47 00 000) (K302+K304)	4.182 €	<input type="checkbox"/> Standard base (47 00 100) (K301+K304) 4.998 €

Accessories			
Arm prompts – incl. bracket 		Arm platforms – incl. bracket 	
	Padded surface	Adjustment range (elbow to fist)	
Size 1	B11xT17cm	20 – 31cm	
Size 2	B13xT21cm	26 – 40cm	
Price / pair		Price / pair	
<input type="checkbox"/> Size 1 (47 01 001) (K305)	567 €	<input type="checkbox"/> 47 00 007 (K397)	592 €
<input type="checkbox"/> Size 2 (47 02 001) (K315)	567 €		
		Pelvic support 	
		Range of circumference	
Size 1		20 – 40cm	
Size 2		40 – 70cm	
Size 3		50 – 90cm	
		Price / piece	
<input type="checkbox"/> Size 1 (47 01 002) (K306)		<input type="checkbox"/> Size 1 (47 01 002) (K306)	284 €
<input type="checkbox"/> Size 2 (47 02 002) (K316)		<input type="checkbox"/> Size 2 (47 02 002) (K316)	305 €
<input type="checkbox"/> Size 3 (47 03 002) (K326)		<input type="checkbox"/> Size 3 (47 03 002) (K326)	326 €

Accessories			
Thigh straps 		Seat belt 	
		Hip positioner – adjustable, incl. bracket 	
			
		Size 1	Size 2
		Crotch length (a)	6 cm 9 cm
		Width (b)	3 cm 4.5 cm
		Length (c)	23 cm 28 cm
Price / pair		Price / piece	
<input type="checkbox"/> Narrow (13 cm) (47 01 003) (K308) incl.	<input type="checkbox"/> Narrow (13 cm) (47 00 003) (K318) 84 €	<input type="checkbox"/> Size 1 (47 01 007) (K667)	530 €
<input type="checkbox"/> Wide (18 cm) (47 01 106) (K338) incl.	<input type="checkbox"/> Wide (18 cm) (47 00 106) (K328) 84 €	<input type="checkbox"/> Size 2 (47 02 007) (K668)	588 €
		Pad – for hip positioner 	
		Price / piece	
		<input type="checkbox"/> for size 1 (47 01 008) (K541)	191 €
		<input type="checkbox"/> for size 2 (47 02 008) (K542)	191 €

Accessories		
Switch pole – allows either the caregiver or client to operate the electric lift  		
Price / piece		
<input type="checkbox"/> 47 00 008 (K666)	286 €	
Additional battery 		
Price / piece		
<input type="checkbox"/> 47 00 004 (K307)	240 €	
Swivel lock  		
Price		
<input type="checkbox"/> 1 piece (47 05 005) (K323) for low version		95 €
<input type="checkbox"/> 1 piece (47 00 005) (K309) for tall version		95 €
<input type="checkbox"/> 1 pair (47 06 005) (K324) for low version		190 €
<input type="checkbox"/> 1 pair (47 01 005) (K319) for tall version		190 €

boris.

Invoice address:
Dispatch address:
 See invoice address

 Order
 Cost estimate

Customer No.: _____

Orderer: _____

Date: _____

Signature: _____

Commission:
The comfortable toilet and shower chair.

- Anatomically-shaped seat pan made of PE, colour steel blue
- Subframe made of stainless steel
- Seat angle adjustment via gas pressure spring:
130N (Size 0), 200N (Sizes 1-3) and 2x 130N (Size 4)
- Mechanical height adjustment
- 4 dual castors (100 mm) with locking devices



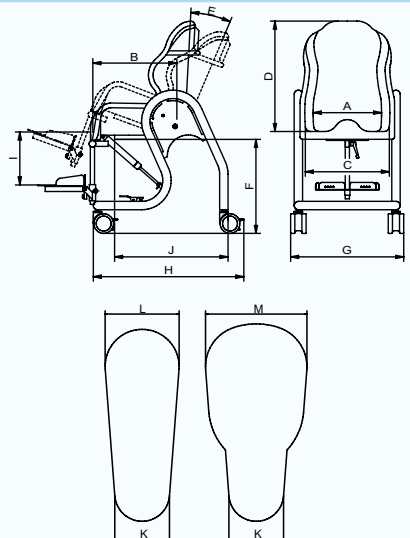

HMV-No.: 33.40.04.2008

Dimensions - basic model

		Size 0	Size 1	Size 2	Size 3	Size 4
A	Seat width (rear)	26 cm	31 cm	36 cm	41 cm	46 cm
B	Seat depth	31 cm	36 cm	41 cm	46 cm	48 cm
C	Seat shell width (front)	31 cm	36 cm	41 cm	46 cm	51 cm
D	Back height	49 cm	51 cm	56 cm	61 cm	65 cm
E	Tilt-in-space	(-)5° - 30°	(-)5° - 30°	(-)5° - 30°	(-)5° - 30°	(-)5° - 30°
F	Can be positioned over a toilet	47 - 57 cm	45 - 55 cm	42 - 52 cm	42 - 52 cm	42 - 52 cm
G	Total width	56 cm	61 cm	63 cm	71,5 cm	74 cm
H	Total length	65 cm	65 cm	65 cm	70 cm	70 cm
I	Max. lower leg length	38 cm	38 cm	48 cm	48 cm	48 cm
J	Front edge of hygiene opening to back edge of subframe	47 cm	49 cm	51 cm	54 cm	57 cm
K	Front opening width	10 cm	10 cm	10 cm	10 cm	10 cm
L	Rear opening width	12 cm	12 cm	13,5 cm	13,5 cm	13,5 cm
M*	Rear opening width	-	-	18,5 cm	18,5 cm	18,5 cm
	Max. load	60 kg	80 kg	100 kg	100 kg	150 kg
	Weight	28 kg	30 kg	33 kg	35 kg	38 kg

*** only applies to Sizes 2 b, 3 b and 4 b**

Basic model				
boris. size 0	boris. size 1	boris. size 2	boris. size 3	boris. size 4
Price / piece	Price / piece	Price / piece	Price / piece	Price / piece
<input type="checkbox"/> 52 00 100 2.176 €	<input type="checkbox"/> 52 01 100 2.197 €	<input type="checkbox"/> Size 2a (52 02 100/A) 2.197 € <input type="checkbox"/> Size 2b (52 02 200/A) 2.263 €	<input type="checkbox"/> Size 3a (52 03 100/A) 2.263 € <input type="checkbox"/> Size 3b (52 03 200/A) 2.328 €	<input type="checkbox"/> Size 4a (52 04 100/A) 2.456 € <input type="checkbox"/> Size 4b (52 04 200/A) 2.534 €

Accessories			
<p>PU-Headrest – blue, adjustable in height and depth with stainless steel bracket</p> 	<p>PU insert pad – two-piece for opening form a</p> 	<p>PU insert pad – two-piece for opening form b</p> 	<p>Tray – with padded arm rest segment and holder</p> 
Price / piece	Price / piece	Price / piece	Price / piece
<input type="checkbox"/> 52 00 001 221 €	<input type="checkbox"/> for size 0 (52 00 101) 314 € <input type="checkbox"/> for size 1 (52 01 101) 314 € <input type="checkbox"/> for size 2 (52 02 101) 314 € <input type="checkbox"/> for size 3 (52 03 101) 314 € <input type="checkbox"/> for size 4 (52 04 101) 314 €	<input type="checkbox"/> for size 2 (52 02 201) 353 € <input type="checkbox"/> for size 3 (52 03 201) 353 € <input type="checkbox"/> for size 4 (52 04 201) 353 €	<input type="checkbox"/> for size 0 (52 00 012) 358 € <input type="checkbox"/> for size 1 (52 01 002) 358 € <input type="checkbox"/> for size 2 (52 02 002) 358 € <input type="checkbox"/> for size 3 (52 03 002) 358 € <input type="checkbox"/> for size 4 (52 04 002) 358 €

Accessories																								
<p>Toilet bucket – incl. lid and bracket as assembly set</p> 	<p>Abductor wedge – with integrated splash guard (Note: a subsequent assembly at size 4 has to take place in our factory)</p> 	<p>Footplate – height, knee and foot angle adjustment, also folding</p> 	<p>PU-Calf plate – height adjustable (only for use in combination with the footplate)</p> 																					
	<table border="1"> <thead> <tr> <th></th> <th>Width</th> <th>Height from seat</th> </tr> </thead> <tbody> <tr> <td>for size 0+1</td> <td>7 cm</td> <td>14 cm</td> </tr> <tr> <td>for size 2-4</td> <td>8 cm</td> <td>17,5 cm</td> </tr> </tbody> </table>		Width	Height from seat	for size 0+1	7 cm	14 cm	for size 2-4	8 cm	17,5 cm	<table border="1"> <thead> <tr> <th></th> <th>Adjustable lower leg length</th> </tr> </thead> <tbody> <tr> <td>for size 0+1</td> <td>30 - 38 cm</td> </tr> <tr> <td>for size 2-4</td> <td>35 - 48 cm</td> </tr> </tbody> </table>		Adjustable lower leg length	for size 0+1	30 - 38 cm	for size 2-4	35 - 48 cm	<table border="1"> <thead> <tr> <th></th> <th>Height</th> <th>Width</th> </tr> </thead> <tbody> <tr> <td></td> <td>15 cm</td> <td>38 cm</td> </tr> </tbody> </table>		Height	Width		15 cm	38 cm
	Width	Height from seat																						
for size 0+1	7 cm	14 cm																						
for size 2-4	8 cm	17,5 cm																						
	Adjustable lower leg length																							
for size 0+1	30 - 38 cm																							
for size 2-4	35 - 48 cm																							
	Height	Width																						
	15 cm	38 cm																						
Price / set	Price / piece	Price / piece	Price / piece																					
<input type="checkbox"/> for size 0+1+3 (52 00 102) 162 € <input type="checkbox"/> for size 2+4 (52 02 102) 162 €	<input type="checkbox"/> for size 0+1 (52 01 103) 172 € <input type="checkbox"/> for size 2+4 (52 02 103) 172 € <input type="checkbox"/> for size 3 (52 03 103) 172 €	<input type="checkbox"/> for size 0+1 (52 01 004) 309 € <input type="checkbox"/> for size 2-4 (52 02 004) 309 €	<input type="checkbox"/> 52 01 009 194 €																					

Accessories		Strap holder			
<p>Positioning jacket – made of spacer fabric incl. strap holder for shoulder straps, colour: blue</p> 	<p>Pelvic harness – made of spacer fabric, colour: blue</p> 	<p>Strap holder – for shoulder straps when using other harnesses apart from the adjacent positioning jacket</p> 			
Price / set	Price / piece	Art.-No.	Use	Max. shoulder width	Price / piece
<input type="checkbox"/> Size 1 (52 01 010) 238 € <input type="checkbox"/> Size 2 (52 02 010) 238 € <input type="checkbox"/> Size 3 (52 03 010) 238 €	<input type="checkbox"/> Size 1 (52 01 011) 100 € <input type="checkbox"/> Size 2 (52 02 011) 100 € <input type="checkbox"/> Size 3 (52 03 011) 100 €	<input type="checkbox"/> 52 01 005 <input type="checkbox"/> 52 01 008	with Headrest without Headrest	30 cm 30 cm	100 € 100 €

Invoice address:

Dispatch address: See invoice address

 Order
 Cost estimate

Customer No.: _____

Orderer: _____

Date: _____

Signature: _____

Commission:
The universal toilet seat system.

- Usable as an attachment on the toilet, with subframe freestanding or as a shower chair
- Incl. pelvic harness and removable armrests
- Adjustable seat depth and back angle

HMV-No.: 33.40.01.4005
(use as a toilet attachment)

HMV-No.: 33.40.04.1008
(use as a toilet chair)



Basic model			
	hts. size 1	hts. size 2	hts. size 3
	Price / piece	Price / piece	Price / piece
<input type="checkbox"/> 57 01 000 (Z111)	942 €	<input type="checkbox"/> 57 02 000 (Z121)	942 €
		<input type="checkbox"/> 57 03 000 (Z131)	1.025 €

Bases		
Mobile subframe hts. – incl. footplate and 75 mm castors (with locking device and directional lock), adjustable in height, with seat angle adjustment (-)5° - 25° 	Mobile subframe hts. – incl. footplate and 75 mm castors (with locking device and directional lock), adjustable in height, with seat angle adjustment (-)15° - 15° 	Fixed subframe hts. incl. footplate, adjustable in height 
Price / piece	Price / piece	Price / piece
<input type="checkbox"/> for size 1 (57 01 025) (Z166) 1.258 € <input type="checkbox"/> for size 2 (57 02 025) (Z167) 1.258 € <input type="checkbox"/> for size 3 (57 03 025) (Z168) 1.258 €	<input type="checkbox"/> for size 1 (57 01 002) (Z166+Z169) 1.258 € <input type="checkbox"/> for size 2 (57 02 002) (Z167+Z169) 1.258 € <input type="checkbox"/> for size 3 (57 03 002) (Z168+Z169) 1.258 €	<input type="checkbox"/> for size 1 (57 01 026) (Z184) 950 € <input type="checkbox"/> for size 2 (57 02 026) (Z185) 950 € <input type="checkbox"/> for size 3 (57 03 026) (Z186) 950 €

Subframes

Transfer and care subframe hts. – made of stainless steel, powder-coated, incl. footplate and 100-mm double castors, height-adjustable. With the transfer and care subframe HTS, we provide a further subframe for the Rifton HTS shower and toilet chair in order to better fulfil the transfer and care requirements of the user and their assistant. With the help of a pedal on both sides of the subframe the height can be adjusted. The seat can simply be tucked forward and backwards.

	for size 1+2	for size 3
Width	67cm	71cm
Length	84cm	87cm
Tilt-in-space	(-)5° - 25°	(-)5° - 25°
Seat height	51 - 78 cm	51 - 78 cm
Lower leg length	27 - 40cm	40 - 53cm
	Price / piece	
<input type="checkbox"/> for size 1+2 (57 01 030)	2.547 €	
<input type="checkbox"/> for size 3 (57 03 030)	2.757 €	

Subframe

Bath subframe hts. – not possible for size 3, only for use without footplate

Width (bottom / top)	41 / 49 cm
Length	58 cm
Height (front)	25 cm
	Price / piece
<input type="checkbox"/> for size 1+2 (57 01 003) (Z138)	344 €

Accessories

Attachment bar – to mount on the toilet (standard configuration, if a subframe Width (bottom / top) 41 / 49 cm has not been selected)



<input type="checkbox"/> for size 1+2 (57 01 004) (Z115)	163 €
<input type="checkbox"/> for size 3 (57 03 004) (Z135)	163 €

Dimensions - basic model

		Size 1	Size 2	Size 3	
A	Width	Mobile subframes	53cm	53cm	57cm
		Fixed subframes	51cm	51cm	53cm
		Transfer and care subframe	67 cm	67cm	71cm
B	Seat height	Mobile subframes	39 - 55 cm	39 - 55 cm	44 - 58 cm
		Fixed subframes	33 - 43 cm	36 - 44 cm	38 - 48 cm
		Transfer and care subframe	51 - 78 cm	51 - 78 cm	51 - 78 cm
C	Seat width	20*/25*/30cm	25*/30*/36cm	33*/38*/43cm	
D	Seat depth	20/23/25/28 cm	29/32/34/37 cm	37/40/42/44 cm	
E	Armrest height	13.5cm	17cm	20 cm	
F	Back width	29 cm	34 cm	41cm	
G	Lower leg length toilet seat	22 - 34 cm	27 - 39 cm	34 - 44 cm	
H	Back height	42cm	50 cm	62 cm	
I	Max. position above toilet height	Mobile subframes	52 cm	52 cm	52.5 cm
		Fixed subframes	38 cm	38 cm	42 cm
J	Length	Mobile subframes	74 cm	74 cm	81 cm
		Fixed subframes	71 cm	71 cm	74 cm
		Transfer and care subframe	84 cm	84 cm	87 cm
K	Front edge of hygiene opening to back edge of subframe	48 cm	48 cm	48 cm	
	Back angle	(-)6°, 6°, 18°	(-)6°, 6°, 18°	(-)6°, 6°, 18°	
	Tilt-in-space	(-)5° - 25°	(-)5° - 25°	(-)5° - 25°	
		(-)15° - 15°	(-)15° - 15°	(-)15° - 15°	
	Max. load	34 kg	68 kg	113 kg	

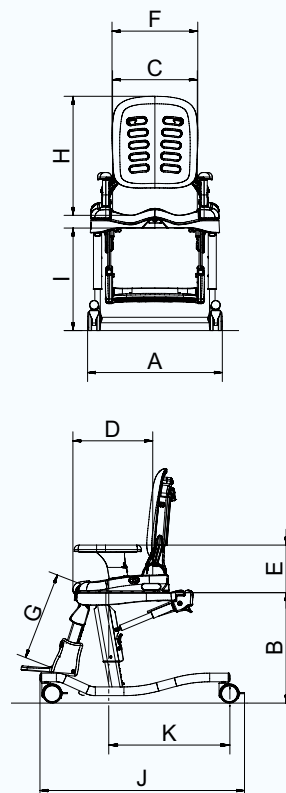

* adjustable with optional thigh guide



Arm rests

	Arm rests for size 1 – detachable (standard configuration for size 1, if nothing else stated)		Arm rests for size 1-3 – detachable (standard configuration for size 2, if nothing else stated)		Arm rests for size 2+3 – detachable (standard configuration for size 3, if nothing else stated)	
	Height	13,5cm	Height	17cm	Height	20 cm
	Price / pair		Price / pair		Price / pair	
	<input type="checkbox"/> 57 01 001 (Z101)	incl.	<input type="checkbox"/> 57 02 001 (Z102)	incl.	<input type="checkbox"/> 57 03 001 (Z103)	incl.





Padding
Additional seat pad



Back pad and seat pad (closed at back)		Back pad und seat pad (open at back)		Back pad und seat pad (completely closed)		Seat pad (completely closed)	
							
Hole size in seat pad		Hole size in seat pad					
for size 1	8x20cm	for size 1	10x23cm				
for size 2	9x25cm	for size 2	11x30cm				
for size 3	11x30cm	for size 3	15x36cm				
Price / set		Price / set		Price / set		Price / piece	
<input type="checkbox"/> for size 1 (57 01 013) (Z154)	327 €	<input type="checkbox"/> for size 1 (57 01 012) (Z153)	327 €	<input type="checkbox"/> for size 1 (57 01 028) (Z187)	392 €	<input type="checkbox"/> for size 1 (57 01 029) (Z191)	221 €
<input type="checkbox"/> for size 2 (57 02 013) (Z164)	327 €	<input type="checkbox"/> for size 2 (57 02 012) (Z163)	327 €	<input type="checkbox"/> for size 2 (57 02 028) (Z188)	392 €	<input type="checkbox"/> for size 2 (57 02 029) (Z192)	221 €
<input type="checkbox"/> for size 3 (57 03 013) (Z174)	327 €	<input type="checkbox"/> for size 3 (57 03 012) (Z173)	327 €	<input type="checkbox"/> for size 3 (57 03 028) (Z189)	392 €	<input type="checkbox"/> for size 3 (57 03 029) (Z193)	221 €

Accessories

	Shaped headrest – height, angle and depth adjustable		Lateral pads – width and height adjustable				
			Size 1	Size 2			
	Height		10 cm	13 cm			
	Depth		13 cm	17 cm			
		to suit	Size 1+2	Size 2+3			
		Chest width for size 1	15 – 28cm				
		Chest width for size 2	19 – 32cm				
		Chest width for size 3	28 – 42cm				
Price / piece				Price / pair		Price / piece	
<input type="checkbox"/> 57 00 006 (Z104)		344 €		<input type="checkbox"/> Size 1 (57 01 007) (Z105)	290 €	<input type="checkbox"/> for size 1 (57 01 009) (Z116)	229 €
				<input type="checkbox"/> Size 2 (57 02 007) (Z106)	290 €	<input type="checkbox"/> for size 2 (57 02 009) (Z126)	229 €
				<input type="checkbox"/> Size 1 with additional chest strap (57 01 008) (Z107)	344 €	<input type="checkbox"/> for size 3 (57 03 009) (Z136)	229 €
				<input type="checkbox"/> Size 2 with additional chest strap (57 02 008) (Z108)	344 €		

Accessories

	Thigh guides width adjustable				
	Pad height	Pad width			
	57 00 010	7,5cm / 18cm			
	57 01 010	7,5cm / 28cm			
Price / pair		Price / piece		Price / piece	
<input type="checkbox"/> for size 1-3 (57 00 010) (Z109)	156 €	<input type="checkbox"/> for size 1 (57 01 011) (Z145)	359 €	<input type="checkbox"/> for size 1+2 (57 01 014) (Z118)	68 €
<input type="checkbox"/> for size 2+3 (57 01 010) (Z149)	175 €	<input type="checkbox"/> for size 2 (57 02 011) (Z155)	359 €	<input type="checkbox"/> for size 3 (57 03 014) (Z128)	68 €
		<input type="checkbox"/> for size 3 (57 03 011) (Z165)	359 €		

Accessories			
<p>Abductor wedge</p> 			<p>Toilet bucket</p> 
		Price / piece	Price / piece
<input type="checkbox"/> for size 1+2 (57 01 016) (Z124)	160 €	<input type="checkbox"/> for size 1 (57 01 017) (Z117)	114 €
<input type="checkbox"/> for size 3 (57 03 016) (Z144)	160 €	<input type="checkbox"/> for size 2 (57 02 017) (Z127)	114 €
		<input type="checkbox"/> for size 3 (57 03 017) (Z137)	114 €

Accessories			
<p>Footplate – when used as a toilet attachment (already included with the mobile subframe)</p> 	<p>Calf guide – only for use with the footplate</p> 	<p>Ankle cuffs – only for use with the footplate</p> 	
		Price / piece	Price / pair
<input type="checkbox"/> for size 1 (57 01 018) (Z146)	437 €	<input type="checkbox"/> for size 1+2 (57 01 019) (Z158)	90 €
<input type="checkbox"/> for size 2 (57 02 018) (Z147)	437 €	<input type="checkbox"/> for size 3 (57 03 019) (Z159)	90 €
<input type="checkbox"/> for size 3 (57 03 018) (Z148)	437 €	<input type="checkbox"/> for size 1+2 (57 01 020) (Z156)	104 €
		<input type="checkbox"/> for size 3 (57 03 020) (Z157)	104 €

Accessories			
<p>Push handles – for mobile subframes</p> 			<p>Castors 100mm – for mobile subframes</p> 
		Price / pair	Upcharge / set
<input type="checkbox"/> 57 00 030 (Z199)	196 €	<input type="checkbox"/> 57 00 031	130 €

Accessories	
<p>Travel base hts. – with bag, max. toilet height = 47 cm, not possible for size 3, only for use without footplate (only for temporary use when traveling)</p> 	
Price / piece	
<input type="checkbox"/> for size 1+2 (57 01 022) (Z139)	644 €

Invoice address:

Dispatch address: See invoice address

Order
 Cost estimate

Customer No.: _____
 Orderer: _____
 Date: _____
 Signature: _____

Commission:

The bathing and shower cradle.

- UV-resistant plastic frame with removable cover
- Seat and back section with adjustable angle
- Back angle adjustable with practical single hand operation
- Two heights possible via adjustable feet



HMV-No.: 04.40.04.0007

Basic model



wave. size 1 - 3 standard		wave. size 1 - 3 with angle adjustable calf rest	
	Price / piece		Price / piece
<input type="checkbox"/> Size 1 (58 01 000) (Z211)	790 €	<input type="checkbox"/> Size 1 (58 01 100) (Z211+Z216)	880 €
<input type="checkbox"/> Size 2 (58 02 000) (Z221)	840 €	<input type="checkbox"/> Size 2 (58 02 100) (Z221+Z226)	930 €
<input type="checkbox"/> Size 3 (58 03 000) (Z231)	900 €	<input type="checkbox"/> Size 3 (58 03 100) (Z231+Z236)	990 €

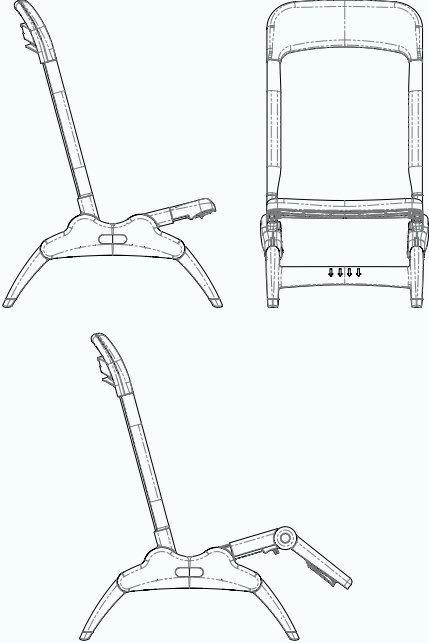

Basic model incl. accessory pack

wave size 1 - 3 standard, incl. headrest, pelvis strap and leg straps		wave size 1 - 3 with angle adjustable calf rest, incl. headrest, pelvis strap and leg straps	
	Price / piece		Price / piece
<input type="checkbox"/> Size 1 (58 01 050) (Z211+Z214+Z213+Z215)	890 €	<input type="checkbox"/> Size 1 (58 01 150) (Z211+Z214+Z213+Z215+Z216)	980 €
<input type="checkbox"/> Size 2 (58 02 050) (Z221+Z214+Z223+Z225)	1.040 €	<input type="checkbox"/> Size 2 (58 02 150) (Z221+Z214+Z223+Z225+Z226)	1.130 €
<input type="checkbox"/> Size 3 (58 03 050) (Z231+Z234+Z233+Z235)	1.100 €	<input type="checkbox"/> Size 3 (58 03 150) (Z231+Z234+Z233+Z235+Z236)	1.190 €

Cover colours			
Blue		Pink	
Price / piece		Price / piece	
<input type="checkbox"/> 9100300 (BLU)	incl.	<input type="checkbox"/> 9100301 (PNK)	incl.

Dimensions - basic model					
	Size 1	Size 2	Size 3		
Seat depth	27 cm	33 cm	43 cm		
Seat width	38 cm	38 cm	44 cm		
Back height	58 cm	67 cm	81 cm		
Seat height	5 cm / 18 cm	5 cm / 18 cm	5 cm / 18 cm		
Seat height with bath cradle subframe	32 - 47 cm	32 - 47 cm	32 - 47 cm		
Seat height with shower cradle subframe	70 cm	70 cm	70 cm		
Seat height with transfer subframe	53 - 75 cm	53 - 75 cm	53 - 75 cm		
Length of bathing cradle, completely flat, without calf pad	89 cm	104 cm	128 cm		
Length of bathing cradle, completely flat, with calf pad	108 cm	124 cm	155 cm		
Width	46 cm	46 cm	53 cm		
Length, completely flat	75 cm	75 cm	75 cm		
Height of bath subframe	20 cm	20 cm	20 cm		
Length of bath subframe	99 cm	99 cm	99 cm		
Width of bath subframe	44 cm	44 cm	44 cm		
Height of shower subframe	56 cm	56 cm	56 cm		
Width of shower subframe	69 cm	69 cm	69 cm		
Length of shower subframe	86 cm	86 cm	86 cm		
Max. load	34 kg	68 kg	114 kg		
Back and seat angle	0°, 15°, 30°, 45°, 60°, 75°	0°, 15°, 30°, 45°, 60°, 75°	0°, 15°, 30°, 45°, 60°, 75°		

Subframes		
Bath subframe wave. to increase the bathing height 	Shower cradle subframe wave. mobile with 4 x 100 mm dual castors with brakes 	Transfer subframe wave. – mobile with 4 castors (2 with brakes), pivots to the right (by means of conversion also pivotable to the left), foldable, incl. wall hook to hang it on the wall. (we recommend the use in combination with a bathing and shower cradle with calf rest) 
Price / piece	Price / piece	Price / piece
<input type="checkbox"/> 5800500 (Z217) 560 €	<input type="checkbox"/> 5800510 (Z218) 1.190 €	<input type="checkbox"/> 5800520 (Z227 + Z265) 1.380 €

Accessories			
Headrest / torso support 	Chest strap / pelvis strap 	Chest strap with lateral positioning 	Leg straps 
Price / piece	Price / piece	Price / piece	Price / piece
<input type="checkbox"/> for size 1+2 (5801001) (Z214) 125 € <input type="checkbox"/> for size 3 (5803001) (Z234) 125 €	<input type="checkbox"/> for size 1 (5801002) (Z213) 80 € <input type="checkbox"/> for size 2 (5802002) (Z223) 80 € <input type="checkbox"/> for size 3 (5803002) (Z233) 80 €	<input type="checkbox"/> for size 1 (5801003) (Z212) 100 € <input type="checkbox"/> for size 2 (5802003) (Z222) 100 € <input type="checkbox"/> for size 3 (5803003) (Z232) 100 €	<input type="checkbox"/> for size 1 (5801004) (Z215) 80 € <input type="checkbox"/> for size 2 (5802004) (Z225) 80 € <input type="checkbox"/> for size 3 (5803004) (Z235) 80 €

Invoice address:**Dispatch address:**
 See invoice address

 Order
 Cost estimate

Customer No.: _____

Orderer: _____

Date: _____

Signature: _____

Commission:**The versatile bathing and shower cradle.**

- Black, powder-coated frame with removable, washable cover
- Incl. back angle, knee angle and head angle adjustment
- Incl. chest strap

HMV-No.: 04.40.04.0006

Dimensions - basic model

		Size 1	Size 2	Size 3	Size 4
A	Seat width	30cm	35cm	35cm	40cm
B	Seat depth	30cm	34cm	38cm	44cm
C	Back height	45cm	61cm	71cm	82cm
D	Standing space length	69cm	74cm	88cm	93cm
E	Lower leg length	19cm	20cm	28cm	28cm
F	Total width	36cm	41cm	41cm	46cm
	Back angle	90° - 180°	90° - 180°	90° - 180°	90° - 180°
	Knee angle	0° - 90°	0° - 90°	0° - 90°	0° - 90°
	Headrest angle	0° - 90°	0° - 90°	0° - 90°	0° - 90°
	Seat height	0° / 5cm	0° / 5cm	0° / 5cm	0° / 5cm
	Max. load	35kg	45kg	55kg	75kg
	Weight	4kg	4.1kg	4.3kg	4.8kg

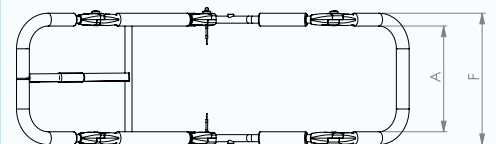
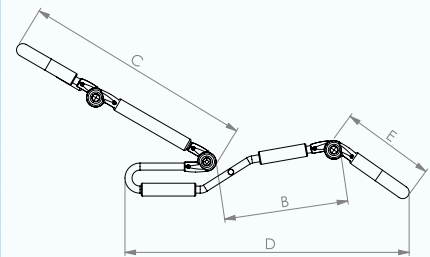

Basic model			
basti. size 1	basti. size 2	basti. size 3	basti. size 4 back angle adjustment via stainless steel ratchet joint
Price / piece	Price / piece	Price / piece	Price / piece
<input type="checkbox"/> 56 01 000 892 €	<input type="checkbox"/> 56 02 000 948 €	<input type="checkbox"/> 56 03 000 999 €	<input type="checkbox"/> 56 04 000 1.132 €

Accessories			
Cover with hollow for pelvis and adjustable tube edge 		Head guide pad – adjustable with velcro 	
Upcharge / piece		Price / piece	
<input type="checkbox"/> for size 1 (56 01 001)	144 €	<input type="checkbox"/> for size 1 (56 01 002)	236 €
<input type="checkbox"/> for size 2 (56 02 001)	144 €	<input type="checkbox"/> for size 2 (56 02 002)	236 €
<input type="checkbox"/> for size 3 (56 03 001)	171 €	<input type="checkbox"/> for size 3 (56 03 002)	236 €
<input type="checkbox"/> for size 4 (56 04 001)	171 €	<input type="checkbox"/> for size 4 (56 04 002)	236 €

Accessories			
Additional retainer strap – adjustable with velcro for the chest or pelvis 		Shower cradle subframe basti. – mobile with 4 castors with brakes 	
Price / piece		Price / piece	
<input type="checkbox"/> for size 1 (56 01 003)	114 €	<input type="checkbox"/> 56 00 200	785 €
<input type="checkbox"/> for size 2+3 (56 03 003)	114 €		
<input type="checkbox"/> for size 4 (56 04 003)	114 €		

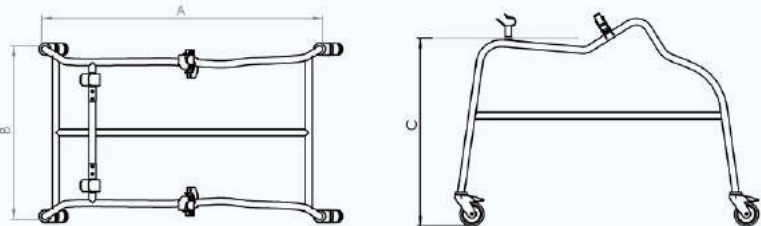
Dimensions - subframe		
A	Length	92 cm
B	Width	57 cm
C	Seat height with subframe	61* / 66 cm
	* in combination with the cover with pelvic mould depression	
		

Invoice address:**Dispatch address:**
 See invoice address

 Order
 Cost estimate

Customer No.: _____

Orderer: _____

Date: _____

Signature: _____

Commission:**The lightweight and compact bathing seat.**

- Aluminium frame with removable cover
- Back section with adjustable angle
- Incl. pelvic harness

Dimensions - basic model

		bibi.	bibi. with long back
A	Seat depth	30 cm	30 cm
B	Seat width	36 cm	36 cm
C	Back height	45 cm	55 cm
D	Total length	60 cm	60 cm
	Back angle	90° - 180°	90° - 180°
	Max. load	30 kg	30 kg
	Weight	2.3 kg	2.3 kg

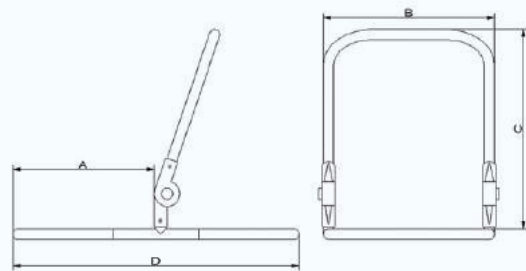
Basic model

bibi.	Price / piece	bibi. with long back	Price / piece
<input type="checkbox"/> 5501000	434 €	<input type="checkbox"/> 5501001	461 €

Accessories
Additional pelvic harness

<input type="checkbox"/> 5501002	Price / piece	114 €
---	---------------	-------

Name embroidery.

Invoice address:

 Order
 Cost estimate

Customer No.: _____

Orderer: _____

Date: _____

Signature: _____

Dispatch address: See invoice address

Commission:

We hereby offer a way of customizing our aids **smilla.**, **sofie.**, **madita.**, **madita-fun.** and **madita-fun mini.** You can provide the respective back pad with the name of the user.

Simply assign the name embroidery to the product and tell us the desired name. Then you have to only send this form together with the order form of the particular product and you will receive the ordered product with the desired name on the back pad.

- The height of the embroidery is 2.5cm (2cm for **madita-fun mini.**) – width is therefore given by the length of the name
- The embroidery is placed on the right side of the back pad (in the middle at **madita-fun mini.**)
- For the embroidery we use a silver-white yarn
- You can see the font that is used for the embroidery in the accompanying picture



Note: an embroidery of our flexi fabric is not possible

Configuration name embroidery	
Indication of the name please in BLOCK LETTERS (max. 12 letters)	<input type="text"/> <input type="text"/> <input type="text"/> <input type="text"/> <input type="text"/> <input type="text"/> <input type="text"/> <input type="text"/> <input type="text"/> <input type="text"/> <input type="text"/> <input type="text"/> <input type="text"/>
Product assignment	<input type="checkbox"/> smilla. <input type="checkbox"/> sofie.
	<input type="checkbox"/> madita. <input type="checkbox"/> madita-fun.
	<input type="checkbox"/> madita-fun mini.

Flexi-activ harnesses.

Invoice address:
Dispatch address:
 See invoice address

 Order
 Cost estimate

Customer No.: _____

Orderer: _____

Date: _____

Signature: _____

Commission:

Straps made of elastic, skin-friendly, breathable and moisture-repellent flexi material

Configure the strapping as individually as you need it!

Chest-shoulder strap
Chest-shoulder strap (girl shape)

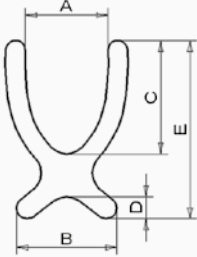
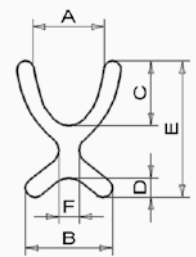
	Size 1	Size 2	Size 3	Size 4			Size 2	Size 3	Size 4	
A	13cm	18cm	18cm	20cm		A	18cm	18cm	19cm	
B	19cm	20cm	21cm	22cm		B/F	24 / 6cm	25 / 7cm	27 / 7cm	
C	15cm	19cm	28cm	30cm		C	17cm	21cm	27cm	
D	5cm	5cm	5cm	6cm		D	5cm	6cm	7cm	
E	28cm	34cm	44cm	52cm		E	35cm	44cm	52cm	

Price / piece

Price / piece

<input type="checkbox"/> Chest-shoulder strap Size 1	(60 01 001)	160 €	<input type="checkbox"/> Chest-shoulder strap (girl shape) Size 2	(60 02 002)	160 €
<input type="checkbox"/> Chest-shoulder strap Size 2	(60 02 001)	160 €	<input type="checkbox"/> Chest-shoulder strap (girl shape) Size 3	(60 03 002)	160 €
<input type="checkbox"/> Chest-shoulder strap Size 3	(60 03 001)	160 €	<input type="checkbox"/> Chest-shoulder strap (girl shape) Size 4	(60 04 002)	160 €
<input type="checkbox"/> Chest-shoulder strap Size 4	(60 04 001)	160 €			

Strap configuration
Straps to the shoulder

- firmly sewn with 20 mm strap (standard configuration for size 1+2) **(60 00 020)**
- firmly sewn with 25 mm strap (standard configuration for size 3+4) **(60 01 020)**
- with clip 20 mm **(60 00 021)**
- with clip 25 mm **(60 01 021)**

Straps to the pelvis

- firmly sewn with 20 mm strap (standard configuration for size 1+2) **(60 00 022)**
- firmly sewn with 25 mm strap (standard configuration for size 3+4) **(60 01 022)**
- with clip 20 mm **(60 00 023)**
- with clip 25 mm **(60 01 023)**

Mounting on the back

- Strap with sliding unit (standard configuration) **(60 00 024)**
- Clip buckle + belt loop with eyelet **(60 01 024)**
- Belt with eyelets (only with clip) **(60 02 024)**

Mounting on the seat

- Strap with sliding unit (standard configuration) **(60 00 025)**
- Clip buckle + belt loop with eyelet **(60 01 025)**
- Belt with eyelets (only with clip) **(60 02 025)**

Colour

- Black (standard configuration) **(91 00 040)**
- Light grey **(91 00 049)**

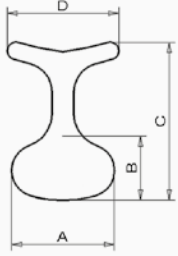
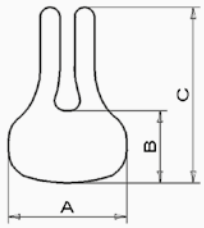
Groin harness (T-shape)					Groin harness (standard)					
										
	Size 0	Size 1	Size 2	Size 3		Size 1	Size 2	Size 3	Size 4	
A	23cm	25cm	28cm	31cm		A	24cm	29cm	33cm	36cm
B	15cm	17cm	20cm	23cm		B	14cm	17cm	22cm	26cm
C	33cm	35cm	38cm	41cm		C	35cm	43cm	49cm	55cm
D	24cm	26cm	28cm	30cm						
					Price / piece	Price / piece				
<input type="checkbox"/> Groin harness (T-shape) Size 0 (60 00 006) 133 € <input type="checkbox"/> Groin harness (T-shape) Size 1 (60 01 006) 133 € <input type="checkbox"/> Groin harness (T-shape) Size 2 (60 02 006) 133 € <input type="checkbox"/> Groin harness (T-shape) Size 3 (60 03 006) 133 €						<input type="checkbox"/> Groin harness (standard) Size 1 (60 01 007) 133 € <input type="checkbox"/> Groin harness (standard) Size 2 (60 02 007) 133 € <input type="checkbox"/> Groin harness (standard) Size 3 (60 03 007) 133 € <input type="checkbox"/> Groin harness (standard) Size 4 (60 04 007) 133 €				
Strap configuration										
Straps in front					Mounting in front					
<input type="checkbox"/> with clip 20 mm (standard configuration for size 0-2) (60 00 026) <input type="checkbox"/> with clip 25 mm (standard configuration for size 3+4) (60 01 026)					<input type="checkbox"/> Strap with sliding unit (standard configuration) (60 00 028) <input type="checkbox"/> Clip buckle + belt loop with eyelet (60 01 028) <input type="checkbox"/> Belt with eyelets (60 02 028)					
Straps at the back					Mounting at the back					
<input type="checkbox"/> firmly sewn with 20 mm strap (standard configuration for size 0-2) (60 00 027) <input type="checkbox"/> firmly sewn with 25 mm strap (standard configuration for size 3+4) (60 01 027)					<input type="checkbox"/> Strap with sliding unit (standard configuration) (60 00 029) <input type="checkbox"/> Clip buckle + belt loop with eyelet (60 01 029)					
Colour										
<input type="checkbox"/> Black (standard configuration) (91 00 040) <input type="checkbox"/> Light grey (91 00 049)										

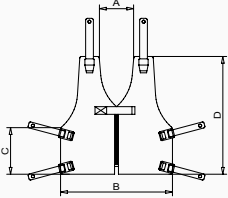
Positioning jacket with zipper															
	Positioning jacket size 1				Positioning jacket size 2				Positioning jacket size 3						
		A	B	C	D		A	B	C	D		A	B	C	D
	Size 1	8cm	26cm	10cm	27cm	Size 2	9cm	29cm	12cm	30cm	Size 3	11cm	35cm	15cm	35cm
	Price / piece				Price / piece				Price / piece						
<input type="checkbox"/> 60 01 005 185 €				<input type="checkbox"/> 60 02 005 185 €				<input type="checkbox"/> 60 03 005 185 €							
Strap configuration															
Straps to the shoulder							Mounting on the back								
<input type="checkbox"/> Firmly sewn (standard configuration) (60 00 030) <input type="checkbox"/> with plug closure 20 mm Strap (60 01 030) <input type="checkbox"/> with plug closure 25 mm Strap (60 02 030) <input type="checkbox"/> with clip 20 mm (60 03 030) <input type="checkbox"/> with clip 25 mm (60 04 030)							<input type="checkbox"/> Strape with sliding unit (standard configuration) (60 00 024) <input type="checkbox"/> Clip buckle + belt loop with eyelet (60 01 024)								
Strape left							Mounting on the back								
<input type="checkbox"/> Firmly sewn mit 20 mm Strap (standard configuration for size 1+2) (60 00 031) <input type="checkbox"/> Firmly sewn mit 25 mm Strap (standard configuration for size 3) (60 01 031) <input type="checkbox"/> with clip 20 mm (60 02 031) <input type="checkbox"/> with clip 25 mm (60 03 031)							<input type="checkbox"/> Strape with sliding unit (standard configuration) (60 00 033) <input type="checkbox"/> Clip buckle + belt loop with eyelet (60 01 033)								
Strape right							Mounting on the back								
<input type="checkbox"/> Firmly sewn mit 20 mm Strap (standard configuration for size 1+2) (60 00 032) <input type="checkbox"/> Firmly sewn mit 25 mm Strap (standard configuration for size 3) (60 01 032) <input type="checkbox"/> with clip 20 mm (60 02 032) <input type="checkbox"/> with clip 25 mm (60 03 032)							<input type="checkbox"/> Strape with sliding unit (standard configuration) (60 00 034) <input type="checkbox"/> Clip buckle + belt loop with eyelet (60 01 034)								
Colour															
<input type="checkbox"/> Black (standard configuration) (91 00 040) <input type="checkbox"/> Light grey (91 00 049)															

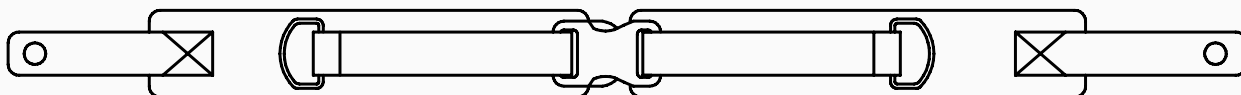
Pelvic harness

Pelvic harness size 1		Pelvic harness size 2		Pelvic harness size 3	
with pad and adjustable clip on both sides		with pad and adjustable clip on both sides		with pad and adjustable clip on both sides	
Pad width	4 cm	Pad width	6 cm	Pad width	6 cm
Pad length per side	18 cm	Pad length per side	25 cm	Pad length per side	30 cm
Strap length per side	30 cm	Strap length per side	35 cm	Strap length per side	40 cm
Price / piece		Price / piece		Price / piece	
<input type="checkbox"/> 60 01 008	80 €	<input type="checkbox"/> 60 02 008	80 €	<input type="checkbox"/> 60 03 008	80 €

Strap configuration

Strape		Mounting on the seat	
<input type="checkbox"/> with clip 25 mm (standard configuration for size 1)	(60 00 035)	<input type="checkbox"/> Strap with sliding unit (standard configuration)	(60 00 025)
<input type="checkbox"/> with clip 40 mm, only size 2+3 (standard config. for size 2+3)	(60 01 035)	<input type="checkbox"/> Clip buckle + belt loop with eyelet	(60 01 025)
Colour			
<input type="checkbox"/> Black (standard configuration)	(91 00 040)		
<input type="checkbox"/> Light grey	(91 00 049)		

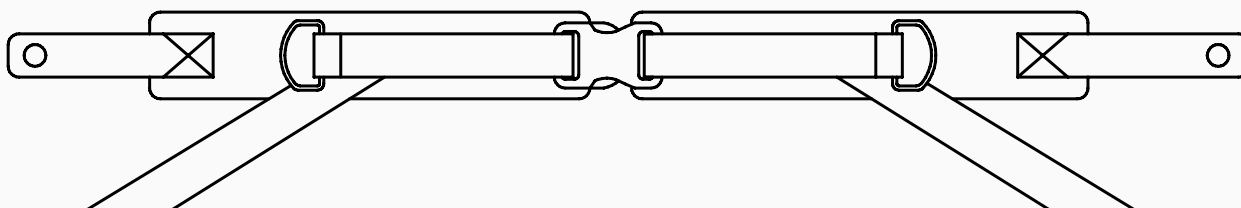
4-point pelvic harness

4-point pelvic harness size 1		4-point pelvic harness size 2		4-point pelvic harness size 3	
with pad and adjustable clip on both sides		with pad and adjustable clip on both sides		with pad and adjustable clip on both sides	
Pad width	4 cm	Pad width	6 cm	Pad width	6 cm
Pad length per side	18 cm	Pad length per side	25 cm	Pad length per side	30 cm
Strap length per side	30 cm	Strap length per side	35 cm	Strap length per side	40 cm
Thigh straps width	2,5 cm	Thigh straps width	2,5 cm	Thigh straps width	2,5 cm
Thigh straps length	55 cm	Thigh straps length	60 cm	Thigh straps length	60 cm
Price / piece		Price / piece		Price / piece	
<input type="checkbox"/> 60 01 009	139 €	<input type="checkbox"/> 60 02 009	139 €	<input type="checkbox"/> 60 03 009	139 €

Strap configuration

Strape		Mounting on the seat	
<input type="checkbox"/> with clip 25 mm (standard configuration for size 1)	(60 00 035)	<input type="checkbox"/> Strap with sliding unit (standard configuration)	(60 00 025)
<input type="checkbox"/> with clip 40 mm, only size 2+3 (Standard. for size 2+3)	(60 01 035)	<input type="checkbox"/> Clip buckle + belt loop with eyelet	(60 01 025)
Colour			
<input type="checkbox"/> Black (standard configuration)	(91 00 040)		
<input type="checkbox"/> Light grey	(91 00 049)		

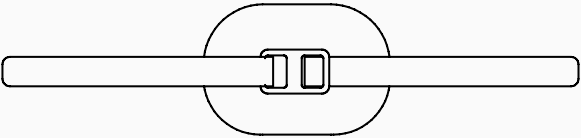
Chest strap		
Chest strap – with clip and pad, colour: black		
		
	Size 1	Size 2
Plug closure	2.0cm	2.5cm
Strap length per side	35cm	40cm
Price / piece		
<input type="checkbox"/> Size 1	(60 01 003)	101 €
<input type="checkbox"/> Size 2	(60 02 003)	101 €
Strap configuration		
Mounting on the back		
<input type="checkbox"/> Strap with sliding unit (standard configuration)	(60 00 024)	
<input type="checkbox"/> Clip buckle + belt loop with eyelet	(60 01 024)	

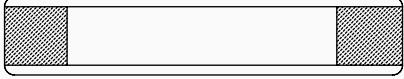
Arm cuff		
Arm cuff – padded, with velcro, colour: black		
		
Width	4 cm	
Length	25 cm	
Price / pair		
<input type="checkbox"/>	60 00 007	145 €

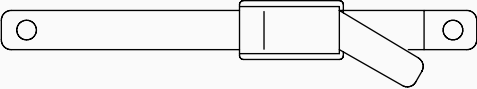
Foot straps		
Foot straps – with eyelets for mounting, colour: black		
		
	Width	Length
with clip buckle	2,5 cm	40 cm
with velcro fastener and idler pulley	2,0 cm	40 cm
Price / pair		
<input type="checkbox"/> with clip buckle	(60 00 012)	38 €
<input type="checkbox"/> with velcro fastener + idler pulley	(60 00 005)	38 €

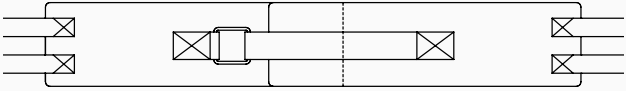
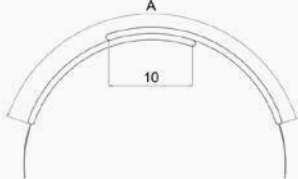
Width Chest strap			
Width Chest strap – padded, velcro fastener with idler pulley, colour: black			
			
			
	Size 1	Size 2	Size 3
Pad width	8 cm	8 cm	10 cm
Strap length per side	20 cm	25 cm	35 cm
Total length (A)	30 cm	40 cm	60 cm
Price / piece			
<input type="checkbox"/> Size 1	(60 01 017)	129 €	
<input type="checkbox"/> Size 2	(60 02 017)	129 €	
<input type="checkbox"/> Size 3	(60 03 017)	129 €	
Strap configuration			
Mounting on the back			
<input type="checkbox"/> Strap with sliding unit (standard configuration)	(60 00 024)		
<input type="checkbox"/> Clip buckle + belt loop with eyelet	(60 01 024)		

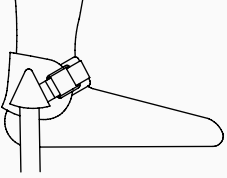
Ankle cuffs		
Ankle cuffs – with velcro fastener and idler pulley, colour: black		
		
	Ankle circumference	Strap width
Size 1	12 - 19 cm	25 mm
Size 2	15 - 23 cm	25 mm
Size 3	19 - 27 cm	40 mm
Price / pair		
<input type="checkbox"/> Size 1	(60 01 010)	190 €
<input type="checkbox"/> Size 2	(60 02 010)	190 €
<input type="checkbox"/> Size 3	(60 03 010)	190 €

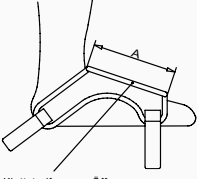
Foot positionern								
 <small>Klettstreifen zum Öffnen</small>	Foot positioner size 1 with 25 mm straps, incl. velcro fastener		Foot positioner size 2 with 25 mm straps, incl. velcro fastener		Foot positioner size 3 with 25 mm straps, incl. velcro fastener			
		A		A		A		
	Size 1	8 cm	Size 2	10 cm	Size 3	13 cm		
	Price / pair			Price / pair				
<input type="checkbox"/>	60 01 011	176 €	<input type="checkbox"/>	60 02 011	176 €	<input type="checkbox"/>	60 03 011	176 €

Assembly set	Eyelet configuration	Customization
Assembly set for foot cuff / foot positioner consisting of 4 clip buckles + belt loop with eyelet	Eyelets for the wet area made of stainless steel	Customization of listed harnesses Please attach dimensions separately
Price / set	Price / piece	Upcharge / piece
<input type="checkbox"/> Width = 25 mm (60 02 015)	<input type="checkbox"/> 60 00 014	<input type="checkbox"/> 60 00 008
<input type="checkbox"/> Width = 40 mm (60 03 015)		
40 €	incl.	109 €

Fabric collection.

Invoice address:

Dispatch address: See invoice address

Order

Cost estimate

Customer No.: _____

Orderer: _____

Date: _____

Signature: _____

Commission:

Our Fabric collection.

Article description	Art.-No.	No.	Quantity	Article description	Art.-No.	No.	Quantity	Price / lfm	Price from 10 lfm	Price from 30 lfm
Trevira CS Stoff				Trevira CS Stoff						
<input type="checkbox"/> Rosa	(90 01 113)	113	_____ m	<input type="checkbox"/> Jeans	(90 01 116)	116	_____ m	31 €	28,10 €	23,75 €
<input type="checkbox"/> Pink-Telemagenta	(90 01 114)	114	_____ m	<input type="checkbox"/> Deep orange	(90 01 107)	107	_____ m			
<input type="checkbox"/> Pink 2	(90 01 115)	115	_____ m	<input type="checkbox"/> Blue, with gray boxes	(90 01 097)	97	_____ m			
<input type="checkbox"/> Azur	(90 01 110)	110	_____ m	<input type="checkbox"/> Blue, with fish, flags, stars, etc.	(90 01 095)	95*	_____ m			
<input type="checkbox"/> Deep sea blue	(90 01 111)	111	_____ m	<input type="checkbox"/> Red, with fish, flags, stars, etc.	(90 01 096)	96*	_____ m			
<input type="checkbox"/> Petrol	(90 01 112)	112	_____ m							
Plain fabric				Plain fabric						
<input type="checkbox"/> Light blue	(90 01 106)	106	_____ m	<input type="checkbox"/> Dark grey	(90 01 092)	92	_____ m	20,50 €	18,45 €	15,40 €
<input type="checkbox"/> Blue	(90 01 088)	88	_____ m	<input type="checkbox"/> Grey, with blue dots	(90 01 117)	117*	_____ m			
<input type="checkbox"/> Apple green	(90 01 089)	89	_____ m	<input type="checkbox"/> Black	(90 01 105)	105	_____ m			
<input type="checkbox"/> Red	(90 01 091)	91	_____ m							
Fabric Flexi, backed										
<input type="checkbox"/> Red	(90 01 045)	45	_____ m					39,10 €	35,30 €	29,45 €
<input type="checkbox"/> Dark blue	(90 01 044)	44	_____ m							
<input type="checkbox"/> Light grey	(90 01 050)	50	_____ m							
<input type="checkbox"/> Black	(90 01 043)	43	_____ m							
Fabric Flexi, unbacked										
<input type="checkbox"/> Red	(90 01 042)	42	_____ m					34,85 €	31,30 €	26,10 €
<input type="checkbox"/> Dark blue	(90 01 041)	41	_____ m							
<input type="checkbox"/> Light grey	(90 01 049)	49	_____ m							
<input type="checkbox"/> Black	(90 01 040)	40	_____ m							
Mesh fabric										
<input type="checkbox"/> Blue	(90 01 046)	46	_____ m					39,10 €	35,30 €	29,45 €
Spacer fabric										
<input type="checkbox"/> Blue, 3mm	(90 01 048)	48*	_____ m					30,50 €	27,90 €	23,30 €
<input type="checkbox"/> Black, 3mm	(90 01 047)	47	_____ m							
Spacer fabric (with closed surface)										
<input type="checkbox"/> Black-grey	(90 01 109)	109	_____ m					31 €	28,10 €	23,75 €
<input type="checkbox"/> Black-black	(90 01 101)	101	_____ m							
Imitation leather (bielastisch)										
<input type="checkbox"/> Black	(90 01 190)	190	_____ m					37 €	33,60 €	27,36 €
Imitation leather										
<input type="checkbox"/> Yellow	(90 01 191)	191	_____ m					30,40 €	27,60 €	22,44 €
<input type="checkbox"/> Green	(90 01 192)	192	_____ m							
<input type="checkbox"/> Red	(90 01 193)	193	_____ m							
<input type="checkbox"/> Blue	(90 01 194)	194	_____ m							

* Phased-out model (only as long as stocks last)

Upgrade your products with our fabrics, as they combine excellent quality with superb design. We provide you with a collection of the latest designs, different materials and the following convincing benefits:

- Simple and easy processing
- Bi-elasticity
- High abrasion resistance
- Widths between 140 and 160 cm, flexi fabrics in 140 cm, spacer fabric in 150 cm
- Tested in accordance with the Oeko-Tex standard 100
- Flame retardant in accordance with DIN EN 1021-1+2
- Skin-compatible in accordance with DIN EN ISO 10993-5
- Fulfills the requirements laid down in the MPG (Medical Products Directive) for your seat shells and special constructions

Trevira CS.



Plain fabric.



Flexi.



Mesh fabric / Spacer fabric.



Imitation leather.



Note:
We reserve the right to carry out design, colour and material modifications according to the latest technology and within the scope of standard market production development. The images of the products and colours merely serve as orientation aids. Due to printing processes, deviations from the original cannot be excluded. All data without guarantee.
* Phased-out model (only as long as stocks last) **unbacked

Cleaning + disinfection.

Introduction to using our products.

Please note that **people with special needs, reading difficulties and impaired vision** must ask a parent, supervisor or technical advisor to read out or explain this technical documentation so that safe usage of our products can be guaranteed.

We would like to point out that only **spare parts and accessories** from our company may be used and installed so as not to endanger the safety of the users. In individual cases, the combination of our products with those of other manufacturers may require clarification with your specialist retailer or with us as the manufacturer.

Settings and adjustments to the product or accessories may only be made by people who have been given the necessary instructions by a medical product advisor. Please ensure that none of the user's extremities are in the respective area when making adjustments of any kind to minimise the risk of injury

The respective product should be reduced to its smallest dimensions **for transportation**. For example, reduce the seat, the armrests, the back etc. to the smallest dimensions. Remove the parts of the product that can be easily removed, e.g. the wheels of the **todd**. standing frame, the handlebars of the **momo**. etc. Fold up the foot support on products with this feature. Please see the User Manual belonging to the respective product for more detailed information.

Instructions for use on the respective products are available on www.schuchmann.de/en/media-library.

If applicable, the **product-specific cleaning guidelines** in the respective instructions for use are to be taken into consideration.

Cleaning guidelines for the different materials.

The care and cleaning of our products should be carried out at regular intervals to ensure that they remain functional over their useful life. The choice of suitable cleaning agents is crucial.

Wood: Wooden parts should be cleaned with a damp cloth or similar. When using detergents, please consult the manufacturer's instructions regarding detergent concentration. Caustic household detergents or corrosive substances are not suitable. Never leave natural wood in a damp or wet condition over long periods, as it will take on water and can change in shape (swelling). Therefore, only wipe and clean damp (i.e. with wrung-out cloths). Test a small, non-visible area for compatibility.

Powder-coated parts: Aluminium parts should be cleaned with a sponge or damp cloth using normal antibacterial household detergents.

Stainless steel: Stainless steel parts should be cleaned using a sponge or damp cloth with a mild soap. Bleach must not be used.

Covers / Fabric: Covers and fabric should be washed at 40° C in the washing machine using normal detergent. Do not tumble dry.

Plastics: Plastics should be cleaned using a sponge or damp cloth with mild soap. Bleach must not be used.

PU (polyurethane): PU parts should only be cleaned using a sponge or damp cloth with a mild soap. Bleach must not be used.

Should you have any queries, you are welcome to contact us directly!



Disinfection measures by material type.

Various products can be used for **surface disinfection** of **metal, wood** and **plastic parts**. The disinfectants used should have a wide range of efficacy (bactericidal, levurocidal and virucidal) and be approved for medical devices.

Suitable disinfectants can be found in the KRINKO/BfArM recommendation.

Liquid disinfectants are available as a ready-to-use solution which is sprayed on and evenly applied with a soft cloth. Alternatively, cloths soaked with disinfectant can be used, with to which the products are wiped all over. In both cases, a complete wetting be respected.

The exposure times may vary and can be found in the manufacturer's instructions for the agents used. However, products based on alcohol should not be used.

Disinfection systems achieve very good results. There the contaminated devices are completely and disinfected by cold fogging. Methods of disinfection by icing are not permitted.

Hygiene measures for all our products.

1. Who should carry out the hygiene measures?

Users or accompanying persons themselves, service staff from specialist dealers and other authorised institutions.

2. How regularly?

- Cleaning: Regularly and as required (in case of soiling)
- Reinigung & Desinfektion: Regularly and as required (in case of possible contamination and before maintenance and servicing)
- Prior to cleaning and disinfection: Damaged sub-frames or components must first be removed or repaired.
- Processing by trained personnel (intensive cleaning and disinfection): Before passing on to other users.



3. With what should the work be carried out?

We recommend wearing protective gloves (e.g. made of nitrile or butyl rubber)! Avoid the penetration of liquids into Bowden cables, frame tubes or similar. Remove visible soiling with a damp sponge cloth and, if necessary, a cleaning agent. Do not use scouring agents or aids!

4. How should the work be conducted exactly?

For cleaning, all accessible surfaces are cleaned with a damp sponge cloth and, if necessary, a suitable cleaning medium. Then dry the surfaces with a cotton or disposable cloth. Hard-to-access places can also be dried using a hairdryer on its lowest setting. The use of high-pressure cleaners is not permitted, as their use can lead to damage to the products.

For disinfection the disinfectant should be used according to the manufacturer's instructions.

Ensure **complete wetting**. If necessary, remove excess preparation quantities with unstained disposable tissue. It is particularly important to observe the exposure times of the manufacturers!



schuchmann.de